

Hydraulic & Pneumatic Connectors
Connectique Hydraulique et Pneumatique
Condutture Idrauliche e Pneumatiche

CONDUCCIONES
HIDRÁULICAS Y NEUMÁTICAS

2020

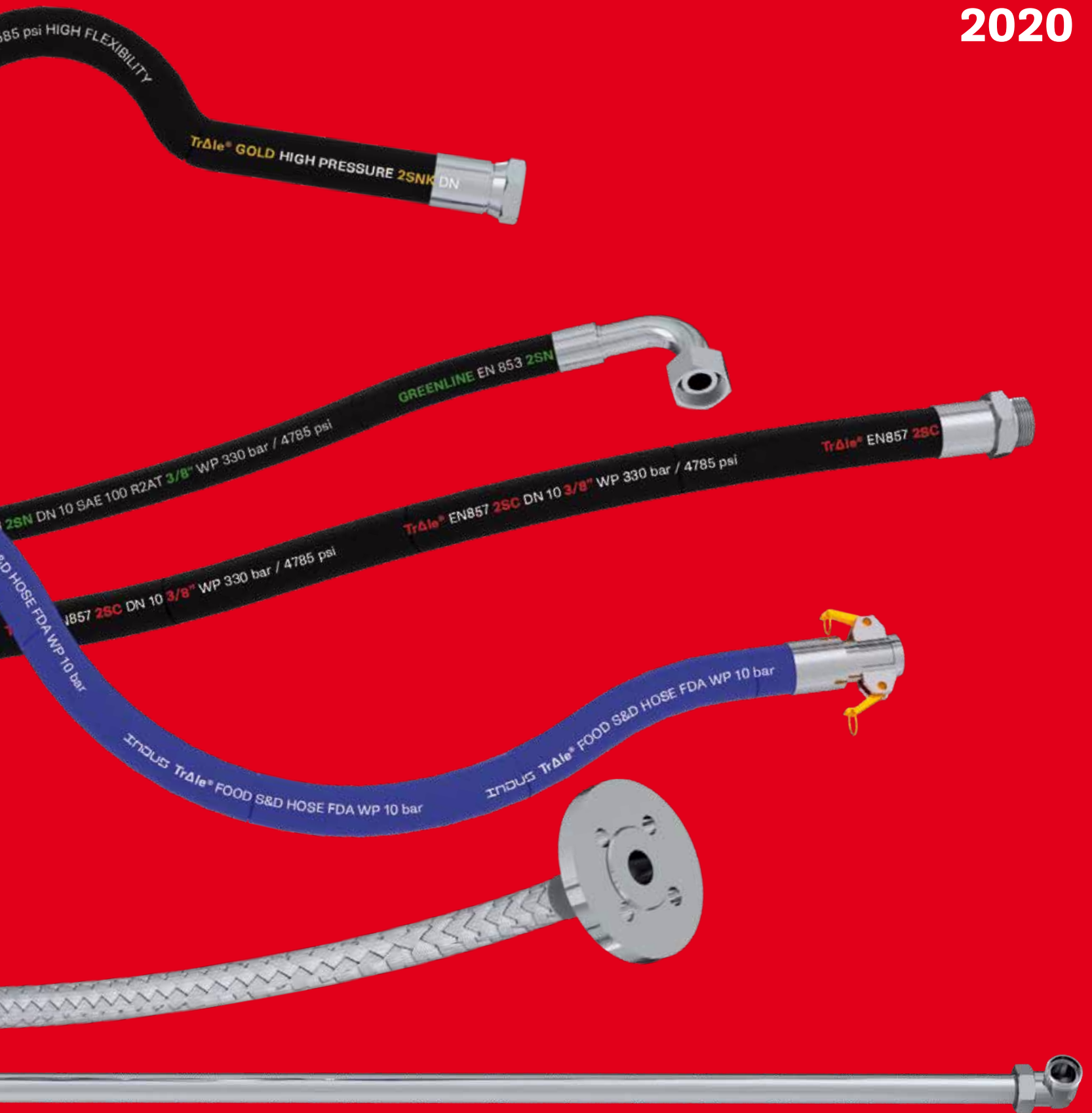

DICSA
www.dicsaes.com

THE BEST WAY TO MANAGE YOUR OWN ORDERS

LA MEJOR FORMA DE GESTIONAR TUS PROPIOS PEDIDOS

www.dicsaes.com

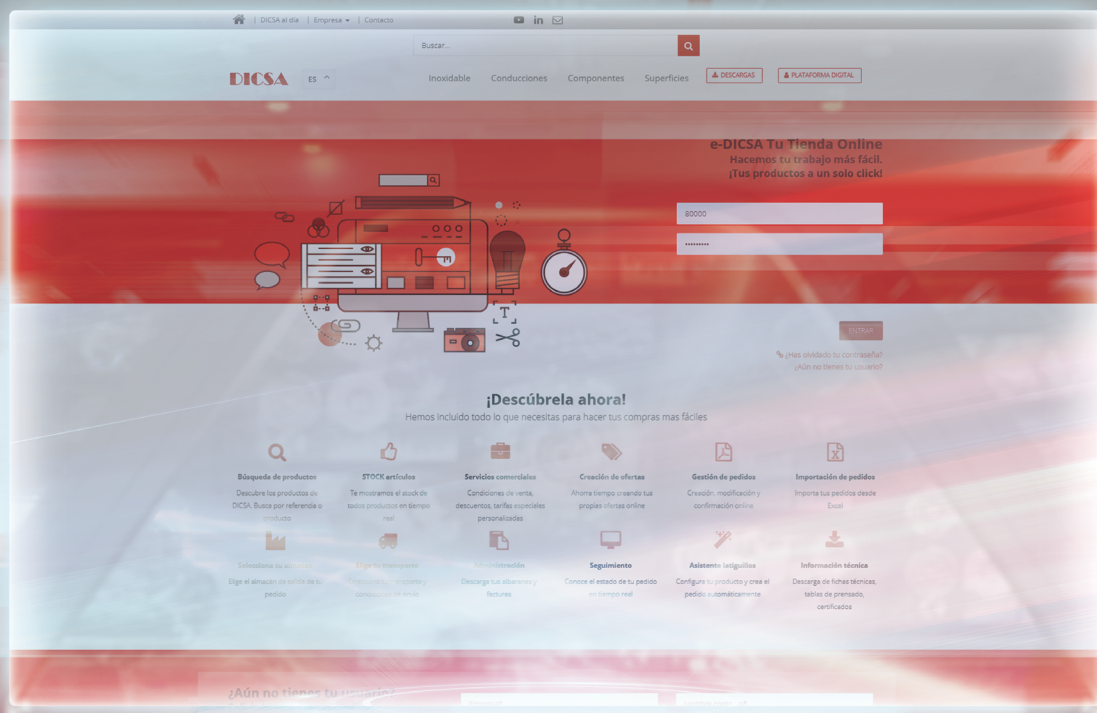

e-DICSA

Crece Contigo · *Grows with you*

DICSA
Creciendo Juntos



SOLICITA TU CONTRASEÑA
comercial@dicsaes.com
export@dicsaes.com
REQUEST YOUR PASSWORD

Flexibles hidráulicos

Flexible connectors

Flexibles hydrauliques

Flessibili idrauliche

TrΔle®



Flexibles Industriales

Industrial Flexible Hoses & Fittings

Flexibles industriels

Tubi flessibili e raccordi industriali

INDUS TrΔle®



Tubo rígido

Pipe connectors

Connectique rigide

Tubo rigido

TrΔle®



Accesorios

Accessories

Accessoires

Accessori

TrΔle®



Conducciones neumáticas

Pneumatic connectors

Connectique pneumatique

Condutture pneumatiche

TrΔle®





A HUNDRED HEADS. ONE MIND.

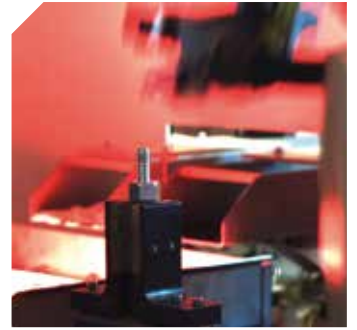
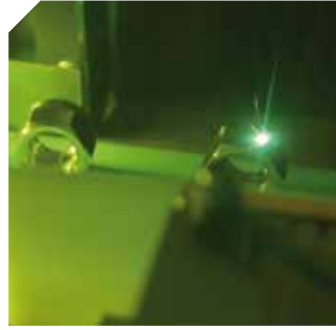

FABRICACIÓN • MANUFACTURE
 LOGÍSTICA • LOGISTICS
 ÁREA CALIDAD • QUALITY DEPARTMENT
 ÁREA TÉCNICA • TECHNICAL DEPARTMENT
 TALLER HIDRÁULICA • HYDRAULIC WORKSHOP
 TALLER LATIGUILLOS • HOSE ASSEMBLY WORKSHOP
 TALLER SOLDADURA • WELDING WORKSHOP
 SERVICIOS COMERCIALES • COMMERCIAL SERVICES
 PLATAFORMA DIGITAL • DIGITAL PLATFORM



Flexibles hidráulicos

Flexible connectors

Flexibles hydrauliques

Flessibili idrauliche

TrAle®



Mangueras

Hoses
Tuyaux
Tubi flessibili

1

Racores para tubería flexible

Flexible hose fittings
Embouts à sertir
Raccordi per tubi flessibili

2

Metrología

Flow measuring
Test du circuit hydraulique
Test per circuiti idraulici

3

Máquinas tratamiento tubo flexible

Equipment for flexible hoses
Machines pour le montage des flexibles
Macchine per l'assemblaggio di tubi flessibili

4

Mangueras

Hoses

Tuyaux

Tubi flessibili

Mangueras hidráulicas TrΔle GOLD

Hydraulic hoses TrΔle GOLD

Tuyaux hydrauliques TrΔle GOLD

Tubi idraulici TrΔle GOLD

14

Mangueras hidráulicas TrΔle

Hydraulic hoses TrΔle

Tuyaux hydrauliques TrΔle

Tubi idraulici TrΔle

18

Mangueras hidráulicas MW - GreenLine

Hydraulic hoses MW - GreenLine

Tuyaux hydrauliques MW - GreenLine

Tubi idraulici MW - GreenLine

22

Mangueras termoplásticas TrΔle

Thermoplastic hoses TrΔle

Tuyaux thermoplastiques TrΔle

Tubi termoplastici TrΔle

23

Mangueras PTFE TrΔle

PTFE hoses TrΔle

Tuyaux PTFE TrΔle

Tubi PTFE TrΔle

26

1



Mangueras/Hoses:

TrAle®

Mangueras/Hoses:
SEMPERIT 



CONEXIONES FABRICADAS POR FITTINGS MANUFACTURED BY

DICSA

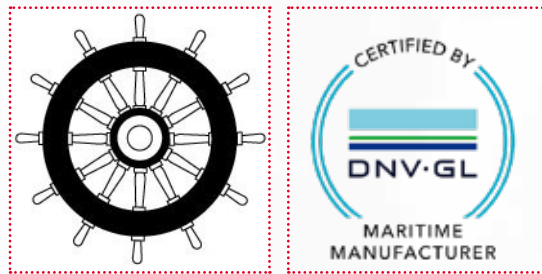

Mangueras hidráulicas TrΔle GOLD

Hydraulic hoses TrΔle GOLD

Tuyaux hydrauliques TrΔle GOLD

Tubi idraulici TrΔle GOLD

- Malla metálica TrΔle GOLD - RockCover / Steel Braid TrΔle GOLD - RockCover / Tresse métallique TrΔle GOLD - RockCover / Treccia metallica TrΔle GOLD - RockCover | 14



ML2230...RC

ML25C...RC

ML4290...RC

ML3511...RC

ML021...RC

ML4569...RC

- Malla metálica TrΔle GOLD - DiamondCover / Steel Braid TrΔle GOLD - DiamondCover / Tresse métallique TrΔle GOLD - DiamondCover / Treccia metallica TrΔle GOLD - DiamondCover | 15



ML3511...DC

ML4569..DC

- Malla metálica TrΔle GOLD - HighPressure / Steel Braid TrΔle GOLD - HighPressure / Tresse métallique TrΔle GOLD - HighPressure / Treccia metallica TrΔle GOLD - HighPressure | 16



MS1SNK

MS2SNK

- TrΔle GOLD - FlexyLine / TrΔle GOLD - FlexyLine / TrΔle GOLD - FlexyLine / TrΔle GOLD - FlexyLine | 16



FLEX6000

Mangueras hidráulicas TrΔle

Hydraulic hoses TrΔle
Tuyaux hydrauliques TrΔle
Tubi idraulici TrΔle

Flexible hose fittings

Flow measuring

Equipment for flexible hoses

■ Malla textil TrΔle / TrΔle Textile braid / Tresse textile TrΔle / Treccia tessile TrΔle

18



MSB21

ML7010

MB22

M2503

MB23

■ Malla metálica TrΔle / TrΔle steel braid / Tresse métallique TrΔle / Treccia metallica TrΔle

19



MS2230

MS3509

MS3511

M15C

M25C

ML3601

MS4290

M4612



MS4569

M4713

MS4815

■ Agua caliente TrΔle / TrΔle Hydrowashing hose for hot water / Tuyau lavage haute pression-TrΔle / Tubi per idropultrici ad acqua calda TrΔle

21



MSC011...N

MSC021...N

MSC011...A

MSC021...A

MSC022...A

MSC020...G

MSC1021...A

Mangueras hidráulicas MW - GreenLine

Hydraulic hoses MW - GreenLine

Tuyaux hydrauliques MW - GreenLine

Tubi idraulici MW - GreenLine

- Malla metálica MW - GreenLine / Steel braid MW - GreenLine / Tresse métallique MW - GreenLine / Treccia metallica MW - GreenLine | 22



MW2230



MW25C



MW4290



MW3511



MWC021...A



MW4569

Mangueras termoplásticas TrΔle

Thermoplastic hoses TrΔle

Tuyaux thermoplastiques TrΔle

Tubi termoplastici TrΔle

Flexible hose fittings

Flow measuring

Equipment for flexible hoses

■ Malla textil TrΔle / TrΔle textile braid / Tresse textile TrΔle / Treccia tessile TrΔle

23



■ Malla metálica TrΔle / TrΔle steel braid / Tresse métallique TrΔle / Treccia metallica TrΔle

24



■ Limpieza de alcantarillas TrΔle / Sewer jetting hose TrΔle / Tuyau hydrocurage TrΔle / Tubi per la pulizia di fognature

25



Mangueras PTFE TrΔle

PTFE hoses TrΔle
Tuyaux PTFE TrΔle
Tubi PTFE TrΔle

- PTFE liso /Smooth PTFE /PTFE lisse /PTFE liscio

26



M2950

M2900

M29012

- PTFE corrugado /Convolutated PTFE /PTFE convoluté /PTFE corrugato

26



M2920

M2980

M2930

- PTFE Liso PTFLEX /PTFLEX Smooth PTFE /PTFE Lisse PTFLEX /PTFE Liscio PTFLEX

27



M2940

Mangueras hidráulicas TrΔle GOLD

Hydraulic hoses TrΔle GOLD

Tuyaux hydrauliques TrΔle GOLD

Tubi idraulici TrΔle GOLD

Manguera TrΔle Gold EN 853 1SN - RockCover

EN 853 1SN hose TrΔle Gold - RockCover

Tuyau TrΔle Gold EN 853 1SN - RockCover

Tubi EN 853 1SN TrΔle Gold - RockCover



DN	Part nº Referencia	€
1/4"	ML223004RC	6,97
5/16"	ML223005RC	7,36
3/8"	ML223006RC	8,66
1/2"	ML223008RC	10,55
5/8"	ML223010RC	13,68
3/4"	ML223012RC	15,37
1"	ML223016RC	21,76
1"1/4	ML223020RC	30,94
1"1/2	ML223024RC	41,56
2"	ML223032RC	53,67

Manguera TrΔle Gold EN 853 2SN - RockCover

EN 853 2SN hose TrΔle Gold - RockCover

Tuyau TrΔle Gold EN 853 2SN - RockCover

Tubi EN 853 2SN TrΔle Gold - RockCover



DN	Part nº Referencia	€
1/4"	ML351104RC	9,45
5/16"	ML351105RC	10,16
3/8"	ML351106RC	11,01
1/2"	ML351108RC	12,70
5/8"	ML351110RC	17,39
3/4"	ML351112RC	20,13
1"	ML351116RC	29,57
1"1/4	ML351120RC	47,75
1"1/2	ML351124RC	57,06
2"	ML351132RC	72,56

Manguera TrΔle Gold EN 857 2SC - RockCover

EN 857 2SC hose TrΔle Gold - RockCover

Tuyau TrΔle Gold EN 857 2SC - RockCover

Tubi EN 857 2SC TrΔle Gold - RockCover



DN	Part nº Referencia	€
1/4"	ML25C04RC	8,88
3/8"	ML25C06RC	10,38
1/2"	ML25C08RC	12,44
5/8"	ML25C10RC	17,00
3/4"	ML25C12RC	18,88
1"	ML25C16RC	27,82

Superservicio agua caliente 2 mallas negra 400bar TrΔle Gold - RockCover

Hot water black superservice 2 braids 400bar TrΔle Gold - RockCover

Superservice eau chaude 2 tresses noir 400bar TrΔle Gold - RockCover

Superservice acqua calda 2 trecce, nero 400bar TrΔle Gold - RockCover



DN	Part nº Referencia	€
5/16"	MLC0215NRC	10,29
3/8"	MLC0216NRC	12,10

Manguera TrΔle Gold EN 856 4SH - RockCover

EN 856 4SH hose TrΔle Gold - RockCover

Tuyau TrΔle Gold EN 856 4SH - RockCover

Tubi EN 856 4SH TrΔle Gold - RockCover



DN	Part nº Referencia	€
3/4"	ML456912RC	41,56
1"	ML456916RC	50,35
1"1/4	ML456920RC	74,52
1"1/2	ML456924RC	93,73
2"	ML456932RC	134,31

Manguera TrΔle Gold EN 856 4SP - RockCover

EN 856 4SP hose TrΔle Gold - RockCover

Tuyau TrΔle Gold EN 856 4SP - RockCover

Tubi EN 856 4SP TrΔle Gold - RockCover



DN	Part nº Referencia	€
3/8"	ML429006RC	27,03
1/2"	ML429008RC	27,36
5/8"	ML429010RC	32,83
3/4"	ML429012RC	38,24
1"	ML429016RC	48,98

TrΔle[®] GOLD RockCover

RESISTENCIA EXTREMA

EXTREME RESISTANCE

Mangueras hidráulicas TrΔle GOLD

Hydraulic hoses TrΔle GOLD
Tuyaux hydrauliques TrΔle GOLD
Tubi idraulici TrΔle GOLD

Hoses

Flexible hose fittings

Flow measuring

Equipment for flexible hoses

Manguera TrΔle Gold EN 853 2SN - DiamondCover

EN 853 2SN hose TrΔle Gold - DiamondCover

Tuyau TrΔle Gold EN 853 2SN - DiamondCover

Tubi EN 853 2SN TrΔle Gold - DiamondCover



DN	Part nº Referencia	€
1/4"	ML351104DC	9,91
3/8"	ML351106DC	11,55
1/2"	ML351108DC	13,34

Manguera TrΔle Gold EN 856 4SH - DiamondCover

EN 856 4SH hose TrΔle Gold - DiamondCover

Tuyau TrΔle Gold EN 856 4SH - DiamondCover

Tubi EN 856 4SH TrΔle Gold - DiamondCover



DN	Part nº Referencia	€
3/4"	ML456912DC	43,63
1"	ML456916DC	52,89

RESISTENCIA A LA ABRASIÓN (ISO 6945)

ABRASION RESISTANCE

25N / 2000 cycles

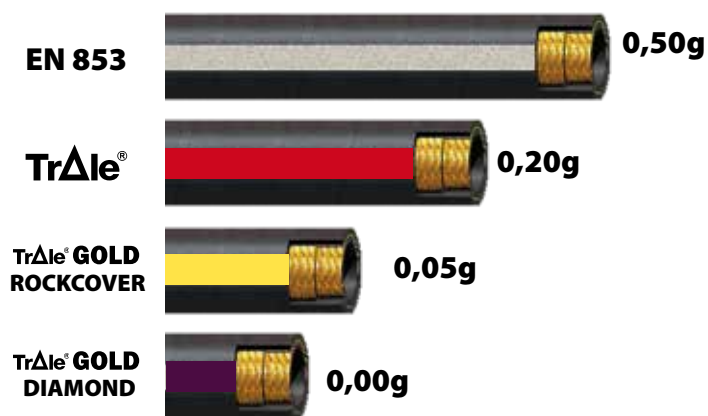

RESISTENCIA AL OZONO (ISO 7326)

OZONO RESISTANCE

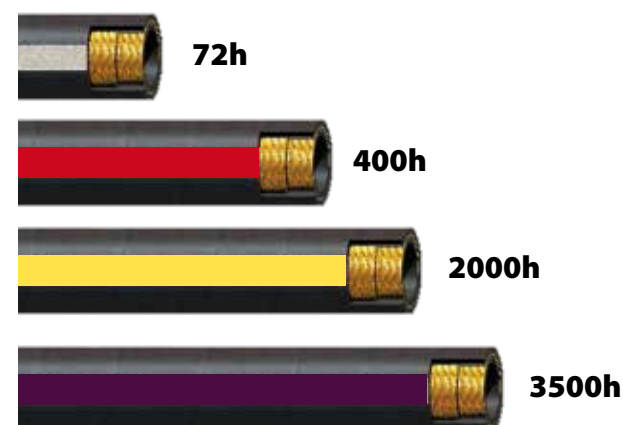

CUBIERTA UHMPE COVER

TODOS NUESTROS MODELOS DE ROCKCOVER EN
ALL OUR ROCKCOVER RANGE AVAILABLE WITH

DIAMOND COVER

Mangueras hidráulicas TrΔle GOLD

Hydraulic hoses TrΔle GOLD

Tuyaux hydrauliques TrΔle GOLD

Tubi idraulici TrΔle GOLD

Manguera TrΔle Gold EN857 1SNK - HighPressure

EN857 1SNK hose TrΔle Gold - HighPressure

Tuyau TrΔle Gold EN857 1SNK - HighPressure

Tubi EN857 1SNK TrΔle Gold - HighPressure



DN	Part n° Referencia	€
1/4"	MS1SNK04	*
5/16"	MS1SNK05	*
3/8"	MS1SNK06	*
1/2"	MS1SNK08	*
5/8"	MS1SNK10	*
3/4"	MS1SNK12	*
1"	MS1SNK16	*

Manguera TrΔle Gold EN857 2SNK - HighPressure

EN857 2SNK hose TrΔle Gold - HighPressure

Tuyau TrΔle Gold EN857 2SNK - HighPressure

Tubi EN857 2SNK TrΔle Gold - HighPressure



DN	Part n° Referencia	€
1/4"	MS2SNK04	9,51
5/16"	MS2SNK05	10,23
3/8"	MS2SNK06	11,01
1/2"	MS2SNK08	12,96
5/8"	MS2SNK10	17,72
3/4"	MS2SNK12	20,39
1"	MS2SNK16	30,03

FLEXLINE 6000

FLEXLINE 6000

FLEXLINE 6000

FLEXLINE 6000



DN	Part n° Referencia	€	
3/8"	6	MFLEX6006	*
1/2"	12	MFLEX6008	*
5/8"	16	MFLEX6010	*
3/4"	19	MFLEX6012	*
1"	25	MFLEX6016	*
1"1/4	32	MFLEX6020	*
1"1/2	38	MFLEX6024	*
2"	51	MFLEX6032	*

TrAde[®] GOLD

RockCover



RESISTENCIA ABRASIÓN
ABRASION RESISTANCE



ALTA FLEXIBILIDAD
HIGH FLEXIBILITY

FlexyLine



HighPressure



PRESIÓN +++
+++ PRESSURE



APLICACIONES FERROVIARIAS
RAILWAY

RailLine



Mangueras hidráulicas TrΔle

Hydraulic hoses TrΔle
Tuyaux hydrauliques TrΔle
Tubi idraulici TrΔle

Manguera EN 854 R6 / SAE 100 R6

EN 854 R6 / SAE 100 R6 Hose

Tuyau EN 854 R6 / SAE 100 R6

Tubi EN 854 R6 / SAE 100 R6



DN	Part nº Referencia	€
1/4"	MSB2104	4,34
5/16"	MSB2105	5,58
3/8"	MSB2106	6,33
1/2"	MSB2108	8,44
5/8"	MSB2110	10,07
3/4"	MSB2112	12,42
1"	MSB2116	16,72

Manguera SAE 100 R4

SAE 100 R4 Hose

Tuyau SAE 100 R4

Tubi SAE 100 R4



DN	Part nº Referencia	€
3/4"	ML701019	13,18
1"	ML701025	18,68
1"1/4	ML701032	23,96
1"1/2	ML701038	26,81
2"	ML701050	42,24
2"1/2	ML701063	46,71

Manguera EN 854 2TE

EN 854 2TE Hose

Tuyau EN 854 2TE

Tubi EN 854 2TE



DN	Part nº Referencia	€
1/4"	MB2204	6,22
5/16"	MB2205	7,47
3/8"	MB2206	8,01
1/2"	MB2208	9,34
5/8"	MB2210	11,20
3/4"	MB2212	13,25
1"	MB2216	17,34

Manguera SAE 100 R5

SAE 100 R5 Hose

Tuyau SAE 100 R5

Tubi SAE 100 R5



DN	Part nº Referencia	€
3/16"	M250304	4,87
1/4"	M250305	4,87
5/16"	M250306	6,39
13/32"	M250308	6,87
1/2"	M250310	8,85
5/8"	M250312	11,24
7/8"	M250316	22,65
1"1/8	M250320	27,38
1"3/8	M250324	27,75
1"13/16	M250332	31,57

Manguera EN 854 3TE

EN 854 3TE Hose

Tuyau EN 854 3TE

Tubi EN 854 3TE



DN	Part nº Referencia	€
1/4"	MB2304	7,15
5/16"	MB2305	7,47
3/8"	MB2306	7,96
1/2"	MB2308	9,10
5/8"	MB2310	11,05
3/4"	MB2312	13,00
1"	MB2316	17,06

Mangueras hidráulicas TrΔle

Hydraulic hoses TrΔle
Tuyaux hydrauliques TrΔle
Tubi idraulici TrΔle

Manguera EN 853 1SN / SAE 100 R1AT

EN 853 1SN / SAE 100 R1AT Hose

Tuyau EN 853 1SN / SAE 100 R1AT

Tubi EN 853 1SN / SAE 100 R1AT



DN	Part nº Referencia	€
3/16"	MS223003	4,91
1/4"	MS223004	4,79
5/16"	MS223005	6,29
3/8"	MS223006	6,77
1/2"	MS223008	8,07
5/8"	MS223010	10,25
3/4"	MS223012	12,61
1"	MS223016	17,66
1"1/4"	MS223020	23,96
1"1/2"	MS223024	27,32
2"	MS223032	35,32

Manguera EN 853 2ST / SAE 100 R2A

EN 853 2ST / SAE 100 R2A Hose

Tuyau EN 853 2ST / SAE 100 R2A

Tubi EN 853 2ST / SAE 100 R2A



DN	Part nº Referencia	€
1/4"	MS350904	6,60
5/16"	MS350905	8,67
3/8"	MS350906	9,66
1/2"	MS350908	12,20
5/8"	MS350910	15,16
3/4"	MS350912	17,65
1"	MS350916	24,20
1" 1/4"	MS350920	31,58
1" 1/2"	MS350924	37,33
2"	MS350932	50,25

Manguera EN 853 2SN / SAE 100 R2AT

EN 853 2SN / SAE 100 R2AT Hose

Tuyau EN 853 2SN / SAE 100 R2AT

Tubi EN 853 2SN / SAE 100 R2AT



DN	Part nº Referencia	€
3/16"	MS351103	7,32
1/4"	MS351104	6,49
5/16"	MS351105	8,08
3/8"	MS351106	8,53
1/2"	MS351108	10,24
5/8"	MS351110	12,96
3/4"	MS351112	15,46
1"	MS351116	22,96
1"1/4"	MS351120	30,52
1"1/2"	MS351124	35,70
2"	MS351132	43,02
2" 1/2"	MS351140	54,01
3"	MS351148	64,55

Manguera EN 857 1SC

EN 857 1SC Hose

Tuyau EN 857 1SC

Tubi 1SC/EN857



DN	Part nº Referencia	€
1/4"	M1SC04	5,58
5/16"	M1SC05	6,32
3/8"	M1SC06	7,06
1/2"	M1SC08	8,54
5/8"	M1SC10	9,99
3/4"	M1SC12	12,15
1"	M1SC16	15,95

Manguera EN 857 2SC

EN 857 2SC Hose

Tuyau EN 857 2SC

Tubi 2SC/EN857



DN	Part nº Referencia	€
1/4"	M2SC04	6,88
5/16"	M2SC05	7,65
3/8"	M2SC06	8,40
1/2"	M2SC08	9,77
5/8"	M2SC10	12,89
3/4"	M2SC12	14,47
1"	M2SC16	20,32

Manguera hidráulica 3SP

3SP Braids hoses

Tuyau 3SP

Tubi 3SP trecce



DN	Part nº Referencia	€
3/8"	MS36010600	15,66
1/2"	MS36010800	20,99
5/8"	MS36011000	24,63
3/4"	MS36011200	30,66
1"	MS36011600	42,24

Mangueras hidráulicas TrΔle

Hydraulic hoses TrΔle
Tuyaux hydrauliques TrΔle
Tubi idraulici TrΔle

Manguera EN 856 4SP / SAE 100 R9R-R10

EN 856 4SP / SAE 100 R9R-R10 Hose

Tuyau EN 856 4SP / SAE 100 R9R-R10

Tubi EN 856 4SP / SAE 100 R9R-R10



DN	Part nº Referencia	€
1/4"	MS429004	19,84
3/8"	MS429006	22,22
1/2"	MS429008	24,61
5/8"	MS429010	29,18
3/4"	MS429012	30,47
1"	MS429016	38,85
1"1/4	MS424820	58,44
1"1/2	MS424824	70,38
2"	MS424832	81,79

Manguera EN 856 R12 / SAE 100 R12

EN 856 R12 / SAE 100 R12 Hose

Tuyau EN 856 R12 / SAE 100 R12

Tubi EN 856 R12 / SAE 100 R12



DN	Part nº Referencia	€
3/8"	M461206	26,37
1/2"	M461208	24,46
5/8"	M461210	28,27
3/4"	M461212	32,74
1"	M461216	43,73
1"1/4	M461220	57,08
1"1/2	M461224	68,49

Manguera EN 856 4SH

EN 856 4SH Hose

Tuyau EN 856 4SH

Tubi EN 856 4SH



DN	Part nº Referencia	€
3/4"	MS456912	33,45
1"	MS456916	44,38
1"1/4	MS456920	63,89
1"1/2	MS456924	76,95
2"	MS456932	89,42

Manguera EN 856 R13 / SAE 100 R13

EN 856 R13 / SAE 100 R13 Hose

Tuyau EN 856 R13 / SAE 100 R13

Tubi EN 856 R13 / SAE 100 R13



DN	Part nº Referencia	€
3/4"	M471312	40,13
1"	M471316	52,82
1"1/4	M471320	81,80
1"1/2	M471324	97,61
2"	M471332	138,52

Manguera SAE 100 R15

SAE 100 R15 Hose

Tuyau SAE 100 R15

Tubi SAE 100 R15



DN	Part nº Referencia	€
1"	MS481516	46,60
1"1/4	MS481520	96,46
1"1/2	MS481524	111,90
2"	MS481532	184,24

Mangueras hidráulicas TrΔle

Hydraulic hoses TrΔle
Tuyaux hydrauliques TrΔle
Tubi idraulici TrΔle

Superservicio agua caliente 1SC negra

Hot water superservice 1SC black

Superservice eau chaude 1SC noir

Superservice acqua calda 1SC nero



DN	Part n° Referencia	€
1/4"	MSC0114N	5,77
5/16"	MSC0115N	6,86
3/8"	MSC0116N	7,68
1/2"	MSC0118N	9,85

Superservicio agua caliente 2SC negra

Hot water superservice 2SC black

Superservice eau chaude 2SC noir

Superservice acqua calda 2SC nero



DN	Part n° Referencia	€
1/4"	MSC0214N	6,22
5/16"	MSC0215N	8,06
3/8"	MSC0216N	9,21
1/2"	MSC0218N	11,76

Superservicio agua caliente 1SC azul

Hot water superservice 1SC blue

Superservice eau chaude 1SC bleu

Superservice acqua calda 1SC azzurro



DN	Part n° Referencia	€
1/4"	MSC0114A	5,61
5/16"	MSC0115A	6,70
3/8"	MSC0116A	7,50
1/2"	MSC0118A	9,62

Superservicio agua caliente 2SC azul

Hot water superservice 2SC blue

Superservice eau chaude 2SC bleu

Superservice acqua calda 2SC azzurro



DN	Part n° Referencia	€
1/4"	MSC0214A	6,78
5/16"	MSC0215A	9,28
3/8"	MSC0216A	10,47
1/2"	MSC0218A	13,28

Superservicio agua caliente 2ST azul

Hot water superservice 2ST blue

Superservice eau chaude 2ST bleu

Superservice acqua calda 2ST azzurro



DN	Part n° Referencia	€
5/16"	MSC0225A	9,28
3/8"	MSC0226A	10,36

Superservicio agua caliente 2SC gris

Hot water superservice 2SC grey

Superservice eau chaude 2SC gris

Superservice acqua calda 2SC grigio



DN	Part n° Referencia	€
5/16"	MSC0205G	9,04
3/8"	MSC0206G	10,40

Superservicio agua caliente 2SC azul LISA

Hot water superservice 2SC blue with SMOOTH surface

Superservice eau chaude 2SC bleu à surface LISSE

Superservice acqua calda 2SC Azzurro con superficie LISCIA



DN	Part n° Referencia	€
5/16"	MSCL0215A	8,72
3/8"	MSCL0216A	9,69

MSCL021...

Superservicio agua caliente 2SC azul LISA
Hot water superservice 2SC blue with SMOOTH surface

CUBIERTA LISA
Más fácil de limpiar

SMOOTH SURFACE
Easy-to-clean design

Mangueras hidráulicas MW - GreenLine

Hydraulic hoses MW - GreenLine

Tuyaux hydrauliques MW - GreenLine

Tubi idraulici MW - GreenLine

Manguera EN 853 1SN / SAE 100 R1AT

EN 853 1SN / SAE 100 R1AT Hose

Tuyau EN 853 1SN / SAE 100 R1AT

Tubi EN 853 1SN / SAE 100 R1AT



DN	Part nº Referencia	€
1/4"	MW223004	4,63
5/16"	MW223005	5,72
3/8"	MW223006	6,35
1/2"	MW223008	7,44
5/8"	MW223010	8,88
3/4"	MW223012	10,95
1"	MW223016	15,47
1"1/4	MW223020	22,62

Manguera EN 857 2SC

EN 857 2SC Hose

Tuyau EN 857 2SC

Tubi 2SC/EN857



DN	Part nº Referencia	€
1/4"	MW25C04	6,06
5/16"	MW25C05	7,34
3/8"	MW25C06	8,16
1/2"	MW25C08	9,48

Manguera EN 856 4SP / SAE 100 R9R-R10

EN 856 4SP / SAE 100 R9R-R10 Hose

Tuyau EN 856 4SP / SAE 100 R9R-R10

Tubi EN 856 4SP / SAE 100 R9R-R10



DN	Part nº Referencia	€
3/8"	MW429006	20,16
1/2"	MW429008	22,19
5/8"	MW429010	26,77

Manguera EN 853 2SN / SAE 100 R2AT

EN 853 2SN / SAE 100 R2AT Hose

Tuyau EN 853 2SN / SAE 100 R2AT

Tubi EN 853 2SN / SAE 100 R2AT



DN	Part nº Referencia	€
1/4"	MW351104	6,06
5/16"	MW351105	7,34
3/8"	MW351106	8,16
1/2"	MW351108	9,48
5/8"	MW351110	11,42
3/4"	MW351112	14,43
1"	MW351116	19,40
1"1/4	MW351120	28,57
1"1/2	MW351124	33,55

Superservicio agua caliente 2SC azul

Hot water superservice 2SC blue

Superservice eau chaude 2SC bleu

Superservice acqua calda 2SC azzurro



DN	Part nº Referencia	€
5/16"	MWC0215A	7,18
3/8"	MWC0216A	7,98

Manguera EN 856 4SH

EN 856 4SH Hose

Tuyau EN 856 4SH

Tubi EN 856 4SH



DN	Part nº Referencia	€
3/4"	MW456912	30,48
1"	MW456916	38,95
1"1/4	MW456920	51,91

Mangueras termoplásticas TrΔle

Thermoplastic hoses TrΔle

Tuyaux thermoplastiques TrΔle

Tubi termoplastici TrΔle

SAE 100 R7

SAE 100 R7

SAE 100 R7

SAE 100 R7



DN	Part nº Referencia	€
1/8"	MT07002	4,57
3/16"	MT07003	5,02
1/4"	MT07004	6,11
5/16"	MT07005	8,69
3/8"	MT07006	9,33
1/2"	MT07008	13,51
5/8"	MT07010	19,88
3/4"	MT07012	22,46
1"	MT07016	33,78

SAE 100 R8

SAE 100 R8

SAE 100 R8

SAE 100 R8



DN	Part nº Referencia	€
3/16"	MT08003	9,97
1/4"	MT08004	16,67
5/16"	MT08005	18,28
3/8"	MT08006	23,94
1/2"	MT08008	31,72
5/8"	MT08010	41,12
3/4"	MT08012	52,70
1"	MT08016	75,68

SAE 100 R7 no conductiva

SAE 100 R7 non-conductive

SAE 100 R7 non-conducteur

SAE 100 R7 non conduttivo



DN	Part nº Referencia	€
3/16"	MT07103	5,15
1/4"	MT07104	6,31
5/16"	MT07105	8,88
3/8"	MT07106	9,72
1/2"	MT07108	13,96
5/8"	MT07110	20,53
3/4"	MT07112	23,10
1"	MT07116	34,81

Micro- Hose

Micro- Hose

Micro- Hose

Micro- Tubo



Ø INNER Ø INT.	Part nº Referencia	€
2	MT01002	3,43

SAE 100 R7 Bitubo

SAE 100 R7 Twin

SAE 100 R7 Jumelé

SAE 100 R7 Binato



DN	Part nº Referencia	€
3/16"	MT27003	11,58
1/4"	MT27004	13,84
5/16"	MT27005	18,92
3/8"	MT27006	20,21
1/2"	MT27008	28,51

SAE 100 R8 Bitubo

SAE 100 R8 Twin

SAE 100 R8 Jumelé

SAE 100 R8 Binato



DN	Part nº Referencia	€
1/4"	MT28004	34,94
5/16"	MT28005	38,16
3/8"	MT28006	49,55
1/2"	MT28008	65,06

SAE 100 R8 no conductiva

SAE 100 R8 non-conductive

SAE 100 R8 non-conducteur

SAE 100 R8 non conduttivo



DN	Part nº Referencia	€
1/4"	MT08104	17,12
5/16"	MT08105	18,85
3/8"	MT08106	24,65
1/2"	MT08108	32,69
5/8"	MT08110	42,41
3/4"	MT08112	54,25
1"	MT08116	77,99

Termoplásticas Push-on

Thermoplastic Push-on

Thermoplastique Push-on

Tubi termoplastici Push-on



DN	Part nº Referencia	€
1/4"	MP189004	6,84
3/8"	MP189006	9,25
1/2"	MP189008	15,02
5/8"	MP189010	20,12
3/4"	MP189012	24,34

Mangueras termoplásticas TrΔle

Thermoplastic hoses TrΔle

Tuyaux thermoplastiques TrΔle

Tubi termoplastici TrΔle

Elastómero malla metálica

Steel braid thermoplastic elastomer

Elastomère 1 tresse métallique

Treccia metallica



DN	Part nº Referencia	€
3/16"	MT09003	7,53
1/4"	MT09004	8,62
5/16"	MT09005	9,78
3/8"	MT09006	11,20
1/2"	MT09008	14,22
5/8"	MT09010	18,85
3/4"	MT09012	21,24
1"	MT09016	29,92

Elastómero malla metálica pintura

Steel braid thermoplastic elastomer for paint

Elastomère 1 tresse métallique peinture

Treccia metallica per vernici



DN	Part nº Referencia	€
3/16"	MT099003	7,72
1/4"	MT099004	8,88
3/8"	MT099006	11,58
1/2"	MT099008	14,67
3/4"	MT099012	21,88

Isobárica baja temperatura

Isobaric low temperature

Isobarique basse température

Isobarica bassa temperatura



DN	Part nº Referencia	€
1/4"	MT095004	14,61
3/8"	MT095006	31,08
1/2"	MT095008	41,12

Elastómero malla metálica bitubo

Steel braid twin thermoplastic elastomer

Elastomère 1 tresse métallique jumelé

Treccia metallica Binato



DN	Part nº Referencia	€
3/16"	MT29003	16,54
1/4"	MT29004	18,79
5/16"	MT29005	21,04
3/8"	MT29006	23,94
1/2"	MT29008	29,92

Elastómero doble malla metálica pintura

Double steel braid thermoplastic elastomer for paint

Elastomère 2 tresses métalliques peinture

Doppia treccia metallica per vernici



DN	Part nº Referencia	€
1/4"	MT299004	14,87
3/8"	MT299006	21,69
1/2"	MT299008	25,03

Manguera termoplástica 700 bar

Thermoplastic hose 700 bar

Tuyau thermoplastique haute pression 700 bar

Tubo termoplastico 700 bar



DN	Part nº Referencia	€
1/4"	MT70004	23,10
3/8"	MT70006	54,44

Termoplástica malla metálica para productos químicos

Steel braid elastomer for chemical products

Elastomère tresse métallique pour produits chimiques

Treccia metallica per sostanze chimiche



DN	Part nº Referencia	€
1/4"	MT096004	16,28
3/8"	MT096006	23,81
1/2"	MT096008	27,54
5/8"	MT096010	39,32
3/4"	MT096012	44,59
1"	MT096016	57,98

Mangueras termoplásticas TrΔle

Thermoplastic hoses TrΔle

Tuyaux thermoplastiques TrΔle

Tubi termoplastici TrΔle

Ecology 200

Ecology 200

Ecology 200

Ecology 200



DN	Part nº Referencia	€
5/8"	MEC20010	23,10
3/4"	MEC20012	25,10
1"	MEC20016	42,47
1" 1/4	MEC20020	54,06

Ecology 250

Ecology 250

Ecology 250

Ecology 250



DN	Part nº Referencia	€
3/4"	MEC25012	38,45
1"	MEC25016	58,00

Casquillos para manguera Ecology

Ferrules for Ecology hose

Jupes pour tuyau Ecology

Boccole pressare per tubi Ecologici

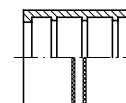

DN	Part nº Referencia	€
3/4"	Z212001200	*
1"	Z212001600	*
1"1/4	Z212002000	*

Acero inoxidable AISI 316-L. Ver precios en Catalogo Inox p.22 / Stainless steel AISI 316-L.
Prices in Stainless Steel Catalogue p.22 / Acier inoxydable AISI 316-L. Prix dans le Catalogue Acier
Inox p.22 / Acciaio inossidabile AISI 316-L. Prezzi in Acciaio Inossidabile p.22

Mangueras PTFE TrΔle

PTFE hoses TrΔle
Tuyaux PTFE TrΔle
Tubi PTFE TrΔle

PTFE sin malla

PTFE without braid

PTFE sans tresse

PTFE senza treccia



PIPE TUBO	LENGTH (M) LONGITUD (M)	Part n° Referencia	€
2x4	25	M2950204	85,73
4x6	25	M2950406	125,94
6x8	25	M2950608	182,17
2x4	100	M2950204-100	342,92
4x6	100	M2950406-100	503,66
6x8	100	M2950608-100	728,70

€/ rollo / €/ roll / €/rouleau / €/rotolo

PTFE Liso 1 malla SAE100 R14

FHL (light) / Smooth PTFE SAE100 R14

FHL (série légère) SAE100 R14

FHL (serie leggera) SAE 100 R14



DN	Part n° Referencia	€
1/8"	M290003	11,03
3/16"	M290005	11,79
1/4"	M290006	11,72
5/16"	M290008	15,74
3/8"	M290009	15,74
1/2"	M290013	21,57
5/8"	M290016	31,27
3/4"	M290020	38,83
1"	M290025	62,75

PTFE Liso grueso 2 mallas

FHM 2 Braids

FHM 2 tresses

FHM doppia treccia



DN	Part n° Referencia	€
1/4"	M2901206	21,36
5/16"	M2901208	25,31
3/8"	M2901209	28,98
1/2"	M2901213	39,32
5/8"	M2901216	53,53
3/4"	M2901219	62,82
1"	M2901225	85,70

PTFE corrugado 1 malla

Convuluted PTFE 1 braid

PTFE convoluté 1 tresse

PTFE corrugato 1 maglia



DN	Ø Inner Min. Ø INT. MIN.	Ø Inner Max. Ø INT. MAX.	Ø Out Min Ø EXT. MIN.	Ø OUT MAX Ø EXT. MÁX.	Part n° Referencia	€
1/4"	5,95	6,45	9,14	9,65	M292006	28,11
3/8"	10	11	14,7	16,2	M292009	36,26
1/2"	13	14	18	19,7	M292013	39,14
5/8"	16	17	21,5	23	M292016	48,19
3/4"	19,5	20,7	25	27,5	M292020	56,37
1"	25,4	26,8	32	34,3	M292025	80,02
1" 1/4	31,5	33	38,5	41	M292032	128,56
1" 1/2	38	40	44,5	48	M292038	163,62
2"	50,5	52,7	57	62	M292050	214,97

PTFE corrugado con fibra de vidrio 1 malla

Convuluted PTFE with fiberglass 1 braid

PTFE convoluté avec fibre de verre 1 tresse

PTFE con fibra di vetro 1 maglia



DN	Part n° Referencia	€
3/8"	M298009	71,99
1/2"	M298013	96,49
3/4"	M298020	127,31
1"	M298025	169,55
1" 1/4	M298032	200,98

PTFE corrugado anti-estático 1 malla

Anti-static convuluted PTFE 1 braid

PTFE convoluté anti-statique 1 tresse

PTFE corrugato anti-statico 1 maglia



DN	Ø Inner Min. Ø INT. MIN.	Ø Inner Max. Ø INT. MAX.	Ø Out Min Ø EXT. MIN.	Ø OUT MAX Ø EXT. MÁX.	Part n° Referencia	€
3/8"	10	11	14,7	16,2	M293009	50,20
1/2"	13	14	18	19,7	M293013	56,73
3/4"	19,5	20,7	25	27,5	M293020	77,38
1"	25,4	26,8	32	34,3	M293025	103,35

Mangueras PTFE TrΔle

PTFE hoses TrΔle
Tuyaux PTFE TrΔle
Tubi PTFE TrΔle

PTFE Liso PTFLEX

PTFLEX Smooth PTFE

PTFE Lisse PTFLEX

PTFE Liscio PTFLEX



DN	Part nº Referencia	€
3/4"	M294020	*
1"	M294025	*
1"1/4	M294032	*

PTFLEX Lo mejor del PTFE corrugado y liso
The best of convoluted & smoothbore hose

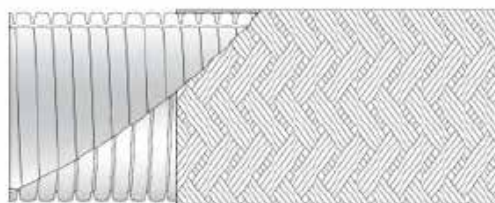

Diseño híbrido entre manguera corrugada y lisa, del cual se obtienen las ventajas y beneficios de ambas: **Flexibilidad**, el **flujo continuo** y la **facilidad de limpieza interior**, todo en una manguera de PTFE.

* Opción antiestática bajo consulta.

As a hybrid of both traditional Convoluted & Smoothbore hose designs you gain the advantages and benefits of **flexibility**, **flow rates** and **cleanability** all in one PTFE hose.

* Antistatic option on request

SISTEMAS DE FRENADO MOTORCYCLE BRAKING SYSTEMS

Consultar | On request

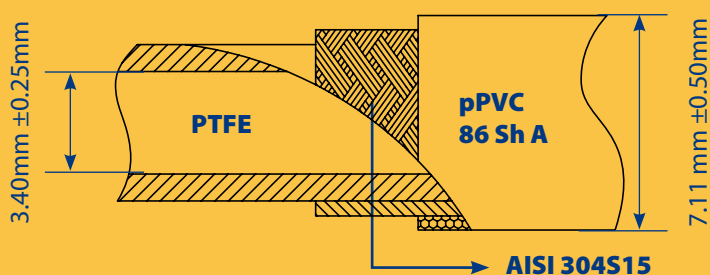

321 BAR



966 BAR



38mm



-10° to
+70°C*

*Limitado por la cubierta de PVC | Limited by PVC Cover



Racores para tubería flexible

Flexible hose fittings

Embouts à sertir

Raccordi per tubi flessibili

Conexiones Serie Standard

Standard series fittings
Embouts série Standard
Raccordi serie Standard

42

Conexiones Serie Reusables

Reusable series fittings
Embouts Récuperables
Raccordi serie Recuperabile

60

Conexiones Serie BW no pelar R12 / 4SP / 4SH

BW fittings - no skiving R12 / 4SP / 4SH
Embouts BW sans dénuder R12 / 4SP / 4SH
Raccordi BW - senza pelatura R12 / 4SP / 4SH

61

Conexiones Serie Interlock

Interlock series fittings
Embouts à sertir Interlock
Raccordi serie Interlock

64

Conexiones Alta presión (700 Bar)

High pressure 700 Bar fittings
Embouts haute pression 700 Bar
Raccordi altissima pressione (700 Bar)

70

Conexiones Serie 43 una sola pieza 1SN / 2SN / R16 / 2SC / 3TE / R17

One piece fittings 43 Series 1SN / 2SN / R16 / 2SC / 3TE / R17
Embouts pré-sertis Série 43 1SN / 2SN / R16 / 2SC / 3TE / R17
Raccordi un pezzo Serie 43 1SN / 2SN / R16 / 2SC / 3TE / R17

72

Conexiones Serie BW una sola pieza R12 / 4SP / 4SH

One piece fittings BW series R12 / 4SP / 4SH
Embouts pré-sertis Série BW R12 / 4SP / 4SH
Raccordi BW - 1 pezzo R12 / 4SP / 4SH

86

2

Tablas de Prensados | Crimping Charts

¿CÓMO SE DESCARGAN DE NUESTRA WEB? HOW TO DOWNLOAD FROM OUR WEBSITE?

1 Haz click en **Tablas de Prensado** al pasar por el menú **Descargas**
Go to **Download** and click on the **Crimping Charts**

2 Y **descarga** la que necesites haciendo click en su nombre
And **download** the one you need by clicking on its name

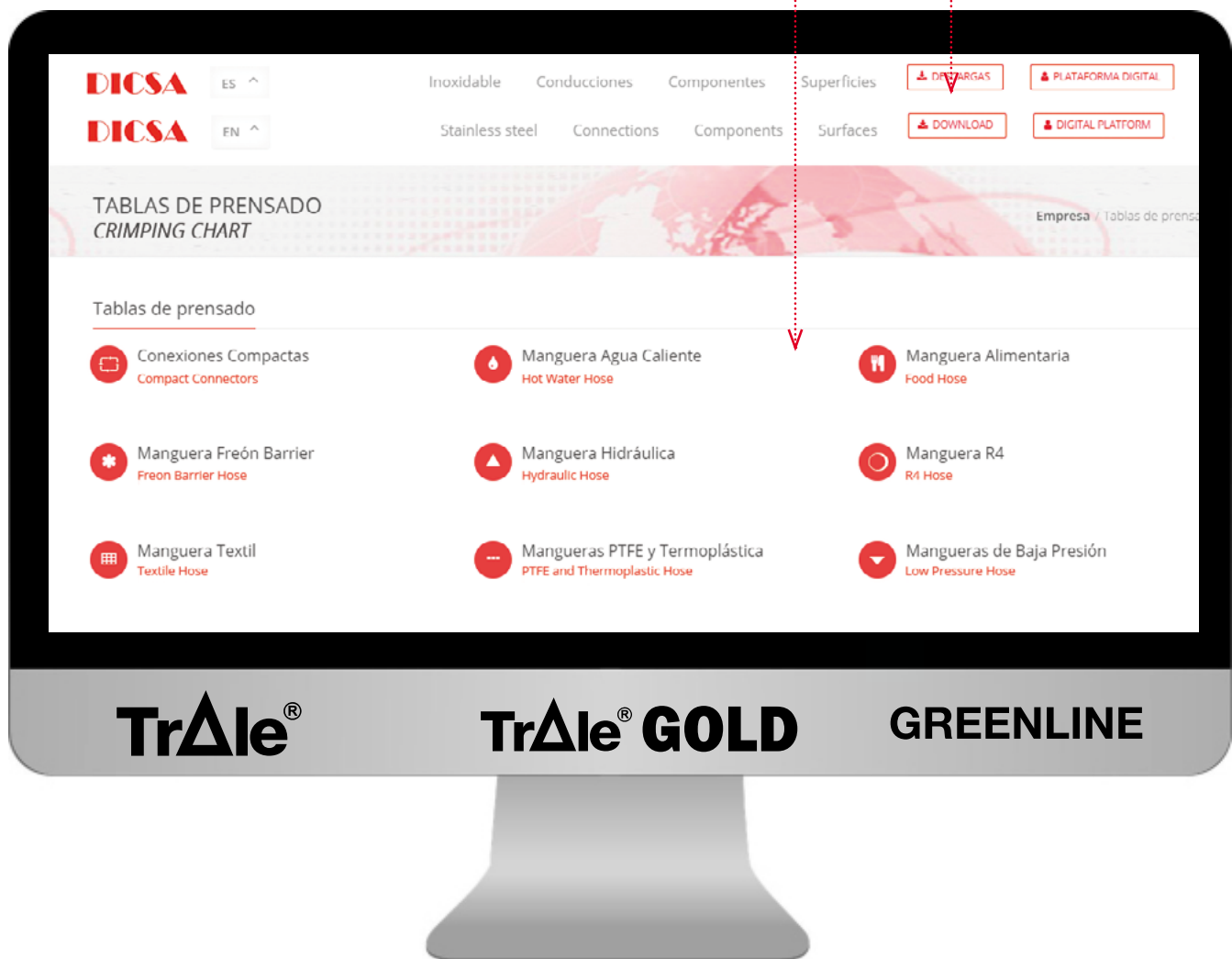

Datos de tablas de prensados siempre actualizados en nuestra web
Crimping Charts information always updated on our website

www.dicsaes.com

TrAle®

TrAle® GOLD

GREENLINE

■ Una única conexión para una amplia gama de mangueras

One only fitting for a big hose range

Un seul raccord pour une grande gamme de tuyaux

Un solo raccordo per una vasta gamma di tubi

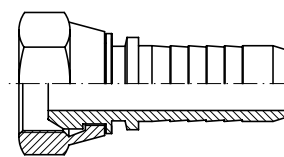

SAE 100 R6	EN 854 2TE	EN 854 3TE	EN 857 1SC SUPERSERVICE 15C 155°	EN 853 15N SAE 100 R1AT 15NK	EN 853 25N SAE 100 R2AT 25NK	EN 857 25C SUPERSERVICE 25C 155°
DI23	DI23	DI2212	SC2112...	SC2112 DI2212	DI2212	DI2212

SAE 100 R7 EN 855 No conductiva	SAE 100 R8 EN 855 No conductiva	Metallic braid elastomer solvent	Metallic 2 braid elastomer solvent	Smooth PTFE 1 braid	Smooth PTFE 2 braid	Convoluted PTFE Std. Fiberglass Antistatic
DI23	DI23	DI23	DI1224	21040	21045	21041

EN 853 2ST SAE100 R2A	EN 856 4SP SAE 100 R9R	EN 856 R12 SAE 100	3SP EN856 4SP - 4SH - R12 SAE 100 R9R	Ecology 200	Ecology 250
DI1224	DI1224	DI1224	DI2224	Z2120...	Z2120...

Serie Interlock

Interlock serie
Série Interlock
Serie Interlock

TrAie®

TrAie® GOLD

GREENLINE

■ Una única conexión para toda la gama de mangueras de alta presión

One only fitting for all very high pressure hoses

Un seul raccord pour tous les tubes de très haute pression

Un solo raccordo per tutti i tubi ad altissima pressione

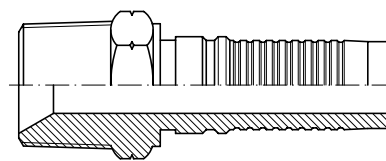

EN 856
4SH

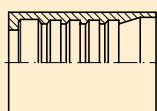

A61010



EN 856
R13
SAE 100

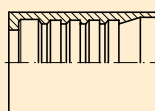

A61010
61010



SAE 100
R15

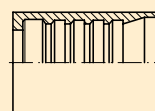

A61010
61010

Serie BW no pelar

BW Series no skiving

Série BW sans dénuder

Serie BW senza spellatura

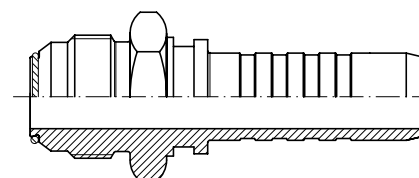

EN 856
4SP
SAE 100

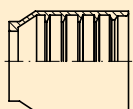

AC68010



EN 856
4SH

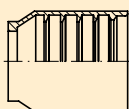

AC68010



EN 856
R12
SAE 100

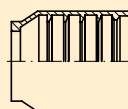

AC68010

Conexiones Serie Standard

Standard series fittings
 Embouts série Standard
 Raccordi serie Standard

■ Casquillos para prensar / Crimping ferrules / Jupes à sertir / Boccole a pressare

42

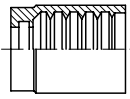

DI2212

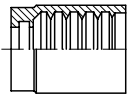

DI2212...R4

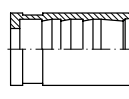

DI2300

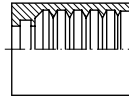

SC2112

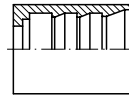

DI1224

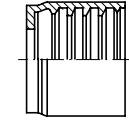

DI22240

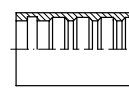

21040

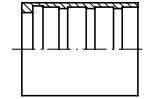

21045

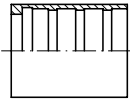

21041

■ Conexiones BSP/BSPT / BSP/BSPT Fittings / Embouts BSP/BSPT / Raccordi BSP/BSPT

44

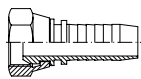

24100

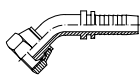

24108

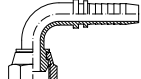

24107

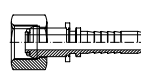

24110...L

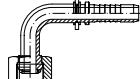

24117...L

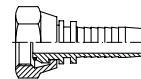

24110

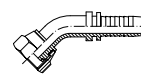

24118

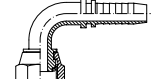

24117



24400

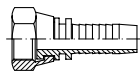

24200

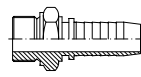

24212

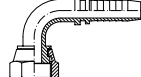

24207

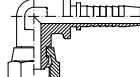

24127

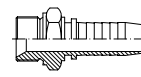

24112

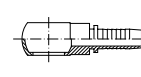

24111

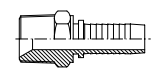

24114

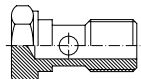

A1090

■ Conexiones JIC 37° / JIC 37° Fittings / Embouts JIC 37° / Raccordi JIC 37°

48

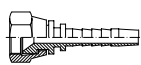

24142



24242



24138

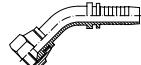

24139



24140



24300



24190

■ Conexiones Métricas DIN 2353 / Metric fittings DIN 2353 / Embouts Métriques DIN 2353 / Raccordi Metrici DIN 2353

50

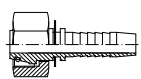

24804

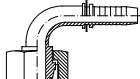

24305

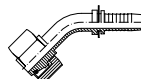

24306

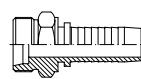

24203

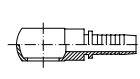

24116

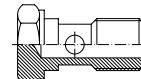

S1092

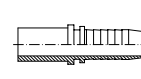

24158

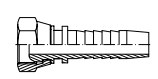

24404

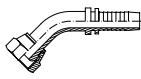

24406

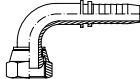

24405

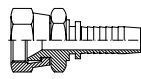

2580496

Conexiones Serie Standard

Standard series fittings
 Embouts série Standard
 Raccordi serie Standard

■ Conexiones NPT/NPSM / NPT/NPSM Fittings / Embouts NPT/NPSM / Raccordi NPT/NPSM | 54

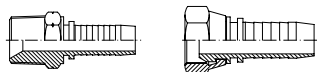

24161 24261

■ Conexiones Métricas Serie Francesa / Metric fittings French Serie / Embouts Métriques Série Française / Raccordi Metrici Serie Francese | 54

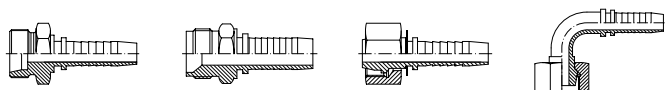

24503 2450518 24504 24505

■ Conexiones ORFS / ORFS Fittings / Embouts ORFS / Raccordi ORFS | 55



44900 44912 JUNTAS 44907 44908

■ Bridas SAE 3000/6000/9000 PSI / 3000/6000 PSI SAE Flanges / Brides SAE 3000/6000 PSI / Flangia SAE 3000/6000 PSI | 56

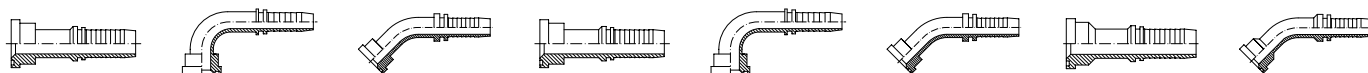

24182 24183 24184 24282 24283 24284 44282 44284

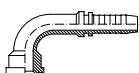

44283

■ Bridas fijación SAE / SAE Flanges / Brides SAE / Flangia SAE | 58



BBP BBE TBSAE JBR JUNTAS

■ Racores para hidrolavadoras / Karcher fittings / Embouts Karcher / Raccordi per idropultrici | 59



23040 2307 23060 23061 23062

■ Conexiones CO2 / CO2 Fittings / Embouts CO2 / Raccordi CO2 | 59

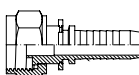

24704

Conexiones Serie Reusables

Reusable series fittings
 Embouts Récuperables
 Raccordi serie Recuperabile

■ Casquillos / Ferrules / Jupes / Boccole recuperabili

60

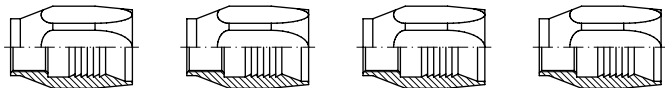

A1G...R1

A1G...R1T

A1G...R2

A1G...R2T

■ Conexiones / Fittings / Embouts / Raccordi recuperabili

60

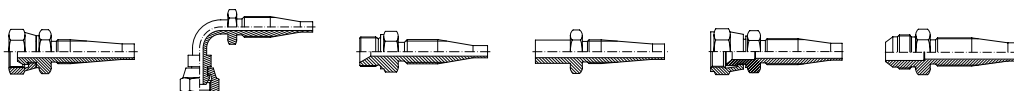

A3G

A90G

A2G

AE

A3J

A2J

Conexiones Serie BW no pelar R12 / 4SP / 4SH

BW fittings - no skiving R12 / 4SP / 4SH

Embouts BW sans dénuder R12 / 4SP / 4SH

Raccordi BW - senza pelatura R12 / 4SP / 4SH

- Casquillos R12/ 4SP/ 4SH serie BW / Ferrules R12/4SP/4SH BW series / Jupes à sertir R12/4SP/4SH série BW / Boccole pressare R12/4SP/4SH serie BW | 61

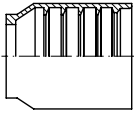

AC68010

- Conexiones BSP / BSP Fittings / Embouts BSP / Raccordi BSP | 61



66110

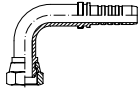

66117

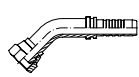

66118



66112

- Conexiones JIC 37° / JIC 37° Fittings / Embouts JIC 37° / Raccordi JIC 37° | 61

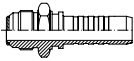

66140



66242

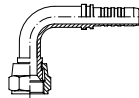

66138



66139

- Conexiones Métricas DIN 2353 / Metric fittings / Embouts Métriques / Raccordi Metrici | 62

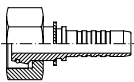

66204

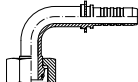

66205

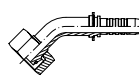

66206

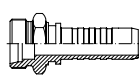

66203

- Bridas SAE 3000/6000 PSI / SAE Flanges 3000/6000 PSI / Brides SAE 3000/6000 PSI / Flangia SAE 3000/6000 PSI | 62



66182



66183

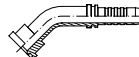

66184



66282



66283

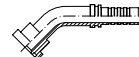

66284

- Conexiones ORFS / ORFS Fittings / Embouts ORFS / Raccordi ORFS | 63



66901



66907

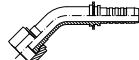

66908

Conexiones Serie Interlock

Interlock series fittings
 Embouts à sertir Interlock
 Raccordi serie Interlock

■ Casquillos / Crimping ferrules / Jupes / Boccole a pressare

64

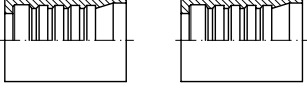

A61010

61010

■ Conexiones BSP / BSP Fittings / Embouts BSP / Raccordi BSP

64

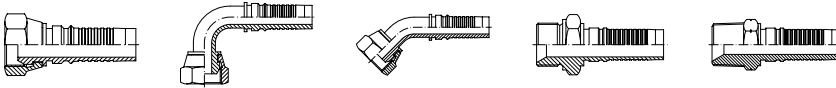

64100

64107

64108

64112

64161

■ Conexiones JIC 37° / JIC 37° Fittings / Embouts JIC 37° / Raccordi JIC 37°

65

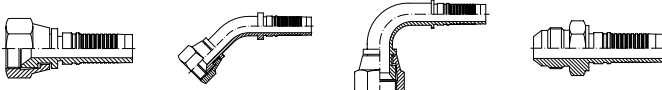

64142

64139

64138

64140

■ Conexiones Métricas DIN 2353 / Metric fittings DIN 2353 / Embouts Métriques DIN 2353 / Raccordi Metrici DIN 2353

65

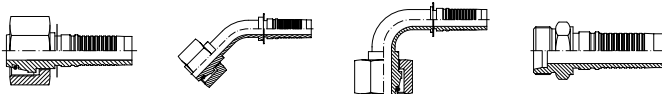

64204

64206

64205

64203

■ Racores para martillo / Fittings for hammer / Embouts pour marteau / Raccordi per martello

66

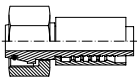

NAM

■ Conexiones ORFS / ORFS fittings / Embouts ORFS / Raccordi ORFS

66

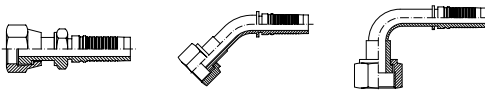

64900

64908

64907

■ Bidas SAE 3000/6000 PSI / 3000/6000 PSI SAE Flanges / Embouts brides SAE 3000/6000 PSI / Flangia SAE 3000/6000 PSI

67

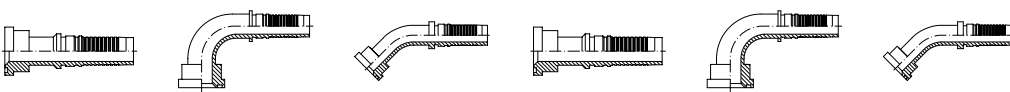

64182

64183

64184

64282

64283

64284

■ Bidas 9000 PSI / 9000 PSI Flanges / Embouts brides 9000 PSI / Flangia 9000 PSI

68

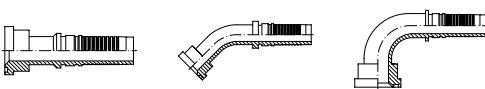

64382

64384

64383

Conexiones Serie Interlock

Interlock series fittings
 Embouts à sertir Interlock
 Raccordi serie Interlock

- Bridas Poclairn / Poclairn flanges / Embouts brides Poclairn / Flangia Poclairn

| 69

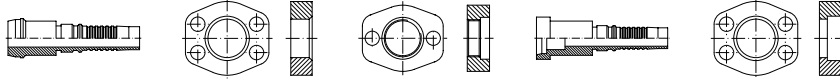

64801

44805

44807

64802

44806

Conexiones Alta presión (700 Bar)

High pressure 700 Bar fittings
 Embouts haute pression 700 Bar
 Raccordi altissima pressione (700 Bar)

- Casquillos / Ferrules / Jupes à sertir / Boccole

| 70

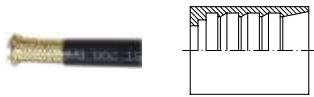

MT700

71012

- Conexiones / Fittings / Embouts / Raccordi

| 70

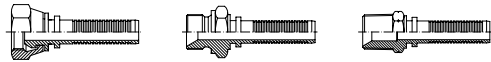

74100

74112

74161

Conexiones Serie 43 una sola pieza 1SN / 2SN / R16 / 2SC / 3TE / R17

One piece fittings 43 Series 1SN / 2SN / R16 / 2SC / 3TE / R17

Embouts pré-sertis Série 43 1SN / 2SN / R16 / 2SC / 3TE / R17

Raccordi un pezzo Serie 43 1SN / 2SN / R16 / 2SC / 3TE / R17

- Casquillos para racores de una sola pieza / Ferrules for one piece fittings / Jupes pour embouts pré-sertis / Boccole per raccordi un pezzo | 72

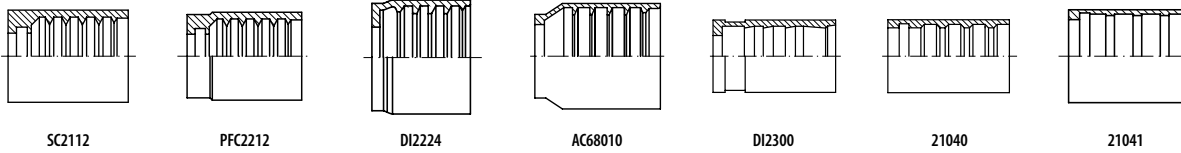

- Conexiones una sola pieza JIC 37° / One piece JIC 37° fittings / Embouts pré-sertis JIC 37° / Raccordi un pezzo JIC 37° | 74

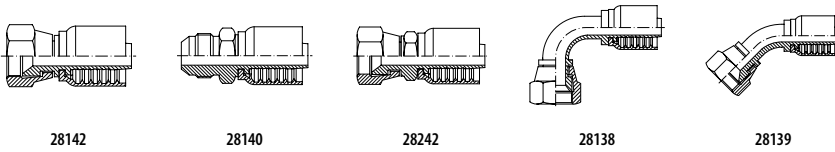

- Conexiones una sola pieza NPT-NPSM / One piece NPT-NPSM fittings / Embouts pré-sertis NPT-NPSM / Raccordi un pezzo NPT-NPSM | 75

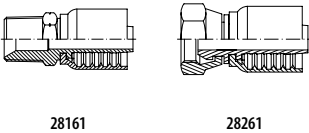

- Conexiones una sola pieza ORFS / One piece ORFS fittings / Embouts pré-sertis ORFS / Raccordi un pezzo ORFS | 76

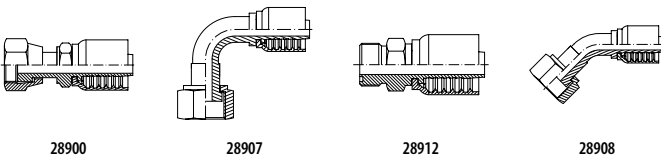

- Conexiones una sola pieza Bidas SAE 3000/6000 PSI / One piece SAE Flanges fittings 3000/6000 PSI / Embouts pré-sertis Bidas SAE 3000/6000 PSI / Raccordi un pezzo Flange SAE 3000/6000 PSI | 77

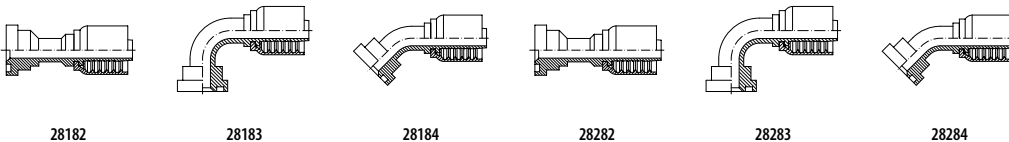

- Conexiones una sola pieza Bidas SAE 9000 PSI / One piece SAE Flanges fittings 9000 PSI / Embouts pré-sertis Bidas SAE 9000 PSI / Raccordi un pezzo Flange SAE 9000 PSI | 78

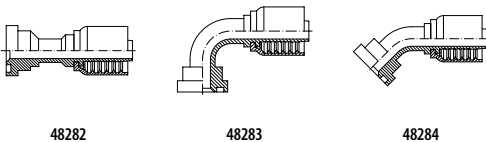

- Conexiones una sola pieza Métricas / One piece Metric fittings / Embouts pré-sertis Métriques / Raccordi un pezzo Metrici | 79

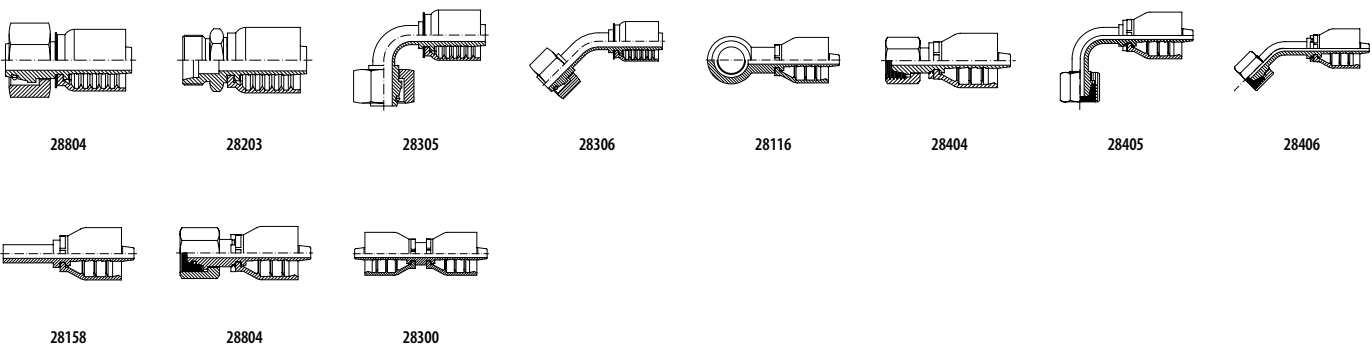

Conexiones Serie 43 una sola pieza 1SN / 2SN / R16 / 2SC / 3TE / R17

One piece fittings 43 Series 1SN / 2SN / R16 / 2SC / 3TE / R17

Embouts pré-sertis Série 43 1SN / 2SN / R16 / 2SC / 3TE / R17

Raccordi un pezzo Serie 43 1SN / 2SN / R16 / 2SC / 3TE / R17

■ Conexiones una sola pieza BSP - BSPT / One piece BSP - BSPT fittings / Embouts pré-sertis BSP - BSPT / Raccordi un pezzo BSP - BSPT | 82

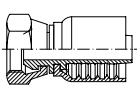

28100

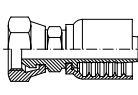

28400

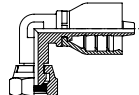

28127

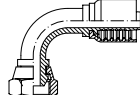

28107

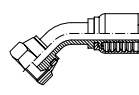

28108

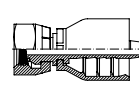

28110

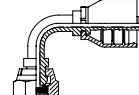

28117

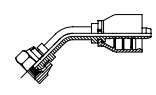

28118

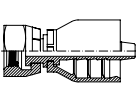

28200

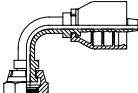

28207

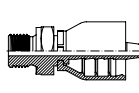

28212

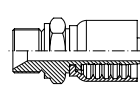

28112

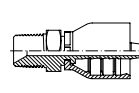

28114

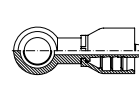

28111

Conexiones Serie BW una sola pieza R12 / 4SP / 4SH

One piece fittings BW series R12 / 4SP / 4SH

Embouts pré-sertis Série BW R12 / 4SP / 4SH

Raccordi BW - 1 pezzo R12 / 4SP / 4SH

■ Conexiones JIC 37° / JIC 37° Fittings / Embouts JIC 37° / Raccordi JIC 37°

86

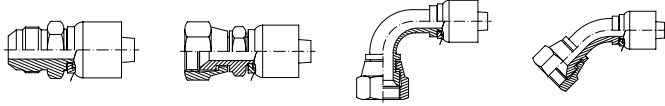

68140

68242

68138

68139

■ Conexiones ORFS / ORFS Fittings / Embouts ORFS / Raccordi ORFS

86

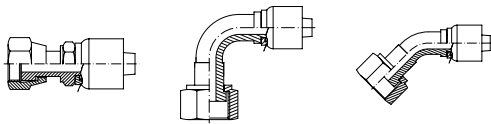

68901

68907

68908

■ Bridas SAE 3000/6000 PSI / SAE Flanges 3000/6000 PSI / Brides SAE 3000/6000 PSI / Flangia SAE 3000/6000 PSI

87

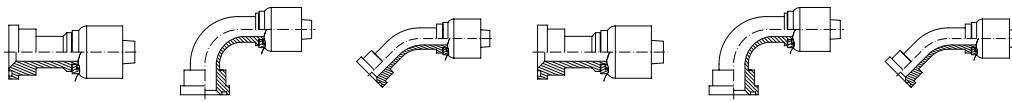

68182

68183

68184

68282

68283

68284

■ Conexiones Métricas DIN 2353 / Metric fittings / Embouts Métriques / Raccordi Metrici DIN 2353

88

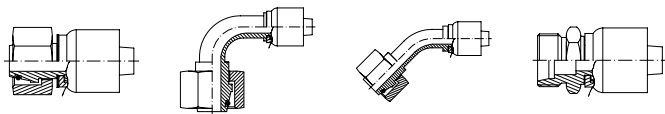

68204

68205

68206

68203

■ Conexiones BSP / BSP Fittings / Embouts BSP / Raccordi BSP

88

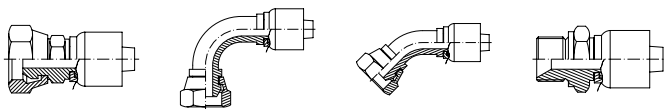

68110

68107

68108

68112

Conexiones Serie Standard

Standard series fittings
Embouts série Standard
Raccordi serie Standard

Casquillos R1AT/R2AT/1SN/2SN/2SC/R16/3TE

Ferrules R1AT/R2AT/1SN/2SN/2SC/R16/3TE

Jupes à sertir R1AT/R2AT/1SN/2SN/2SC/R16/3TE

Boccole a pressione per R1AT/R2AT/1SN/2SN/2SC/R16/3TE

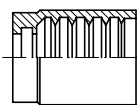

DN	Part nº Referencia	€
3/16"	DI221200300	1,18
1/4"	DI221200400	0,96
5/16"	DI221200501	0,96
3/8"	DI221200600	1,11
1/2"	DI221200800	1,30
5/8"	DI221201000	1,76
3/4"	DI221201200	2,62
1"	DI221201600	5,35
1"1/4	DI221202000	14,45
1"1/2	DI221202400	20,83
2"	DI221203200	25,59
2" 1/2	DI221204000	39,25
3"	DI221204800	47,69

Casquillos R4

Ferrules R4

Jupes à sertir R4

Boccole a pressione per R4

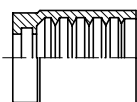

DN	Part nº Referencia	€
3/4"	DI221201200R4	7,40

Para otros tamaños, consultar tabla de prensado en nuestra web. / For other sizes, please check out the crimping table on our website. / Pour les autres dimensions, voir tableau de sertissage disponible sur notre site web. / Per altre dimensioni, vedere tabella di pressatura nel ns. sito web

Casquillos R6, R7, R8 y malla metálica

Ferrules SAE 100 R6, R7, R8 and steel braid

Jupes à sertir R6, R7, R8 et tresse métallique

Boccole a pressione per SAE R6, R7, R8 e Treccia Metallica

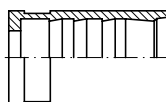

DN	Part nº Referencia	€
1/8"	DI2300200	1,05
3/16"	DI2300300	0,84
1/4"	DI2300400	0,80
5/16"	DI2300500	1,47
3/8"	DI2300600	1,19
1/2"	DI2300800	1,53
5/8"	DI2301000	2,82
3/4"	DI2301200	4,56
1"	DI2301600	7,89

Casquillos 1SC/1SN/2SC/R6/2TE

Ferrules 1SC/1SN/2SC/R6/2TE

Jupes à sertir 1SC/1SN/2SC/R6/2TE

Boccole a pressione per 1SC/1SN/2SC/R6/2TE

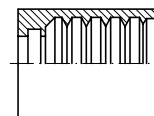

DN	Part nº Referencia	€
1/4"	SC21120400	1,23
5/16"	SC21120500	1,10
3/8"	SC21120600	1,32
1/2"	SC21120800	1,91
5/8"	SC21121000	2,60
3/4"	SC21121200	3,39
1"	SC21121600	5,83

Casquillos R2A/R9R/2ST/4SP

Ferrules R2A/R9R/2ST/4SP

Jupes à sertir R2A/R9R/2ST/4SP

Boccole a pressione per R2A/R9R/2ST/4SP

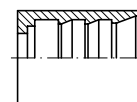

DN	Part nº Referencia	€
1/4"	DI122400400	1,24
5/16"	DI122400500	1,65
3/8"	DI122400600	1,44
1/2"	DI122400800	1,95
5/8"	DI122401000	2,49
3/4"	DI122401200	3,99
1"	DI122401600	6,28
1"1/4	DI122402000	14,77
1"1/2	DI122402400	17,61
2"	DI122403200	29,65

Casquillos R12/3SP/4SP/4SH no pelar

Ferrules R12/3SP/4SP/4SH non skive

Jupes à sertir R12/3SP/4SP/4SH sans dénudage

Boccole a pressione per R12/3SP/4SP/4SH senza spellatura

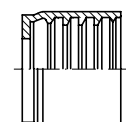

DN	Part nº Referencia	€
3/8"	DI222400600	2,19
1/2"	DI222400800	2,58
5/8"	DI222401000	3,31
3/4"	DI222401200	4,43
1"	DI222401600	7,23
1" 1/4	DI222402000	*

■ **CASQUILLO:** Reduce costes y tiempo de montaje

■ **FERRULES:** Simplify assembly and save money

NO PELAR | NO SKIVING
3SP | 4SP | R12 | 4SH

ESPIGA STANDARD | STANDARD SERIES



+



DI2224...

Consulta en nuestra ficha técnica datos | Check our technical sheet for data

* Consultar / *On request / *Sur demande / *Su richiesta

Conexiones Serie Standard

Standard series fittings
Embouts série Standard
Raccordi serie Standard

Hoses

Flexible hose fittings

Flow measuring

Equipment for flexible hoses

Casquillos PTFE Liso alta presión SAE 100 R14

Ferrules for Smooth PTFE SAE 100 R14

Jupes à sertir pour PTFE Lisse haute pression SAE 100 R14

Boccole a pressare per tubo al PTFE Liscio alta pressione SAE 100 R14

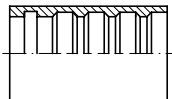

DN	Part nº Referencia	€
3/16"	210400300	1,37
1/4"	210400400	1,02
5/16"	210400500	1,43
3/8"	210400600	1,24
1/2"	210400800	1,67
5/8"	210401000	2,18
3/4"	210401200	2,84
1"	210401600	5,11

Casquillos PTFE Corrugado alta presión

Ferrules for Corrugated PTFE

Jupes à sertir PTFE Convoluté haute pression

Boccole a pressare per tubo al PTFE Corrugato alta pressione

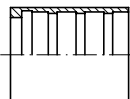

DN	Part nº Referencia	€
1/4"	210410400	1,38
3/8"	210410600	1,59
1/2"	210410800	1,78
5/8"	210411000	3,11
3/4"	210411201	3,19
1"	210411600	5,45
1" 1/4	210412001	11,55
1" 1/2	210412400	13,51
2"	210413200	23,06

Casquillos PTFE liso doble malla alta presión

Ferrules for Smooth PTFE high pressure hose with two braids

Jupes à sertir pour PTFE Lisse double tresse haute pression

Boccole a pressare per tubo al PTFE Liscio doppia treccia alta pressione

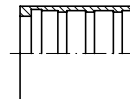

DN	Part nº Referencia	€
1/4"	210450400	0,97
3/8"	210450600	1,11

Para otros tamaños, consultar tabla de prensado en nuestra web. / For other sizes, please check out the crimping table on our website. / Pour les autres dimensions, voir tableau de sertissage disponible sur notre site web. / Per altre dimensioni, vedere tabella di pressatura nel ns. sito web



SAE 100 R4

3/4"	1"	1" 1/4 1" 1/2 2"
DI2212...R4	DI2212...	DI1224...

PTFE 2 MALLAS | FHM 2 BRAIDS

1/4" 3/8"	5/16" 3/4" 1"	1/2" 5/8"
21045...	DI23...	21040...

Datos de tablas de prensado siempre actualizados en nuestra web: www.dicsaes.com / Crimping information always updated on our website www.dicsaes.com

Conexiones Serie Standard

Standard series fittings
Embouts série Standard
Raccordi serie Standard

Hembras giratorias rectas BSP cono 60°

BSP Swivel female 60° cone

Femelle tournante gaz cyl BSP 60°

Femmina diritta BSP sede 60°

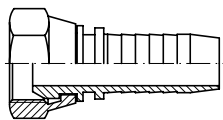

DN	THREAD ROSCA	Part nº Referencia	€
1/8"	1/8" BSP	241000202	1,62
3/16"	1/8" BSP	241000203	1,34
1/4"	1/8" BSP	241000204	1,65
3/16"	1/4" BSP	241000403	1,68
1/4"	1/4" BSP	241000404	1,34
5/16"	1/4" BSP	241000405	1,72
3/8"	1/4" BSP	241000406	2,15
1/4"	3/8" BSP	241000604	1,99
5/16"	3/8" BSP	241000605	1,85
3/8"	3/8" BSP	241000606	1,73
1/2"	3/8" BSP	241000608	2,22
1/4"	1/2" BSP	241000804	2,64
3/8"	1/2" BSP	241000806	2,42
1/2"	1/2" BSP	241000808	2,34
5/8"	1/2" BSP	241000810	3,47
1/2"	5/8" BSP	241001008	3,69
5/8"	5/8" BSP	241001010	3,32
1/2"	3/4" BSP	241001208	4,33
5/8"	3/4" BSP	241001210	4,00
3/4"	3/4" BSP	241001212	4,18
3/4"	1" BSP	241001612	7,22
1"	1" BSP	241001616	7,01
2"	2" 1/2 BSP	241004032	62,26
2" 1/2	2" 1/2 BSP	241004040	62,26
3"	3" BSP	241004848	71,83

Para medidas de 1" 1/4, 1" 1/2 y 2" ver con junta / For sizes of 1" 1/4, 1" 1/2 y 2" see with o'ring / Pour les dimensions de 1" 1/4, 1" 1/2 y 2" voir avec o'ring / Per quelli di 1" 1/4, 1" 1/2 y 2" vedere con o'ring

Hembras giratorias 45° BSP cono 60°

BSP Swivel female 60° cone (45° Elbow)

Coude 45° femelle tournante gaz cyl BSP 60°

Femmina a 45° BSP sede 60°

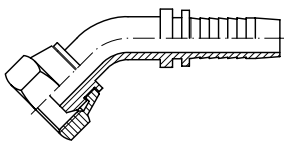

DN	THREAD ROSCA	Part nº Referencia	€
3/16"	1/8" BSP	241080203	2,93
1/4"	1/8" BSP	241080204	2,12
3/16"	1/4" BSP	241080403	2,93
1/4"	1/4" BSP	241080404	2,27
1/4"	3/8" BSP	241080604	3,58
5/16"	3/8" BSP	241080605	3,38
3/8"	3/8" BSP	241080606	3,21
3/8"	1/2" BSP	241080806	4,37
1/2"	1/2" BSP	241080808	4,61
1/2"	5/8" BSP	241081008	6,86
5/8"	5/8" BSP	241081010	6,86
5/8"	3/4" BSP	241081210	8,27
3/4"	3/4" BSP	241081212	8,83
3/4"	1" BSP	241081612	14,80
1"	1" BSP	241081616	13,78

Para aquellas mayores de 1" ver con junta / For those bigger than 1" see with o'ring / Pour ceux plus grand que 1" voir avec o'ring / Per quelli più grandi di 1" vedere con o'ring

Hembras giratorias 90° BSP cono 60°

BSP Swivel female 60° cone (90° Elbow)

Coude 90° femelle tournante gaz cyl BSP 60°

Femmina a 90° BSP sede 60°

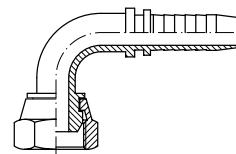

DN	THREAD ROSCA	Part nº Referencia	€
3/16"	1/8" BSP	241070203	2,81
1/4"	1/8" BSP	241070204	2,09
3/16"	1/4" BSP	241070403	2,60
1/4"	1/4" BSP	241070404	2,23
1/4"	3/8" BSP	241070604	3,07
5/16"	3/8" BSP	241070605	3,38
3/8"	3/8" BSP	241070606	2,86
1/4"	1/2" BSP	241070804	4,92
3/8"	1/2" BSP	241070806	3,76
1/2"	1/2" BSP	241070808	3,68
1/2"	5/8" BSP	241071008	7,55
5/8"	5/8" BSP	241071010	6,71
1/2"	3/4" BSP	241071208	7,50
5/8"	3/4" BSP	241071210	7,36
3/4"	3/4" BSP	241071212	7,32
3/4"	1" BSP	241071612	13,19
1"	1" BSP	241071616	13,68

Para aquellas mayores de 1" ver con junta / For those bigger than 1" see with o'ring / Pour ceux plus grand que 1" voir avec o'ring / Per quelli più grandi di 1" vedere con o'ring

Hembras giratorias rectas BSP cono 60° con junta tórica tuerca libre

BSP Swivel female 60° with o'ring, loose nut

Femelle tournante droite gaz cyl BSP 60° + o'ring, écrou libre

Femmina diritta BSP sede 60° con o'ring, dado libero

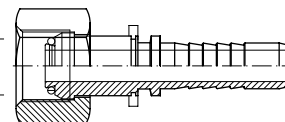

DN	THREAD ROSCA	Part nº Referencia	€
1/4"	1/4" BSP	241100404L	3,25
3/8"	3/8" BSP	241100606L	5,26
1/2"	1/2" BSP	241100808L	5,08

Hembras giratorias 90° BSP cono 60° con junta tórica tuerca libre

BSP Swivel female 60° with o'ring, loose nut (90° Elbow)

Coude 90° femelle tournante gaz cyl BSP 60° + o'ring, écrou libre

Femmina a 90° BSP sede 60° con o'ring, dado libero

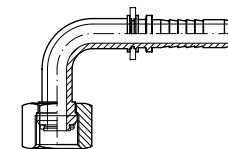

DN	THREAD ROSCA	Part nº Referencia	€
1/4"	1/4" BSP	241170404L	6,77
3/8"	3/8" BSP	241170606L	7,58
1/2"	1/2" BSP	241170808L	10,38

Conexiones Serie Standard

Standard series fittings
Embouts série Standard
Raccordi serie Standard

Hoses

Flexible hose fittings

Flow measuring

Equipment for flexible hoses

Hembras giratorias rectas BSP cono 60° con junta tórica

BSP Swivel female 60° with o'ring

Femelle tournante droit gaz cyl BSP 60° + o'ring

Femmina diritta BSP sede 60° con o'ring

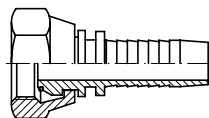

DN	THREAD ROSCA	Part n° Referencia	€
1/4"	1/4" BSP	241100404	1,95
3/8"	3/8" BSP	241100606	2,21
1/2"	1/2" BSP	241100808	3,24
5/8"	5/8" BSP	241101010	5,12
5/8"	3/4" BSP	241101210	4,74
3/4"	3/4" BSP	241101212	4,30
1"	1" BSP	241101616	9,44
1"	1"1/4 BSP	241102016	16,39
1"1/4	1"1/4 BSP	241102020	17,16
1" 1/4	1" 1/2 BSP	241102420	22,52
1"1/2	1"1/2 BSP	241102424	22,30
1"1/2	2" BSP	241103224	40,28
2"	2" BSP	241103232	40,53

Hembras giratorias 45° BSP cono 60° con junta tórica

BSP Swivel female 60° cone with o'ring (45° Elbow)

Coude 45° femelle tournante gaz cyl BSP 60° + o'ring

Femmina a 45° BSP sede 60° con o'ring

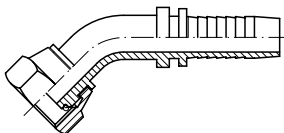

DN	THREAD ROSCA	Part n° Referencia	€
3/8"	3/8" BSP	241180606	3,24
1/2"	1/2" BSP	241180808	4,15
5/8"	5/8" BSP	241181010	8,23
3/4"	3/4" BSP	241181212	13,46
1"	1" BSP	241181616	15,09
1"1/4	1"1/4 BSP	241182020	21,69
1"1/2	1"1/2 BSP	241182424	29,71
1"1/2	2" BSP	241183224 *	95,60
2"	2" BSP	241183232	48,21

*Hasta fin de existencias. / *Until end of stock. / *Jusqu'à la fin du stock. / *Fino ad esaurimento scorta.

Hembras giratorias 90° BSP cono 60° con junta tórica

BSP Swivel female 60° cone with o'ring (90° Elbow)

Coude 90° femelle tournante gaz cyl BSP 60° + o'ring

Femmina a 90° BSP sede 60° con o'ring

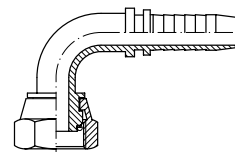

DN	THREAD ROSCA	Part n° Referencia	€
1/4"	1/4" BSP	241170404	3,41
3/8"	3/8" BSP	241170606	4,41
1/2"	1/2" BSP	241170808	6,17
5/8"	5/8" BSP	241171010	8,23
3/4"	3/4" BSP	241171212	9,98
1"	1" BSP	241171616	17,63
1"	1"1/4 BSP	241172016	27,28
1"1/4	1"1/4 BSP	241172020	32,01
1"1/4	1"1/2 BSP	241172420	47,43
1"1/2	1"1/2 BSP	241172424	37,14
2"	2" BSP	241173232	88,38

Hembras giratorias BSP 60° doble hexagono

BSP Swivel female 60° cone double hex.

Femelle tournante BSP cône 60° double hexagonal

Femmina diritta BSP sede 60° doppio esagono

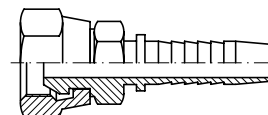

DN	THREAD ROSCA	Part n° Referencia	€
1/4"	1/4" BSP	244000404	2,52
5/16"	3/8" BSP	244000605	2,86
3/8"	3/8" BSP	244000606	3,07
1/2"	1/2" BSP	244000808	3,77
3/4"	3/4" BSP	244001212	7,80
1"	1" BSP	244001616	10,40
1"1/4	1"1/4 BSP	244002020	22,84
1"1/2	1"1/2 BSP	244002424	34,55
2"	2" BSP	244003232	57,85

NOVEDAD: Disponibles en diámetros 2" 1/2 - 3"
NEW: Larger diameters available 2" 1/2 - 3"



EN 853 2SN / SAE 100 R2AT
MS3511...



R1AT/R2AT/1SN/2SN/2SC/R16/3TE
DI2212...



BSP (60°)
24100...



BSP (60°)
A1020... | A1010...

Consulta en nuestra ficha técnica. | Check our technical sheet for data options.

Conexiones Serie Standard

Standard series fittings
Embouts série Standard
Raccordi serie Standard

Hembras giratorias rectas BSP asiento plano

BSP Swivel female flat seat

Femelle tournante fond plat BSP

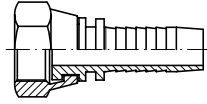

Femmina diritta BSP sede piana

DN	THREAD ROSCA	Part nº Referencia	€
1/4"	1/4" BSP	242000404	1,77
5/16"	3/8" BSP	242000605	2,41
3/8"	3/8" BSP	242000606	2,41
3/8"	1/2" BSP	242000806	3,29
1/2"	1/2" BSP	242000808	3,29
1/2"	3/4" BSP	242001208	4,77
3/4"	3/4" BSP	242001212	5,17
1"	1" BSP	242001616	8,38
1" 1/4	1" 1/4 BSP	242002020	18,37
1" 1/2	1" 1/2 BSP	242002424	24,10

Macho rosca cilíndrica BSP asiento plano

BSP Male flat seat

Mâle fixe gaz cyl fond plat

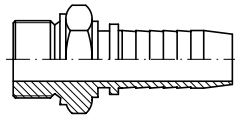

Maschio BSP cilindrico sede piana

DN	THREAD ROSCA	Part nº Referencia	€
1/4"	1/4" BSP	242120404	2,53
3/8"	3/8" BSP	242120606	3,32
3/8"	1/2" BSP	242120806	4,65
1/2"	1/2" BSP	242120808	4,45
3/4"	3/4" BSP	242121212	6,77
1"	1" BSP	242121616	12,53

Hembras giratorias 90° BSP asiento plano

BSP Swivel female flat seat (90° Elbow)

Embout à sertir coude 90° femelle tournante fond plat BSP

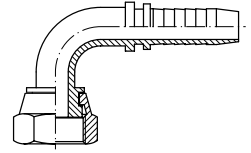

Femmina a 90° BSP sede 60° sede piana

DN	THREAD ROSCA	Part nº Referencia	€
1/4"	1/4" BSP	242070404	2,90
3/8"	3/8" BSP	242070606	3,94
1/2"	1/2" BSP	242070808	4,57
3/4"	3/4" BSP	242071212	10,37
1"	1" BSP	242071616	18,56

Hembras giratorias 90° BSP cono 60° (forja)

BSP Swivel female 60° cone forge (90° Elbow)

Coude 90° femelle tournante forge gaz cyl BSP 60°

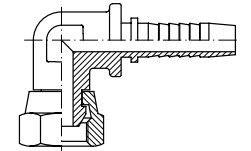

Femmina a 90° BSP sede 60° (forgiatta)

DN	THREAD ROSCA	Part nº Referencia	€
1/4"	1/4" BSP	241270404	3,95
5/16"	3/8" BSP	241270605	3,95
3/8"	3/8" BSP	241270606	4,92
5/16"	1/2" BSP	241270806	4,86
1/2"	1/2" BSP	241270808	6,16
5/8"	3/4" BSP	241271210	8,10
3/4"	3/4" BSP	241271212	10,40

Conexiones Serie Standard

Standard series fittings
Embouts série Standard
Raccordi serie Standard

Hoses

Flexible hose fittings

Flow measuring

Equipment for flexible hoses

Macho rosca cilíndrica BSP cono 60°

BSP Male parallel 60° cone

Mâle fixe gaz cyl BSP 60°

Maschio BSP cilindrico sede 60°

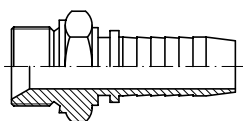

DN	THREAD ROSCA	Part nº Referencia	€
3/16"	1/8" BSP	241120203	1,39
1/4"	1/8" BSP	241120204	1,60
1/8"	1/4" BSP	241120402	5,59
3/16"	1/4" BSP	241120403	3,26
1/4"	1/4" BSP	241120404	1,44
3/8"	1/4" BSP	241120406	2,34
1/4"	3/8" BSP	241120604	2,13
5/16"	3/8" BSP	241120605	2,12
3/8"	3/8" BSP	241120606	1,88
1/2"	3/8" BSP	241120608	2,60
1/4"	1/2" BSP	241120804	2,94
3/8"	1/2" BSP	241120806	2,57
1/2"	1/2" BSP	241120808	2,57
1/2"	5/8" BSP	241121008	5,22
5/8"	5/8" BSP	241121010	4,17
1/2"	3/4" BSP	241121208	5,11
5/8"	3/4" BSP	241121210	5,12
3/4"	3/4" BSP	241121212	4,43
3/4"	1" BSP	241121612	9,94
1"	1" BSP	241121616	7,39
1"	1"1/4 BSP	241122016	19,49
1"1/4"	1"1/4 BSP	241122020	18,93
1"1/2"	1"1/2 BSP	241122424	20,42
2"	2" BSP	241123232	49,32

Orientable BSP

Banjo BSP

Embout Banjo droit gaz

Raccordo ad occhio BSP

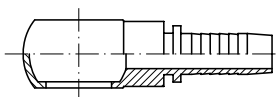

DN	Ø	Part nº Referencia	€
3/16"	1/4" BSP	241110403	2,84
1/4"	1/4" BSP	241110404	2,41
5/16"	1/4" BSP	241110405	2,97
3/8"	1/4" BSP	241110406	2,97
1/4"	3/8" BSP	241110604	3,62
5/16"	3/8" BSP	241110605	3,92
3/8"	3/8" BSP	241110606	3,12
1/2"	3/8" BSP	241110608	3,51
3/8"	1/2" BSP	241110806	5,11
1/2"	1/2" BSP	241110808	5,15
5/8"	5/8" BSP	241111010	10,61
1/2"	3/4" BSP	241111208	11,40
5/8"	3/4" BSP	241111210	12,54
3/4"	3/4" BSP	241111212	12,54
1"	1" BSP	241111616	27,48

Macho rosca cónica BSPT

BSPT Male tapered

Mâle fixe gaz conique BSPT

Maschio BSPT conico

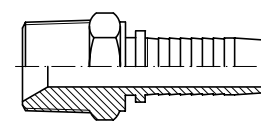

DN	THREAD ROSCA	Part nº Referencia	€
3/16"	1/8" BSPT	241140203	1,25
1/4"	1/8" BSPT	241140204	1,16
1/4"	1/4" BSPT	241140404	1,16
1/4"	3/8" BSPT	241140604	1,86
5/16"	3/8" BSPT	241140605	1,88
3/8"	3/8" BSPT	241140606	1,75
3/8"	1/2" BSP	241140806	2,33
1/2"	1/2" BSPT	241140808	2,42
5/8"	3/4" BSPT	241141210	4,08
3/4"	3/4" BSPT	241141212	4,65
3/4"	1" BSPT	241141612	8,35
1"	1" BSPT	241141616	9,31
1"	1"1/4 BSPT	241142016	15,11
1" 1/4"	1"1/4 BSPT	241142020	17,58
1" 1/2"	1" 1/2 BSPT	241142424	17,25
2"	2" BSPT	241143232	43,03

Tornillo orientable simple BSP

BSP bolt for Banjo

Vis creuse simple pour banjo filetage gaz BSP

Bullone forato BSP

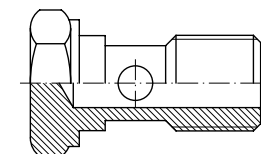

THREAD ROSCA	Part nº Referencia	€
1/8" BSP	A109002	*
1/4" BSP	A109004	*
3/8" BSP	A109006	*
1/2" BSP	A109008	*
5/8" BSP	A109010	*
3/4" BSP	A109012	*
1" BSP	A109016	*
1"1/4 BSP	A109020	*
1"1/2 BSP	A109024	*

*Ver precios en p.292 (ADAPTADORES BSP) / *See prices in p.292 (BSP ADAPTORS) / *Prix à la p.292 (ADAPTEURS BSP) / *Vedere prezzi p.292 (ADATTATORI BSP)

Conexiones Serie Standard

Standard series fittings
Embouts série Standard
Raccordi serie Standard

Hembras giratorias rectas JIC 37°

JIC Swivel female 37° cone

Femelle tournante droite JIC cône 37°

Femmina diritta JIC 37°

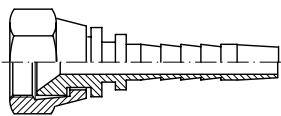

DN	THREAD ROSCA	Part n° Referencia	€
3/16"	7/16" 20h UNF	241420703	1,55
1/4"	7/16" 20h UNF	241420704	1,39
1/4"	1/2" 20h UNF	241420804	1,62
5/16"	1/2" 20h UNF	241420805	2,23
1/4"	9/16" 18h UNF	241420904	1,52
5/16"	9/16" 18h UNF	241420905	1,56
3/8"	9/16" 18h UNF	241420906	1,70
3/8"	5/8" 18h UNF	241421006	2,81
5/16"	3/4" 16h UNF	241421205	2,34
3/8"	3/4" 16h UNF	241421206	2,19
1/2"	3/4" 16h UNF	241421208	2,55
3/8"	7/8" 14h UNF	241421406	2,89
1/2"	7/8" 14h UNF	241421408	2,80
5/8"	7/8" 14h UNF	241421410	3,58
1/2"	1"1/16 12h UNF	241421708	4,76
5/8"	1"1/16 12h UNF	241421710	4,52
3/4"	1"1/16 12h UNF	241421712	4,06
1"	1"1/16 12h UNF	241421716	8,40
3/4"	1"5/16 12h UNF	241422112	9,15
1"	1"5/16 12h UNF	241422116	9,63
1"	1"5/8 12h UNF	241422616	15,01
1"1/4"	1"5/8 12h UNF	241422620	13,05
1"1/4"	1"7/8 12h UNF	241423020	29,33
1"1/2"	1"7/8 12h UNF	241423024	20,66
2"	2"1/2 12h UNF	241424032	37,50

Hembras giratorias rectas JIC 37° doble hexagono

JIC swivel female 37° cone double hex.

Femelle JIC 37° double hexagonal

Femmina diritta JIC 37° doppio esagono

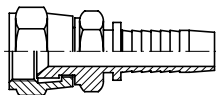

DN	THREAD ROSCA	Part n° Referencia	€
1/4"	7/16" 20h UNF	242420704	2,09
1/4"	1/2" 20h UNF	242420804	2,32
5/16"	9/16" 18h UNF	242420905	2,85
3/8"	9/16" 18h UNF	242420906	2,85
3/8"	3/4" 16h UNF	242421206	3,16
1/2"	3/4" 16h UNF	242421208	3,69
1/2"	7/8" 14h UNF	242421408	4,68
3/4"	1"1/16 12h UN	242421712	6,99
1"	1"5/16 12h UN	242422116	9,70
1"1/4"	1"5/8 12h UN	242422620	20,56
1"1/2"	1"7/8 12h UN	242423024	31,64
2"	2"1/2 12h UN	242424032	58,83

Hembras giratorias 90° JIC 37°

JIC Swivel female 37° cone (90° Elbow)

Coude 90° femelle tournante cône JIC 37°

Femmina a 90° JIC 37°

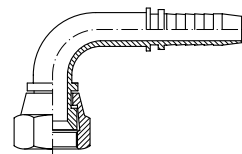

DN	THREAD ROSCA	Part n° Referencia	€
3/16"	7/16" 20h UNF	241380703	3,96
1/4"	7/16" 20h UNF	241380704	2,21
1/4"	1/2" 20h UNF	241380804	3,42
1/4"	9/16" 18h UNF	241380904	2,60
5/16"	9/16" 18h UNF	241380905	3,34
3/8"	9/16" 18h UNF	241380906	2,86
3/8"	5/8" 18h UNF	241381006	4,56
3/8"	3/4" 16h UNF	241381206	3,66
1/2"	3/4" 16h UNF	241381208	4,05
3/8"	7/8" 14h UNF	241381406	6,72
1/2"	7/8" 14h UNF	241381408	4,50
5/8"	7/8" 14h UNF	241381410	7,74
1/2"	1"1/16 12h UNF	241381708	10,95
5/8"	1"1/16 12h UNF	241381710	9,46
3/4"	1"1/16 12h UNF	241381712	8,83
3/4"	1"5/16 12h UNF	241382112	16,31
1"	1"5/16 12h UNF	241382116	13,89
1"	1"5/8 12h UNF	241382616	28,80
1"1/4"	1"5/8 12h UNF	241382620	27,84
1"1/4"	1"7/8 12h UNF	241383020	44,78
1"1/2"	1"7/8 12h UNF	241383024	40,28
2"	2"1/2 12h UNF	241384032	85,61

Hembras giratorias 45° JIC 37°

JIC swivel female 37° cone (45° Elbow)

Coude 45° femelle tournante cône JIC 37°

Femmina a 45° JIC 37°

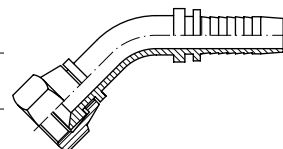

DN	THREAD ROSCA	Part n° Referencia	€
1/4"	7/16" 20h UNF	241390704	2,78
1/4"	1/2" 20h UNF	241390804	3,34
1/4"	9/16" 18h UNF	241390904	3,38
5/16"	9/16" 18h UNF	241390905	3,12
3/8"	9/16" 18h UNF	241390906	3,58
3/8"	3/4" 16h UNF	241391206	4,97
1/2"	3/4" 16h UNF	241391208	5,08
1/2"	7/8" 14h UNF	241391408	6,36
5/8"	7/8" 14h UNF	241391410	6,56
1/2"	1"1/16 12h UNF	241391708	10,59
5/8"	1"1/16 12h UNF	241391710	9,87
3/4"	1"1/16 12h UNF	241391712	8,55
3/4"	1"5/16 12h UNF	241392112	17,40
1"	1"5/16 12h UNF	241392116	15,11
1"	1"5/8 12h UNF	241392616	28,80
1"1/4"	1"5/8 12h UNF	241392620	32,46
1"1/4"	1"7/8 12h UNF	241393020	48,68
1"1/2"	1"7/8 12h UNF	241393024	48,68
2"	2"1/2 12h UNF	241394032	85,61

Conexiones Serie Standard

Standard series fittings
Embouts série Standard
Raccordi serie Standard

Macho JIC 37°

Male JIC 37° cone

Mâle fixe JIC cône 37°

Maschio JIC 37°

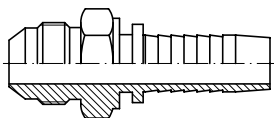

DN	THREAD ROSCA	Part n° Referencia	€
1/4"	7/16" 20h UNF	241400704	1,29
1/4"	1/2" 20h UNF	241400804	2,32
5/16"	1/2" 20h UNF	241400805	2,15
1/4"	9/16" 18h UNF	241400904	1,59
5/16"	9/16" 18h UNF	241400905	1,83
3/8"	9/16" 18h UNF	241400906	1,48
3/8"	3/4" 16h UNF	241401206	2,16
1/2"	3/4" 16h UNF	241401208	1,96
3/8"	7/8" 14h UNF	241401406	3,08
1/2"	7/8" 14h UNF	241401408	2,69
5/8"	7/8" 14h UNF	241401410	3,18
1/2"	1"1/16 12h UNF	241401708	4,76
5/8"	1"1/16 12h UNF	241401710	4,31
3/4"	1"1/16 12h UNF	241401712	5,57
3/4"	1"5/16 12h UNF	241402112	7,97
1"	1"5/16 12h UNF	241402116	10,04
1"	1"5/8 12h UNF	241402616	16,30
1"1/4	1"5/8 12h UNF	241402620	17,84
1"1/4	1"7/8 12h UNF	241403020	25,17
1"1/2	1"7/8 12h UNF	241403024	25,17
2"	2"1/2 12h UNF	241404032	46,62

Espigas de prensar dobles

Double hose tail for crimping

Embout double jonction

Giunzione tubo-tubo

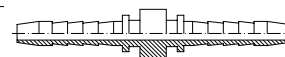

DN	Part n° Referencia	€
1/4"	243000404	1,29
5/16"	243000505	1,95
3/8"	243000606	2,03
1/2"	243000808	2,37
3/4"	243001212	8,37
1"	243001616	13,51

Machos Stecko

Stecko male connections

Mâle fixe Stecko

Maschio Stecko

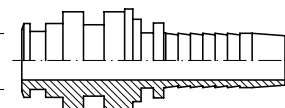

DN	STECKO	Part n° Referencia	€
1/4"	1/4"	241900404	2,56
3/8"	3/8"	241900606	4,04
1/2"	1/2"	241900808	7,78
3/4"	3/4"	241901212	8,24

Conexiones Serie Standard

Standard series fittings
Embouts série Standard
Raccordi serie Standard

Hembras giratorias Métricas cono 24° con junta tórica

Metric swivel female 24° cone with o'ring

Femelle tournante droite Métrique cône 24°
+ o'ring

Femmina Metrica sede 24° con o'ring

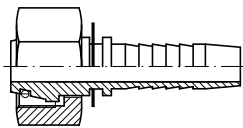

DN	PIPE TUBO	SERIE	THREAD ROSCA	Part nº Referencia	€
3/16"	6	L	12X1,5	24804120603	1,77
1/4"	6	L	12X1,5	24804120604	1,52
1/4"	8	L	14X1,5	24804140804	1,41
5/16"	8	L	14x1.5	24804140805	1,76
3/8"	8	L	14x1.5	24804140806	1,98
1/4"	10	L	16X1,5	24804161004	1,70
5/16"	10	L	16X1,5	24804161005	1,78
3/8"	10	L	16X1,5	24804161006	2,25
1/4"	12	L	18X1,5	24804181204	2,03
5/16"	12	L	18X1,5	24804181205	1,93
3/8"	12	L	18X1,5	24804181206	1,83
1/2"	12	L	18x1.5	24804181208	2,61
1/4"	15	L	22x1.5	24804221504	3,09
5/16"	15	L	22x1.5	24804221505	3,09
3/8"	15	L	22X1,5	24804221506	3,06
1/2"	15	L	22X1,5	24804221508	2,60
3/8"	18	L	26x1.5	24804261806	4,14
1/2"	18	L	26X1,5	24804261808	4,50
5/8"	18	L	26X1,5	24804261810	3,27
3/4"	18	L	26x1.5	24804261812	4,23
1/2"	22	L	30x2	24804302208	5,22
5/8"	22	L	30x2	24804302210	7,67
3/4"	22	L	30X2	24804302212	5,02
3/4"	28	L	36x2	24804362812	7,01
1"	28	L	36X2	24804362816	9,82
1"	35	L	45x2	24804453516	12,16
1 1/4"	35	L	45X2	24804453520	15,11
1 1/4"	42	L	42x2	24804524220	18,95
1 1/2"	42	L	52X2	24804524224	20,84
2"	42	L	52x2	24804524232	22,46
1/4"	6	S	14x1.5	24804140604	1,69
3/16"	8	S	16X1,5	24804160803	2,28
1/4"	8	S	16X1,5	24804160804	1,82
5/16"	8	S	16x1.5	24804160805	1,98
3/8"	8	S	16x1.5	24804160806	2,13
1/4"	10	S	18X1,5	24804181004	2,27
5/16"	10	S	18x1.5	24804181005	2,12
3/8"	10	S	18x1,5	24804181006	2,57
1/4"	12	S	20x1,5	24804201204	2,57
5/16"	12	S	20X1,5	24804201205	1,93
3/8"	12	S	20X1,5	24804201206	2,01
1/2"	12	S	20X1,5	24804201208	4,87
5/16"	14	S	22x1.5	24804221405	3,07
3/8"	14	S	22X1,5	24804221406	2,89
1/2"	14	S	22x1,5	24804221408	2,81
1/4"	16	S	24x1.5	24804241604	3,07
5/16"	16	S	24x1.5	24804241605	3,67
3/8"	16	S	24x1.5	24804241606	3,25
1/2"	16	S	24X1,5	24804241608	3,22
5/8"	16	S	24x1.5	24804241610	3,35
3/8"	20	S	30x2	24804302006	5,25
1/2"	20	S	30x2	24804302008	4,34
5/8"	20	S	30X2	24804302010	4,14
3/4"	20	S	30X2	24804302012	5,80
1/2"	25	S	36x2	24804362508	9,54
5/8"	25	S	36x2	24804362510	7,57
3/4"	25	S	36X2	24804362512	9,23
1"	25	S	36X2	24804362516	11,45
5/8"	30	S	42x2	24804423010	8,67
3/4"	30	S	42x2	24804423012	8,86
1"	30	S	42X2	24804423016	13,51
1 1/4"	38	S	52X2	24804523820	19,57

Hembras giratorias 90° Métricas cono 24° con junta tórica

Metric swivel female 24° cone with o'ring (90° Elbow)

Coude 90° femelle tournante Métrique cône 24°
+ o'ring

Femmina Metrica a 90° sede 24° con o'ring

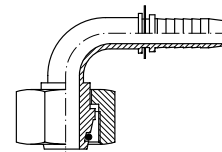

DN	PIPE TUBO	SERIE	THREAD ROSCA	Part nº Referencia	€
3/16"	6	L	12x1,5	24305120603	2,25
1/4"	6	L	12x1,5	24305120604	2,57
1/4"	8	L	14x1,5	24305140804	2,61
5/16"	8	L	14x1.5	24305140805	3,13
1/4"	10	L	16x1,5	24305161004	2,80
5/16"	10	L	16x1,5	24305161005	2,83
3/8"	10	L	16x1,5	24305161006	3,05
1/4"	12	L	18x1,5	24305181204	5,34
5/16"	12	L	18x1,5	24305181205	3,48
3/8"	12	L	18x1,5	24305181206	2,85
1/2"	12	L	18x1.5	24305181208	4,35
3/8"	15	L	22x1.5	24305221506	5,06
1/2"	15	L	22x1.5	24305221508	4,25
1/2"	18	L	26x1.5	24305261808	6,52
5/8"	18	L	26x1,5	24305261810	7,10
5/8"	22	L	30x2	24305302210	11,62
3/4"	22	L	30x2	24305302212	10,74
3/4"	28	L	36x2	24305362812	9,89
1"	28	L	36x2	24305362816	16,70
1 1/4"	35	L	45x2	24305453520	27,04
1 1/2"	42	L	52x2	24305524224	48,02
3/16"	6	S	14x1.5	24305140603	2,89
1/4"	8	S	16x1,5	24305160804	2,72
5/16"	8	S	16x1,5	24305160805	3,13
1/4"	10	S	18x1,5	24305181004	2,78
5/16"	10	S	18x1,5	24305181005	3,77
3/8"	10	S	18x1,5	24305181006	4,79
1/4"	12	S	20x1,5	24305201204	4,98
5/16"	12	S	20x1,5	24305201205	4,31
3/8"	12	S	20x1,5	24305201206	2,83
1/2"	12	S	20x1.5	24305201208	4,01
3/8"	14	S	22x1,5	24305221406	5,34
3/8"	16	S	24x1,5	24305241606	4,10
1/2"	16	S	24x1,5	24305241608	4,68
5/8"	20	S	30x2	24305302010	8,18
3/4"	20	S	30x2	24305302012	10,74
3/4"	25	S	36x2	24305362512	13,92
1"	25	S	36x2	24305362516	18,74
5/8"	30	S	42x2	24305423010	10,30
3/4"	30	S	42x2	24305423012	10,81
1"	30	S	42x2	24305423016	23,66
1 1/4"	38	S	52x2	24305523820	37,98

Conexiones Serie Standard

Standard series fittings
Embouts série Standard
Raccordi serie Standard

Hembras giratorias 45° Métricas cono 24° con junta tórica

Metric swivel female 24° cone with o'ring (45° Elbow)

Coude 45° femelle tournante Métrique cône 24°+ o'ring

Femmina Metrica a 45° sede 24° con o'ring

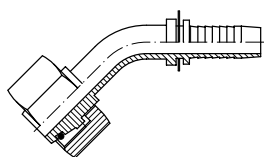

DN	PIPE TUBO	SERIE	THREAD ROSCA	Part nº Referencia	€
3/16"	6	L	12x1,5	24306120603	3,10
1/4"	6	L	12x1,5	24306120604	2,69
1/4"	8	L	14x1,5	24306140804	2,68
5/16"	8	L	14x1,5	24306140805	3,26
1/4"	10	L	16x1,5	24306161004	2,94
5/16"	10	L	16x1,5	24306161005	2,84
3/8"	10	L	16x1,5	24306161006	3,27
1/4"	12	L	18x1,5	24306181204	3,66
5/16"	12	L	18x1,5	24306181205	4,00
3/8"	12	L	18x1,5	24306181206	2,75
1/2"	12	L	18x1,5	24306181208	4,54
3/8"	15	L	22x1,5	24306221506	6,52
1/2"	15	L	22x1,5	24306221508	4,93
1/2"	18	L	26x1,5	24306261808	6,81
5/8"	18	L	26x1,5	24306261810	7,26
5/8"	22	L	30x2	24306302210	8,07
3/4"	22	L	30x2	24306302212	10,49
3/4"	28	L	36x2	24306362812	10,32
1"	28	L	36x2	24306362816	16,76
1 1/4"	35	L	45x2	24306453520	29,16
1 1/2"	42	L	52x2	24306524224	46,48
3/16"	6	S	14x1,5	24306140603	3,78
1/4"	6	S	14x1,5	24306140604	3,22
1/4"	8	S	16x1,5	24306160804	3,47
5/16"	8	S	16x1,5	24306160805	3,26
1/4"	10	S	18x1,5	24306181004	4,12
5/16"	10	S	18x1,5	24306181005	3,43
3/8"	10	S	18x1,5	24306181006	3,43
1/4"	12	S	20x1,5	24306201204	3,98
5/16"	12	S	20x1,5	24306201205	4,66
3/8"	12	S	20x1,5	24306201206	4,47
1/2"	12	S	20x1,5	24306201208	4,48
3/8"	14	S	22x1,5	24306221406	5,34
3/8"	16	S	24x1,5	24306241606	4,70
1/2"	16	S	24x1,5	24306241608	5,24
5/8"	20	S	30x2	24306302010	9,22
3/4"	20	S	30x2	24306302012	11,27
3/4"	25	S	36x2	24306362512	15,68
1"	25	S	36x2	24306362516	16,76
3/4"	30	S	42x2	24306423012	11,29
1"	30	S	42x2	24306423016	21,89
1 1/4"	38	S	52x2	24306523820	41,08

Machos fijos Métricos cono 24°

Male stud Metric thread 24° cone

Mâle fixe Métrique cône 24°

Maschio Metrico sede 24°

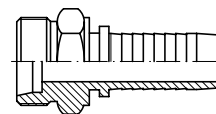

DN	PIPE TUBO	SERIE	THREAD ROSCA	Part nº Referencia	€
3/16"	6	L	12x1,5	24203120603	1,36
1/4"	6	L	12x1,5	24203120604	1,53
1/4"	8	L	14x1,5	24203140804	1,56
1/4"	10	L	16x1,5	24203161004	1,85
5/16"	10	L	16x1,5	24203161005	1,79
3/8"	10	L	16x1,5	24203161006	1,65
1/4"	12	L	18x1,5	24203181204	1,85
5/16"	12	L	18x1,5	24203181205	2,09
3/8"	12	L	18x1,5	24203181206	1,57
3/8"	15	L	22x1,5	24203221506	2,60
1/2"	15	L	22x1,5	24203221508	2,41
1/2"	18	L	26x1,5	24203261808	3,44
5/8"	18	L	26x1,5	24203261810	2,99
3/4"	22	L	30x2	24203302212	4,71
1"	28	L	36x2	24203362816	9,75
1 1/4"	35	L	45x2	24203453520	14,04
1 1/2"	42	L	52x2	24203524224	22,41
1/4"	8	S	16x1,5	24203160804	1,83
1/4"	10	S	18x1,5	24203181004	2,40
5/16"	10	S	18x1,5	24203181005	2,17
3/8"	10	S	18x1,5	24203181006	2,25
5/16"	12	S	20x1,5	24203201205	2,23
3/8"	12	S	20x1,5	24203201206	2,33
3/8"	14	S	22x1,5	24203221406	2,74
1/2"	16	S	24x1,5	24203241608	3,10
5/8"	20	S	30x2	24203302010	4,65
3/4"	20	S	30x2	24203302012	5,49
3/4"	25	S	36x2	24203362512	9,75
1"	25	S	36x2	24203362516	9,94
1"	30	S	42x2	24203423016	14,02
1 1/4"	38	S	52x2	24203523820	22,26

Ampliamos nuestra gama de **conexiones métricas**

We extend our range of **metric fittings**

Conexiones Serie Standard

Standard series fittings
Embouts série Standard
Raccordi serie Standard

Orientable Métrico Recto

Banjo metric

Banjo droit Métrique

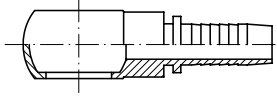

Raccordo ad occhio Metrico

DN	Ø	Part nº Referencia	€
3/16"	M10x1	241161003	2,39
1/4"	M10x1	241161004	2,39
5/16"	M10x1	241161005	2,41
1/8"	M12x1	241161202 *	9,50
3/16"	M12x1.5	241161203	2,46
1/4"	M12x1.5	241161204	2,70
1/4"	M14x1.5	241161404	2,70
5/16"	M14x1.5	241161405	2,99
3/8"	M14x1.5	241161406	3,29
5/16"	M16x1.5	241161605	3,33
3/8"	M16x1.5	241161606	3,20
3/8"	M18x1.5	241161806	4,30
1/2"	M18x1.5	241161808	4,30
1/2"	M22x1.5	241162208	6,60
5/8"	M22x1.5	241162210	4,91
3/4"	M30x2	241163012	10,92

*Hasta fin de existencias. / *Until end of stock. / *Jusqu'à la fin du stock. / *Fino ad esaurimento scorta.

Tornillo orientable simple rosca Métrica

Metric bolt for Banjo

Vis creuse simple pour banjo filetage métrique

Bullone forato Metrico

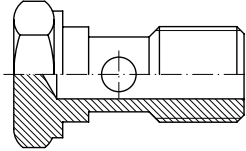

THREAD ROSCA	Part nº Referencia	€
M8x1	S109208	*
M10x1	S109210	*
M12x1.5	S109212	*
M14x1.5	S109214	*
M16x1.5	S109216	*
M18x1.5	S109218	*
M22x1.5	S109222	*
M26x1.5	S109226	*
M30x1.5	S109230	*

*Ver precios en p.292 (ADAPTADORES BSP) / *See prices in p.292 (BSP ADAPTORS) / *Prix à la p.292 (ADAPTEURS BSP) / *Vedere prezzi p.292 (ADATTATORI BSP)

Espiga lisa recta Métrica

Metric standpipe

Embout lisse droit Métrique

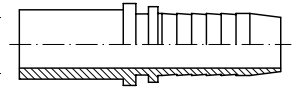

Estremità tubolare diritta Metrica

DN	PIPE TUBO	Part nº Referencia	€
1/8"	6	241580602 L	2,29
3/16"	6	241580603 L	0,95
1/4"	6	241580604 L	0,91
3/16"	8	241580803 L	1,20
1/4"	8	241580804 L	0,94
5/16"	8	241580805 L	3,71
5/16"	10	241581005 L	1,66
3/8"	10	241581006 L	1,26
3/8"	12	241581206 L	1,17
1/2"	12	241581208 L	4,72
3/8"	15	241581506 L	1,77
1/2"	15	241581508 L	1,90
1/2"	18	241581808 L	2,02
5/8"	18	241581810 L	3,49
3/4"	22	241582212 L	4,62
1"	28	241582816 L	8,17
1 1/4"	35	241583520 L	13,46
1 1/2"	42	241584224 L	17,41
1/4"	10	241581004 S	1,03
1/4"	12	241581204 S	1,76
5/16"	12	241581205 S	1,65
3/8"	14	241581406 S	2,18
1/2"	14	241581408 S	2,75
1/2"	16	241581608 S	2,53
3/4"	20	241582012 S	4,62
1"	25	241582516 S	8,65
1"	30	241583016 S	8,29

Conexiones Serie Standard

Standard series fittings
Embouts série Standard
Raccordi serie Standard

Hoses

Flexible hose fittings

Flow measuring

Equipment for flexible hoses

Hembras giratorias Métricas cono 24°/60°

Female metric swivel 24°/60° cone

Femelle tournante Métrique cône 24°-60°

Femmina Metrica Girevole Multiseal 24°/60°

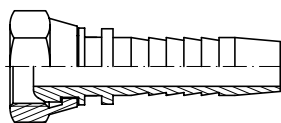

DN	PIPE TUBO	THREAD ROSCA	Part nº Referencia	€
1/4"	8L	M14X1.5	244049511	1,65
1/4"	10L	M16X1.5	244049520	1,99
5/16"	10L	M16X1.5	244049523	1,94
3/8"	10L	M16X1.5	244049524	2,43
5/16"	12L	M18X1.5	244049525	2,17
3/8"	12L	M18X1.5	244049535	2,29
3/8"	15L	M22X1.5	244049552	3,44
1/2"	15L	M22X1.5	244049555	3,85
5/8"	18L	M26X1.5	244049571	4,72

Hembras giratorias 90° Métricas cono 24°/60°

Female metric swivel 24°/60° cone (90° Elbow)

Femelle tournante coude 90° Métrique cône 24°-60°

Femmina Metrica Girevole a 90° Multiseal 24°/60°

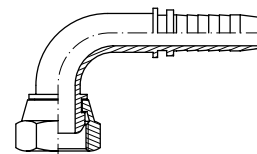

DN	PIPE TUBO	THREAD ROSCA	Part nº Referencia	€
1/4"	8L	M14X1.5	244059511	2,09
1/4"	10L	M16X1.5	244059520	2,41
5/16"	10L	M16X1.5	244059523	2,30
3/8"	10L	M16X1.5	244059524	3,07
5/16"	12L	M18X1.5	244059525	2,67
3/8"	12L	M18X1.5	244059535	2,67
3/8"	15L	M22X1.5	244059552	4,12
1/2"	15L	M22X1.5	244059555	4,83
5/8"	18L	M26X1.5	244059571	6,83

Hembras giratorias 45° Métricas cono 24°/60°

Female metric swivel 24°/60° cone (45° Elbow)

Femelle tournante coude 45° Métrique cône 24°-60°

Femmina Metrica Girevole a 45° Multiseal 24°/60°

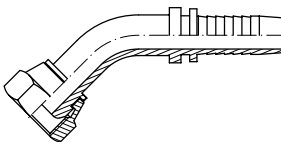

DN	PIPE TUBO	THREAD ROSCA	Part nº Referencia	€
1/4"	8L	M14X1.5	244069511	3,29
5/16"	10L	M16X1.5	244069523	3,50
3/8"	10L	M16X1.5	244069524	4,12
5/16"	12L	M18X1.5	244069525	4,12
3/8"	12L	M18X1.5	244069535	2,81
1/2"	15L	M22X1.5	244069555	5,90
5/8"	18L	M26X1.5	244069571	8,77

Hembras giratorias rectas Komatsu cono 60°

Komatsu swivel female 60° cone

Femelle tournante droite Komatsu Métrique (cône 60°)

Femmina Komatsu sede 60°

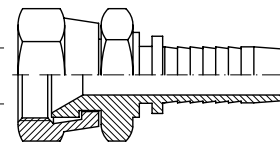

DN	THREAD ROSCA	Part nº Referencia	€
1/4"	M14X1.5	258049625	4,06
3/8"	M18X1.5	258049635	3,67
1/2"	M22X1.5	258049655	6,85
5/8"	M24X1.5	258049665	9,42
3/4"	M30X1.5	258049684	12,81
1"	M33X1.5	258049685	13,68

ROSCA MÉTRICA - ESTANQUEIDAD CONO METAL-METAL



METRIC THREAD - METAL-METAL CONE SEAL

Conexiones Serie Standard

Standard series fittings
Embouts série Standard
Raccordi serie Standard

Macho rosca cónica NPT

NPT male thread

Mâle fixe gaz conique NPT

Maschio NPT 60

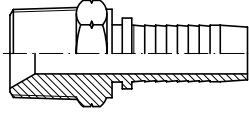

DN	THREAD ROSCA	Part nº Referencia	€
3/16"	1/8" NPT	241610203	1,66
1/4"	1/8" NPT	241610204	1,63
3/16"	1/4" NPT	241610403	1,63
1/4"	1/4" NPT	241610404	1,63
5/16"	1/4" NPT	241610405	2,47
3/8"	1/4" NPT	241610406	2,47
1/4"	3/8" NPT	241610604	2,47
5/16"	3/8" NPT	241610605	2,47
3/8"	3/8" NPT	241610606	2,16
1/2"	3/8" NPT	241610608	3,00
3/8"	1/2" NPT	241610806	3,00
1/2"	1/2" NPT	241610808	2,57
5/8"	1/2" NPT	241610810	4,28
1/2"	3/4" NPT	241611208	5,57
5/8"	3/4" NPT	241611210	4,41
3/4"	3/4" NPT	241611212	4,42
1"	3/4" NPT	241611216	8,20
3/4"	1" NPT	241611612	8,20
1"	1" NPT	241611616	8,20
1"	1"1/4 NPT	241612016	16,58
1"1/4"	1"1/4 NPT	241612020	15,33
1"1/4"	1"1/2 NPT	241612420	22,04
1"1/2"	1"1/2 NPT	241612424	22,04

Hembras giratorias NPSM

NPSM swivel female

Femelle tournante NPSM

Femmina diritta NPSM

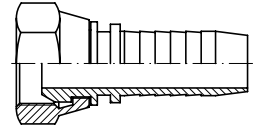

DN	THREAD ROSCA	Part nº Referencia	€
1/4"	1/4" NPSM	242610404	2,13
3/8"	3/8" NPSM	242610606	2,51
1/2"	1/2" NPSM	242610808	3,25
3/4"	3/4" NPSM	242611212	5,10
1"	1" NPSM	242611616	8,54

Macho Métrico cono 24° serie francesa

Metric stud 24° cone French Series

Mâle fixe Série Française Métrique 24°

Maschio Metrico sede 24°

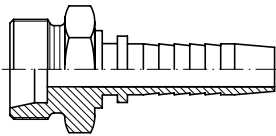

DN	PIPE TUBO	THREAD ROSCA	Part nº Referencia	€
1/4"	13.2	M20X1.5	245032013204	2,20
5/16"	13.2	M20X1.5	245032013205	2,08
3/8"	13.2	M20X1.5	245032013206	2,02
5/16"	16.7	M24X1.5	245032416705	3,30
3/8"	16.7	M24X1.5	245032416706	3,30
1/2"	16.7	M24X1.5	245032416708	3,42
5/8"	21.2	M30X1.5	245033021210	5,81
3/4"	21.2	M30X1.5	245033021212	5,50
3/4"	26.7	M36X1.5	245033626712	8,80
1"	33.5	M45X1.5	245034533516	14,31

Macho Métrico válvula agrícola

Metric stud for agricultural valve

Mâle fixe Métrique pour valve agricole

Maschio Metrico per valvola agricola

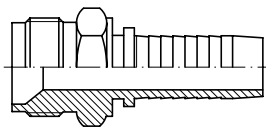

DN	THREAD ROSCA	Part nº Referencia	€
1/4"	M18X1.5	245051804	2,97
5/16"	M18X1.5	245051805	2,78
3/8"	M18X1.5	245051806	2,78

Hembra giratoria recta Métrica cono 24° serie francesa

Metric swivel female 24° cone French Series

Femelle tournante Série Française Métrique 24°

Femmina Metrica sede 24°

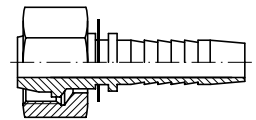

DN	PIPE TUBO	THREAD ROSCA	Part nº Referencia	€
1/4"	13.2	M20X1.5	245042013204	2,45
5/16"	13.2	M20X1.5	245042013205	2,65
3/8"	13.2	M20X1.5	245042013206	2,60
5/16"	16.7	M24X1.5	245042416705	3,71
3/8"	16.7	M24X1.5	245042416706	4,18
1/2"	16.7	M24X1.5	245042416708	4,18
5/8"	21.2	M30X1.5	245043021210	6,17
3/4"	26.7	M36X1.5	245043626712	9,53
1"	33.5	M45X1.5	245044533516	15,86

Hembra giratoria 90° Métrica cono 24° serie francesa

Metric swivel female 24° cone French Series (90° Elbow)

Femelle tournante coude 90° Série Française Métrique 24°

Femmina Metrica a 90° sede 24°

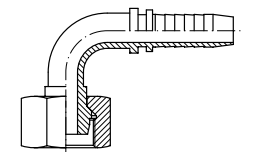

DN	PIPE TUBO	THREAD ROSCA	Part nº Referencia	€
5/16"	13.2	M20X1.5	245052013205	4,72
3/8"	13.2	M20X1.5	245052013206	5,22
1/2"	16.7	M24X1.5	245052416708	6,87
5/8"	21.2	M30X1.5	245053021210	12,86
3/4"	26.7	M36X1.5	245053626712	19,58

Conexiones Serie Standard

Standard series fittings
Embouts série Standard
Raccordi serie Standard

Hoses

Flexible hose fittings

Flow measuring

Equipment for flexible hoses

Hembra giratoria recta ORFS asiento plano

ORFS Swivel female straight flat seat

Femelle tournante -ORFS fond plat

Femmina diritta sede piana ORFS

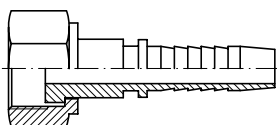

DN	THREAD ROSCA	Part nº Referencia	€
1/4"	9/16" 18h UNF	449000404	2,50
1/4"	11/16" 16h UNF	449000604	3,01
5/16"	11/16" 16h UNF	449000605	3,01
3/8"	11/16" 16h UNF	449000606	2,85
3/8"	13/16" 16h UNF	449000806	3,65
1/2"	13/16" 16h UNF	449000808	2,81
1/2"	1" 14h UNF	449001008	5,06
5/8"	1" 14h UNF	449001010	5,84
1/2"	1" 3/16 12h UNF	449001208	7,56
3/4"	1" 3/16 12h UNF	449001212	7,15
3/4"	1" 7/16 12h UNF	449001612	12,47
1"	1" 7/16 12h UNF	449001616	8,36
1"1/4	1" 11/16 12h UNF	449002020	20,49
1"1/2	2" 12h UNF	449002424	35,11

Hembra giratoria 90° ORFS asiento plano

ORFS Swivel female flat seat (90° Elbow)

Femelle tournante coude 90° -ORFS fond plat

Femmina a 90° sede piana ORFS

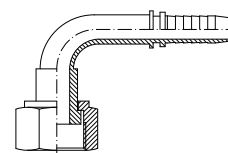

DN	THREAD ROSCA	Part nº Referencia	€
1/4"	9/16" 18h UNF	449070404	3,48
1/4"	11/16" 16h UNF	449070604	4,53
5/16"	11/16" 16h UNF	449070605	4,53
3/8"	11/16" 16h UNF	449070606	4,05
3/8"	13/16" 16h UNF	449070806	6,10
1/2"	13/16" 16h UNF	449070808	5,63
1/2"	1" 14h UNF	449071008	9,30
5/8"	1" 14h UNF	449071010	9,36
1/2"	1" 3/16-12h UNF	449071208	12,81
3/4"	1" 3/16 12h UNF	449071212	11,53
3/4"	1" 7/16 12h UNF	449071612	20,17
1"	1" 7/16 12h UNF	449071616	20,17
1"1/4	1" 11/16 12h UNF	449072020	36,55
1"1/2	2" 12h UNF	449072424	51,09

Machos ORFS asiento plano con junta tórica

ORFS Male flat seat + o´ring

Mâle fixe -ORFS fond plat + o´ring

Maschio ORFS sede piana con o´ring

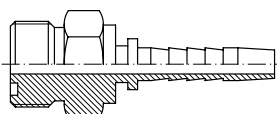

DN	THREAD ROSCA	Part nº Referencia	€
1/4"	9/16" 18h UNF	449120404	2,10
1/4"	11/16" 16h UNF	449120604	2,67
5/16"	11/16" 16h UNF	449120605	2,67
3/8"	11/16" 16h UNF	449120606	2,98
3/8"	13/16" 16h UNF	449120806	3,97
1/2"	13/16" 16h UNF	449120808	3,97
1/2"	1" 14h UNF	449121008	4,87
5/8"	1" 14h UNF	449121010	5,15
1/2"	1" 3/16 12h UNF	449121208	8,38
3/4"	1" 3/16 12h UNF	449121212	8,38
3/4"	1" 7/16 12h UNF	449121612	13,86
1"	1" 7/16 12h UNF	449121616	13,86
1"1/4	1" 11/16-12h UNF	449122020	23,36

Hembra giratoria 45° ORFS asiento plano

ORFS Swivel female (45° Elbow) flat seat

Femelle tournante coude 45° -ORFS fond plat

Femmina a 45° sede piana ORFS

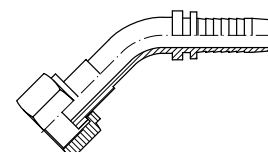

DN	THREAD ROSCA	Part nº Referencia	€
1/4"	9/16" 18h UNF	449080404	2,67
1/4"	11/16" 16h UNF	449080604	4,53
5/16"	11/16" 16h UNF	449080605	4,53
3/8"	11/16" 16h UNF	449080606	4,21
3/8"	13/16" 16h UNF	449080806	6,15
1/2"	13/16" 16h UNF	449080808	6,29
1/2"	1" 14h UNF	449081008	8,94
5/8"	1" 14h UNF	449081010	9,31
1/2"	1" 3/16 12h UNF	449081208	12,81
3/4"	1" 3/16 12h UNF	449081212	13,95
3/4"	1" 7/16 12h UNF	449081612	20,17
1"	1" 7/16 12h UNF	449081616	24,10
1"1/4	1" 11/16 12h UNF	449082020	32,54
1"1/2	2" 12h UNF	449082424	51,09

Juntas tóricas para ORFS

O´rings for ORFS

O´rings pour ORFS

O´rings per raccordi ORFS



Ø INNER Ø INT.	Thickness (mm) Espesor (mm)	Part nº Referencia	€
7,65	1,78	7.65X1.78	0,07
9,25	1,78	9.25X1.78	0,09
12,42	1,78	12.42X1.78	0,10
15,60	1,78	15.60X1.78	0,12
18,77	1,78	18.77X1.78	0,14
23,52	1,78	23.52X1.78	0,18
29,87	1,78	29.87X1.78	0,23
37,82	1,78	37.82X1.78	0,31

Conexiones Serie Standard

Standard series fittings
Embouts série Standard
Raccordi serie Standard

Brida recta SAE 3000 PSI

3000 PSI SAE Straight Flange / Code 61

Bride SAE droite série 3000 PSI

Flangia diritta SAE 3000 PSI

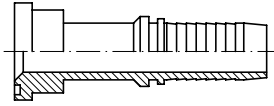

DN	Ø	Part nº Referencia	€
1/2"	30.2	241820808	6,45
1/2"	38.1	241821208	9,86
5/8"	38.1	241821210	11,18
3/4"	38.1	241821212	9,92
3/4"	44.5	241821612	16,43
1"	44.5	241821616	13,88
1"	50.8	241822016	23,93
1"1/4	50.8	241822020	19,50
1"1/4	60.3	241822420	35,89
1"1/2	60.3	241822424	37,47
1"1/2	71.4	241823224	66,81
2"	71.4	241823232	60,73

Brida recta SAE 6000 PSI

6000 PSI SAE Straight Flange / Code 62

Bride SAE droite série 6000 PSI

Flangia diritta SAE 6000 PSI

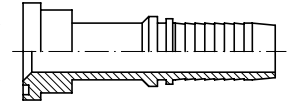

DN	Ø	Part nº Referencia	€
1/2"	31.8	242820808	7,63
1/2"	41.3	242821208	11,18
5/8"	41.3	242821210	11,84
3/4"	41.3	242821212	12,89
3/4"	47.6	242821612	18,14
1"	47.6	242821616	18,67
1"	54	242822016	24,71
1"1/4	54	242822020	26,03
1"1/4	63.5	242822420	37,87
1"1/2	63.5	242822424	40,10
1"1/2	79.4	242823224	72,66
2"	79.4	242823232	55,33

Brida a 90° SAE 3000 PSI

3000 PSI SAE Flange (90° Elbow) / Code 61

Bride SAE coude 90° série 3000 PSI

Flangia a 90° SAE 3000 PSI

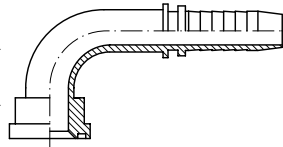

DN	Ø	Part nº Referencia	€
1/2"	30.2	241830808	8,51
1/2"	38.1	241831208	12,08
5/8"	38.1	241831210	12,38
3/4"	38.1	241831212	12,32
3/4"	44.5	241831612	18,79
1"	44.5	241831616	19,29
1"	50.8	241832016	27,19
1"1/4	50.8	241832020	28,40
1"1/4	60.3	241832420	40,85
1"1/2	60.3	241832424	42,16
1"1/2	71.4	241833224	73,53
2"	71.4	241833232	78,44

Brida a 90° SAE 6000 PSI

6000 PSI SAE Flange (90° Elbow) / Code 62

Bride SAE coude 90° série 6000 PSI

Flangia a 90° SAE 6000 PSI

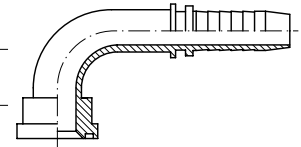

DN	Ø	Part nº Referencia	€
1/2"	31.8	242830808	9,18
1/2"	41.3	242831208	14,05
5/8"	41.3	242831210	12,60
3/4"	41.3	242831212	12,81
3/4"	47.6	242831612	20,42
1"	47.6	242831616	20,91
1"	54	242832016	29,30
1"1/4	54	242832020	30,21
1"1/4	63.5	242832420	43,79
1"1/2	63.5	242832424	45,43
1"1/2	79.4	242833224	78,44

Brida a 45° SAE 3000 PSI

3000 PSI SAE Flange (45° Elbow) / Code 61

Bride SAE coude 45° série 3000 PSI

Flangia a 45° SAE 3000 PSI

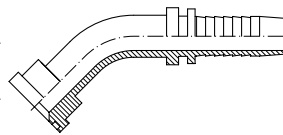

DN	Ø	Part nº Referencia	€
1/2"	30.2	241840808	8,51
1/2"	38.1	241841208	12,08
5/8"	38.1	241841210	12,38
3/4"	38.1	241841212	12,32
3/4"	44.5	241841612	18,79
1"	44.5	241841616	19,29
1"	50.8	241842016	27,19
1"1/4	50.8	241842020	28,40
1"1/4	60.3	241842420	40,85
1"1/2	60.3	241842424	42,16
1"1/2	71.4	241843224	73,53
2"	71.4	241843232	78,44

Brida a 45° SAE 6000 PSI

6000 PSI SAE Flange (45° Elbow) / Code 62

Bride SAE coude 45° série 6000 PSI

Flangia a 45° SAE 6000 PSI

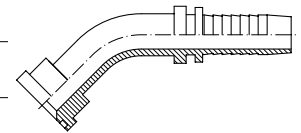

DN	Ø	Part nº Referencia	€
1/2"	31.8	242840808	9,18
1/2"	41.3	242841208	14,05
5/8"	41.3	242841210	12,60
3/4"	41.3	242841212	12,81
3/4"	47.6	242841612	20,42
1"	47.6	242841616	20,91
1"	54	242842016	29,30
1"1/4	54	242842020	30,21
1"1/4	63.5	242842420	43,79
1"1/2	63.5	242842424	45,43
1"1/2	79.4	242843224	78,44
2"	79.4	242843232	80,06

Conexiones Serie Standard

Standard series fittings
Emboutis série Standard
Raccordi serie Standard

Brida recta 9000 PSI (14,3)

9000 PSI straight Flange (14,3)

Bride tournante droite série 9000 PSI (14,3)

Flangia diritta PSI 9000 (14,3)

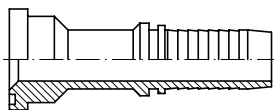

DN	Ø	Part n° Referencia	€
1/2"	41,3	442821212	13,62
3/4"	47,6	442821612	22,07
1"	47,6	442821616	22,07
1"	54	442822016	27,59
1" 1/4	54	442822020	27,59
1" 1/2	63,5	442822424	48,08

Brida a 45° 9000 PSI (14,3)

9000 PSI 45° Flange (14,3)

Bride tournante coude 45° série 9000 PSI (14,3)

Flangia a 45° PSI 9000 (14,3)

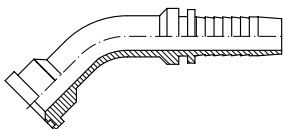

DN	Ø	Part n° Referencia	€
3/4"	41,3	442841212	17,57
3/4"	47,6	442841612	27,59
1"	47,6	442841616	27,59
1"	54	442842016	38,28
1" 1/4	54	442842020	38,28
1" 1/2	63,5	442842424	48,08

Brida a 90° 9000 PSI (14,3)

9000 PSI 90° Flange (14,3)

Bride tournante coude 90° série 9000 PSI (14,3)

Flangia a 90° PSI 9000 (14,3)

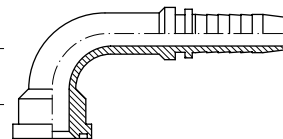

DN	Ø	Part n° Referencia	€
3/4"	41,3	442831212	17,57
3/4"	47,6	442831612	27,59
1"	47,6	442831616	27,59
1"	54	442832016	38,28
1" 1/4	54	442832020	38,28
1" 1/2	63,5	442832424	48,08

Conexiones Serie Standard

Standard series fittings
Embouts série Standard
Raccordi serie Standard

Bridas SAE partidas (semibridas) 3000/6000 PSI

3000/6000 PSI SAE Split flanges

Demi-brides rectangulaires de fixation SAE
3000/6000 PSI

Semiflanguia SAE 3000/6000 PSI

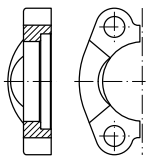

SERIE	SIZE TAMAÑO	Part nº Referencia	€
3000 PSI	1/2"	BBP308	4,90
3000 PSI	3/4"	BBP312	5,56
3000 PSI	1"	BBP316	6,09
3000 PSI	1"1/4	BBP320	7,76
3000 PSI	1"1/2	BBP324	9,80
3000 PSI	2"	BBP332	11,59
3000 PSI	2"1/2	BBP340	22,93
3000 PSI	3"	BBP348	44,88
3000 PSI	3"1/2	BBP356	51,32
3000 PSI	4"	BBP364	54,25
6000 PSI	1/2"	BBP608	5,85
6000 PSI	3/4"	BBP612	7,66
6000 PSI	1"	BBP616	11,89
6000 PSI	1"1/4	BBP620	16,74
6000 PSI	1"1/2	BBP624	24,90
6000 PSI	2"	BBP632	38,08

€/par / €/pair / €/paire / €/coppia

Tornillos para bridas SAE

Screws for SAE flanges

Vis pour bridas SAE

Vite per flangia SAE



THREAD ROSCA	SIZE TAMAÑO	Part nº Referencia	€
M8X30	3000-6000 PSI 1/2"	TB8X30	*
M10X35	3000 PSI 3/4"-1"	TB10X35	*
M10X40	3000 PSI 1" 1/4 - 6000 PSI 3/4"	TB10X40	*
M12X45	3000 PSI 1"1/2-2"-2"1/2-6000 PSI 1"	TB12X45	*
M14X45	6000 PSI 1"1/4	TB14X45	*
M16X50	3000 PSI 3"-3" 1/2-4"- 6000 PSI 1" 1/2	TB16X50	*
M20X70	6000 PSI 2"	TB20X70	*

*Ver precios en p.251 / *See prices in p.251 / *Prix à la p.251 / *Vedere prezzi p.251

Juntas para bridas SAE 3000/6000 PSI

Seals for 3000/6000 PSI flange

Joints pour bride série 3000/6000

Guarnizioni per flangia SAE 3000/6000 PSI



Ø OUTER Ø EXT.	Ø INNER Ø INT.	SIZE TAMAÑO	Part nº Referencia	€
25.40	17.02	1/2"	JBR08	0,78
31.72	23.36	3/4"	JBR12	0,95
39.62	31.24	1"	JBR16	1,20
44.45	36.07	1"1/4	JBR20	1,66
53.98	45.34	1"1/2	JBR24	1,95
63.50	54.86	2"	JBR32	2,09

Bridas SAE enteras (monoblock) 3000/6000 PSI

3000/6000 PSI SAE Flanges

Brides monobloc rectangulaires de fixation SAE
3000/6000 PSI

Flangia SAE 3000/6000 PSI

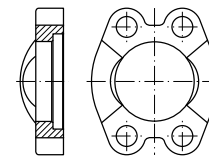

SERIE	SIZE TAMAÑO	Part nº Referencia	€
3000 PSI	1/2"	BBE308	4,90
3000 PSI	3/4"	BBE312	7,18
3000 PSI	1"	BBE316	6,09
3000 PSI	1"1/4	BBE320	7,76
3000 PSI	1"1/2	BBE324	8,91
3000 PSI	2"	BBE332	11,59
3000 PSI	2"1/2	BBE340	25,23
3000 PSI	3"	BBE348	37,51
3000 PSI	3"1/2	BBE356	51,32
3000 PSI	4"	BBE364	70,81
3000 PSI	5"	BBE380	89,77
6000 PSI	1/2"	BBE608	6,08
6000 PSI	3/4"	BBE612	9,89
6000 PSI	1"	BBE616	11,30
6000 PSI	1"1/4	BBE620	16,74
6000 PSI	1"1/2	BBE624	34,08
6000 PSI	2"	BBE632	38,08

Juntas tóricas para bridas SAE 3000/6000 PSI

O'rings for 3000/6000 PSI SAE flanges

O'rings pour bride série 3000/6000 PSI

O'rings per flangia SAE 3000/6000 PSI



Ø INNER Ø INT.	SIZE TAMAÑO	Part nº Referencia	€
18.64	1/2"	18.64X3.53	0,22
24.99	3/4"	24.99X3.53	0,29
32.92	1"	32.92X3.53	0,39
37.70	1"1/4	37.70X3.53	0,45
47.22	1"1/2	47.22X3.53	0,59
56.74	2"	56.74X3.53	0,68

Conexiones Serie Standard

Standard series fittings
Embouts série Standard
Raccordi serie Standard

Macho pistola hidrolavadora

Male terminal steel hydro-wash

Mâle fixe spécial pistolet-hydroneettoyage

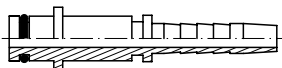

Maschio pistola idropulitrice

DN	Part n° Referencia	€
1/4"	230400400	1,49

Empuñaduras de goma negras

Handle with black rubber

Poignée hydroneettoyage de gomme noire

Manopola di gomma nera



DN	Ø OUTER Ø EXT.	Ø INNER Ø INT.	Part n° Referencia	€
1/4"	29	15,5	230600400	1,55
5/16"	35	18	230600500	1,95
3/8"	35	21	230600600	1,78

Empuñaduras de goma grises

Handle with grey rubber

Poignée hydroneettoyage de gomme grise

Manopola di gomma grigia



DN	Ø OUTER Ø EXT.	Ø INNER Ø INT.	Part n° Referencia	€
1/4"	29	15,5	230610400	2,35
5/16"	35	18	230610500	2,98
3/8"	35	22	230610600	2,63

Hembras giratorias racor CO2 W21.8

Swivel female CO2 fitting W21.8

Raccord CO2 femelle tournante W21.8

Raccordo CO2 femmina girevole W21.8

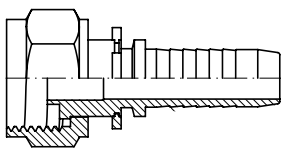

DN	THREAD ROSCA	Part n° Referencia	€
3/8"	W 21,8 1/14h	2470421806	2,87
1/2"	W 21,8 1/14h	2470421808	2,87

Terminal Karcher acero

Swivel female steel hydro-wash

Embout femelle tournante acier spécial hydroneettoyage

Femmina in acciaio per idropultrici

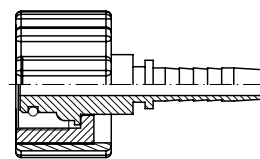

PIPE TUBO	THREAD ROSCA	DESCRIPTION DESCRIPCIÓN	Part n° Referencia	€
1/4"	M22X1.5	STD	230700400	5,09
5/16"	M22X1.5	STD	230700500	4,76
3/8"	M22X1.5	STD	230700600	4,94
1/4"	M22X1.5	Long	230720400	5,09
5/16"	M22X1.5	Long	230720500	4,76
3/8"	M22X1.5	Long	230720600	4,94

Empuñaduras de goma azules

Handle with blue rubber

Poignée hydroneettoyage de gomme bleue

Manopola di gomma azzurra



DN	Ø OUTER Ø EXT.	Ø INNER Ø INT.	Part n° Referencia	€
1/4"	29	15,5	230620400	2,41
5/16"	35	18	230620500	2,98
3/8"	35	21	230620600	2,63



Conexiones Serie Reusables

Reusable series fittings
Embouts Récuperables
Raccordi serie Recuperabile

Casquillos R1AT

Ferrules R1AT

Jupes à visser R1AT

Boccola R1AT

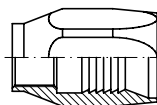

DN	Part n° Referencia	€
1/4"	A1G-4 R1T	5,89
3/8"	A1G-6 R1T	6,52
1/2"	A1G-8 R1T	9,01
3/4"	A1G-12 R1T	14,23
1"	A1G-16 R1T	23,34

Casquillos R2AT

Ferrules R2AT

Jupes à visser R2AT

Boccola R2AT

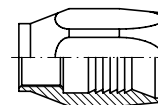

DN	Part n° Referencia	€
1/4"	A1G-4 R2T	5,01
3/8"	A1G-6 R2T	5,58
1/2"	A1G-8 R2T	7,55
5/8"	A1G-10 R2T	15,33
3/4"	A1G-12 R2T	8,60
1"	A1G-16 R2T	*

Hembras giratorias rectas BSP cono 60°

BSP Swivel female 60° cone

Femelle tournante gaz cyl BSP 60°

Femmina diritta recuperabile BSP sede 60°

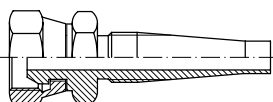

DN	THREAD ROSCA	Part n° Referencia	€
1/4"	1/4" BSP	A3G-4	3,78
5/16"	3/8" BSP	A3G-6-5	4,66
3/8"	3/8" BSP	A3G-6	4,90
1/2"	1/2" BSP	A3G-8	8,42
3/4"	3/4" BSP	A3G-12	9,48
1"	1" BSP	A3G-16	17,39

Espigas lisas Métricas

Metric Standpipe

Embout lisse Métrique

Estremità tubolare Metrica recuperabile

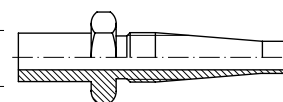

DN	PIPE TUBO	Part n° Referencia	€
1/4"	6	AE 6-4	3,25
1/4"	8	AE 8-4	3,25
1/4"	10	AE 10-4	3,25
3/8"	10	AE 10-6	4,46
3/8"	12	AE 12-6	4,46
1/2"	15	AE 15-8	8,05
3/4"	22	AE 22-12	25,68

Hembras giratorias 90° BSP cono 60°

BSP Swept 90° elbow 60° cone

Femelle tournante coude 90° gaz cyl BSP 60°

Femmina a 90° recuperabile BSP sede 60°

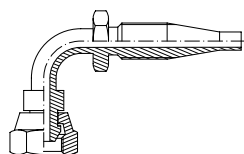

DN	THREAD ROSCA	Part n° Referencia	€
1/4"	1/4" BSP	A90G-4	5,30
3/8"	3/8" BSP	A90G-6	6,63
3/8"	1/2" BSP	A90G-8-6	10,62
1/2"	1/2" BSP	A90G-8	9,89
1/2"	3/4" BSP	A90G-12-8	15,37
3/4"	3/4" BSP	A90G-12	15,70
1"	1" BSP	A90G-16	29,06

Hembras giratorias rectas reusables rosca JIC cono 37°

Reusable JIC 37° straight swivel female

Femelle droite récupérable JIC 37°

Femmina diritta JIC sede 37° recuperabile

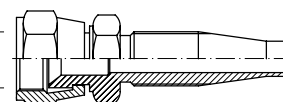

DN	THREAD ROSCA	Part n° Referencia	€
1/4"	7/16" 20h JIC	A3J-07-04	4,68
3/8"	9/16" 18h JIC	A3J-09-06	4,77
1/2"	3/4" 16h JIC	A3J-12-08	8,38
1/2"	7/8" 14h JIC	A3J-14-08	6,56
5/8"	7/8" 14h JIC	A3J-14-10	8,72
3/4"	1"1/16 12h JIC	A3J-17-12	12,26
1"	1"5/16 12h JIC	A3J-21-16	20,09

Machos rosca cilíndrica BSP cono 60°

BSP Male parallel 60° cone

Mâle gaz cyl BSP 60°

Maschio cilindrico recuperabile BSP sede 60°

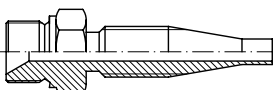

DN	THREAD ROSCA	Part n° Referencia	€
1/4"	1/4" BSP	A2G-4	2,93
5/16"	3/8" BSP	A2G-6-5	5,16
3/8"	3/8" BSP	A2G-6	4,28
3/8"	1/2" BSP	A2G-8-6	7,16
1/2"	1/2" BSP	A2G-8	5,97
1/2"	3/4" BSP	A2G-12-8	11,77
3/4"	3/4" BSP	A2G-12	8,16
1"	1" BSP	A2G-16	15,00

Machos reusables rosca JIC cono 37°

Reusable JIC 37° cone male

Mâle récupérables JIC cône 37°

Maschio JIC 37° recuperabile

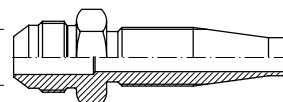

DN	THREAD ROSCA	Part n° Referencia	€
1/4"	7/16" 20h JIC	A2J-07-04	*
3/8"	9/16" 18h JIC	A2J-09-06	*
1/2"	3/4" 16h JIC	A2J-12-08	*
1/2"	7/8" 14h JIC	A2J-14-08	*
5/8"	7/8" 14h JIC	A2J-14-10	*
3/4"	1"1/16 12h JIC	A2J-17-12	*
1"	1"5/16 12h JIC	A2J-21-16	*

Conexiones Serie BW no pelar R12 / 4SP / 4SH

BW fittings - no skiving R12 / 4SP / 4SH

Embouts BW sans dénuder R12 / 4SP / 4SH

Raccordi BW - senza pelatura R12 / 4SP / 4SH

Casquillos R12/ 4SP/ 4SH serie BW

Ferrules R12/4SP/4SH BW series

Jupes à sertir R12/4SP/4SH série BW

Boccole pressare R12/4SP/4SH serie BW

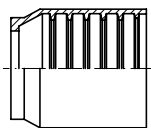

DN	Part n° Referencia	€
3/4"	AC680101200	10,68
1"	AC680101600	13,26
1" 1/4	AC680102000	22,09

Hembras giratorias rectas BSP cono 60° con junta

BSP Swivel female 60° cone with o'ring

Femelle tournante gaz cyl BSP 60° avec joint

Femmina diritta BSP sede 60° con o'ring

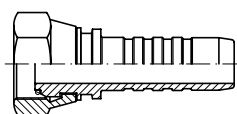

DN	THREAD ROSCA	Part n° Referencia	€
3/4"	3/4" BSP	661101212	5,96
1"	1" BSP	661101616	9,91
1" 1/4	1" 1/4 BSP	661102020	18,79

Hembras giratorias 90° BSP cono 60° con junta

BSP Swivel female 60° cone with joint (90° Elbow)

Coude 90° femelle tournante gaz cyl BSP 60° avec joint

Femmina a 90° BSP sede 60° con o'ring

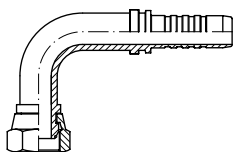

DN	THREAD ROSCA	Part n° Referencia	€
3/4"	3/4" BSP	661171212	11,82
1"	1" BSP	661171616	17,83
1" 1/4	1" 1/4 BSP	661172020	31,19

Macho JIC 37°

JIC 37° male

Mâle JIC 37°

Maschio JIC 37°

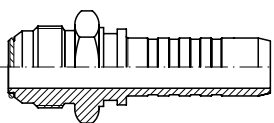

DN	THREAD ROSCA	Part n° Referencia	€
3/4"	1" 1/16 12h UNF	661401712	5,47
1"	1" 5/16 12h UNF	661402116	10,03

Hembras giratorias rectas JIC 37° doble hexagonal

JIC 37° Swivel female doble hexagonal

Femelle JIC 37° double hexagonale

Femmina diritta JIC 37° doppio esagono

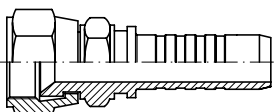

DN	THREAD ROSCA	Part n° Referencia	€
3/4"	1" 1/16 12h UNF	662421712	7,62
1"	1" 5/16 12h UNF	662422116	12,59

Hembras giratorias 45° BSP cono 60° con junta

BSP Swivel female 60° cone with joint (45° Elbow)

Coude 45° femelle tournante gaz cyl BSP 60° avec joint

Femmina a 45° BSP sede 60° con o'ring

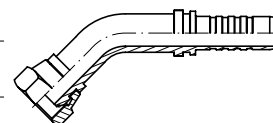

DN	THREAD ROSCA	Part n° Referencia	€
3/4"	3/4" BSP	661181212	11,86
1"	1" BSP	661181616	18,76
1" 1/4	1" 1/4 BSP	661182020	34,06

Macho BSP cono 60°

BSP Male 60° cone

Mâle BSP cône 60°

Maschio BSP 60°

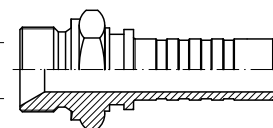

DN	THREAD ROSCA	Part n° Referencia	€
3/4"	3/4" BSP	661121212	6,84
1"	1" BSP	661121616	10,95
1" 1/4	1" 1/4 BSP	661122020	19,54

Hembras giratorias 90° JIC 37°

JIC 37° swivel female (90° Elbow)

Coude 90° femelle JIC 37°

Femmina gir. 90° JIC 37°

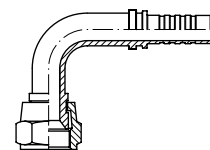

DN	THREAD ROSCA	Part n° Referencia	€
3/4"	1" 1/16 12h UNF	661381712	13,23
1"	1" 5/16 12h UNF	661382116	18,76

Hembras giratorias 45° JIC 37°

JIC 37° swivel female (45° Elbow)

Coude 45° femelle JIC 37°

Femmina gir. 45° JIC 37°

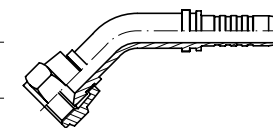

DN	THREAD ROSCA	Part n° Referencia	€
3/4"	1" 1/16 12h UNF	661391712	12,00
1"	1" 5/16 12h UNF	661392116	18,76

Conexiones Serie BW no pelar R12 / 4SP / 4SH

BW fittings - no skiving R12 / 4SP / 4SH

Embouts BW sans dénuder R12 / 4SP / 4SH

Raccordi BW - senza pelatura R12 / 4SP / 4SH

Hembras giratorias Métricas cono 24° con junta tórica

Metric swivel female 24° seat with o'ring

Femelle Métrique 24° avec o'ring

Femmina Metrica sede 24° con o'ring

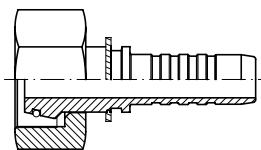

DN	THREAD ROSCA	Part n° Referencia	€
3/4"	M36X2	66204362512	11,40
1"	M42X2	66204423016	18,79
1"1/4	M52X2	66204523820	24,20

Hembras giratorias 45° Métricas cono 24° con junta tórica

Metric swivel female 24° seat with o'ring (45° Elbow)

Coude 45° femelle Métrique 24° avec o'ring

Femmina Metrica 45° sede 24° con o'ring

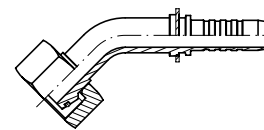

DN	THREAD ROSCA	Part n° Referencia	€
3/4"	M36X2	66206362512	15,96
1"	M42X2	66206423016	21,89
1"1/4	M52X2	66206523820	41,69

Hembras giratorias 90° Métricas cono 24° con junta tórica

Metric swivel female 24° seat with o'ring (90° Elbow)

Coude 90° femelle Métrique 24° avec o'ring

Femmina Metrica 90° sede 24° con o'ring

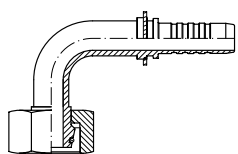

DN	THREAD ROSCA	Part n° Referencia	€
3/4"	M36X2	66205362512	17,09
1"	M42X2	66205423016	25,02
1"1/4	M52X2	66205523820	41,69

Machos fijos Métricos cono 24°

Metric male stud 24° cone

Mâle Métrique cone 24°

Maschio Metrico sede 24° con o'ring

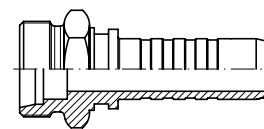

DN	THREAD ROSCA	Part n° Referencia	€
3/4"	M36X2	66203362512	10,03
1"	M42X2	66203423016	14,59

Brida recta SAE 3000 PSI

3000 PSI SAE Straight flange

Bride SAE droite série 3000 PSI

Flangia diritta SAE 3000

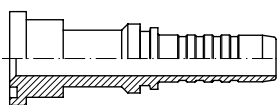

DN	Ø	Part n° Referencia	€
3/4"	38,1	661821212	11,26
1"	44,5	661821616	15,27
1"1/4	50,8	661822020	25,34

Brida recta SAE 6000 PSI

6000 PSI SAE Straight flange

Bride SAE droite série 6000 PSI

Flangia diritta SAE 6000

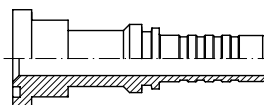

DN	Ø	Part n° Referencia	€
3/4"	41,3	662821212	12,61
1"	47,63	662821616	16,86
1"1/4	53,98	662822020	27,41

Brida a 90° SAE 3000 PSI

3000 PSI SAE 90° Flange

Bride SAE coude 90° série 3000 PSI

Flangia 90° SAE 3000

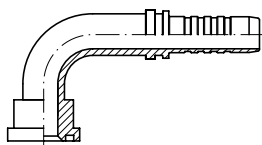

DN	Ø	Part n° Referencia	€
3/4"	38,1	661831212	17,07
1"	44,5	661831616	21,74
1"1/4	50,8	661832020	36,72

Brida a 90° SAE 6000 PSI

6000 PSI SAE 90° Flange

Bride SAE coude 90° série 6000 PSI

Flangia 90° SAE 6000

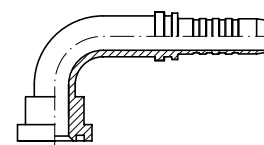

DN	Ø	Part n° Referencia	€
3/4"	41,3	662831212	18,72
1"	47,6	662831616	25,76
1"1/4	54	662832020	42,95

Brida a 45° SAE 3000 PSI

3000 PSI SAE 45° Flange

Bride SAE coude 45° série 3000 PSI

Flangia 45° SAE 3000

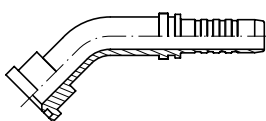

DN	Ø	Part n° Referencia	€
3/4"	38,1	661841212	17,06
1"	44,5	661841616	23,32
1"1/4	50,8	661842020	36,72

Brida a 45° SAE 6000 PSI

6000 PSI SAE 45° flange

Bride SAE coude 45° série 6000 PSI

Flangia 45° SAE 6000

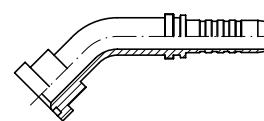

DN	Ø	Part n° Referencia	€
3/4"	41,3	662841212	18,72
1"	47,6	662841616	25,76
1"1/4	54	662842020	43,36

Conexiones Serie BW no pelar R12 / 4SP / 4SH

BW fittings - no skiving R12 / 4SP / 4SH

Embouts BW sans dénuder R12 / 4SP / 4SH

Raccordi BW - senza pelatura R12 / 4SP / 4SH

Hoses

Flexible hose fittings

Flow measuring

Equipment for flexible hoses

Hembra giratoria recta ORFS asiento plano doble hexagonal

ORFS Swivel female straight double hexagonal

Femelle droite ORFS double hexagonale

Femmina diritta ORFS doppio esagono

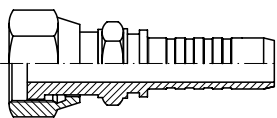

PIPE TUBO	THREAD ROSCA	Part n° Referencia	€
3/4"	1"3/16 12h UNF	669011212	8,58
1"	1"7/16 12h UNF	669011616	13,09

Hembra giratoria 90° ORFS asiento plano

ORFS Swivel female (90° Elbow)

Coude 90° femelle ORFS

Femmina 90° ORFS

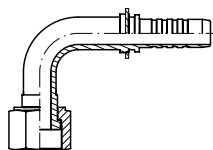

PIPE TUBO	THREAD ROSCA	Part n° Referencia	€
3/4"	1"3/16 12h UNF	669071212	14,50
1"	1"7/16 12h UNF	669071616	22,41

Hembra giratoria 45° ORFS asiento plano

ORFS Swivel female (45° Elbow)

Coude 45° femelle ORFS

Femmina 45° ORFS

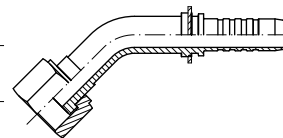

PIPE TUBO	THREAD ROSCA	Part n° Referencia	€
3/4"	1"3/16 12h UNF	669081212	12,55
1"	1"7/16 12h UNF	669081616	18,76

Conexiones Serie Interlock

Interlock series fittings
Embouts à sertir Interlock
Raccordi serie Interlock

Casquillos 4SH

Ferrules DIN 20023-4SH

Jupe à sertir DIN 20023 4SH

Boccola Interlock 4SH

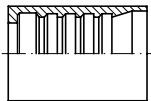

DN	DESCRIPTION DESCRIPCIÓN	Part nº Referencia	€
3/4"	4SH / R13 / R15	A610101200	7,93
1"	4SH / R13 / R15	A610101600	14,63
1"1/4	4SH	A610102000	20,60
1"1/2	4SH	A610102400	26,00
2"	4SH	A610103200	47,28

Casquillos R13-R15

Ferrules SAE 100 R13/R15

Jupe à sertir DIN 20023 R13/R15

Boccola Interlock R13/R15

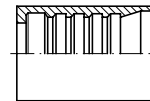

DN	DESCRIPTION DESCRIPCIÓN	Part nº Referencia	€
1"1/4	R13/R15	610102000	22,96
1"1/2	R13/R15	610102400	33,43
2"	R13/R15	610103200	54,71

Hembras giratorias rectas BSP cono 60° con junta

BSP Swivel female 60° cone + o'ring

Femelle tournante gaz cyl BSP 60° + o'ring

Femmina diritta BSP sede 60° con o'ring

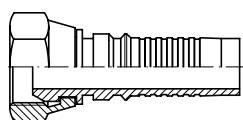

DN	THREAD ROSCA	Part nº Referencia	€
3/4"	3/4" BSP	641001212	6,62
1"	1" BSP	641001616	12,00
1"1/4	1"1/4 BSP	641002020	17,96
1"1/2	1"1/2 BSP	641002424	34,75
2"	2" BSP	641003232	55,27

Macho rosca cilíndrica BSP cono 60°

BSP Male 60° cone

Mâle fixe gaz cyl BSP 60°

Maschio cilindrico BSP sede 60°

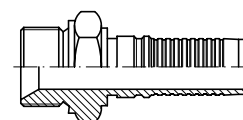

DN	THREAD ROSCA	Part nº Referencia	€
3/4"	3/4" BSP	641121212	7,05
1"	1" BSP	641121616	16,07
1"1/4	1"1/4 BSP	641122020	17,96
1"1/2	1"1/2 BSP	641122424	39,04
2"	2" BSP	641123232	56,58

Hembras giratorias 90° BSP cono 60° con junta

BSP Swivel female 60° cone + o'ring (90° Elbow)

Femelle tournante coude 90° gaz cyl BSP 60° + o'ring

Femmina a 90° BSP sede 60° con o'ring

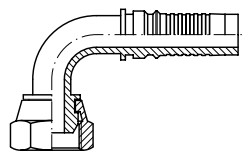

DN	THREAD ROSCA	Part nº Referencia	€
3/4"	3/4" BSP	641071212	11,12
1"	1" BSP	641071616	20,90
1"1/4	1"1/4 BSP	641072020	33,13
1"1/2	1"1/2 BSP	641072424	58,56
2"	2" BSP	641073232	84,97

Macho rosca NPT

NPT Male

Mâle fixe NPT

Maschio conico NPT

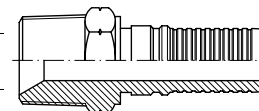

DN	THREAD ROSCA	Part nº Referencia	€
3/4"	3/4" NPT	641611212	6,59
1"	1" NPT	641611616	11,82
1"1/4	1"1/4 NPT	641612020	20,94
1"1/2	1"1/2 NPT	641612424	34,80
2"	2" NPT	641613232	50,50

Hembras giratorias 45° BSP cono 60° con junta

BSP Swivel female 60° cone + o'ring (45° Elbow)

Femelle tournante coude 45° gaz cyl BSP 60° + o'ring

Femmina a 45° BSP sede 60° con o'ring

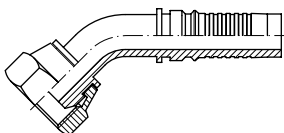

DN	THREAD ROSCA	Part nº Referencia	€
3/4"	3/4" BSP	641081212	13,48
1"	1" BSP	641081616	25,99
1"1/4	1"1/4 BSP	641082020	34,59
1"1/2	1"1/2 BSP	641082424	53,99
2"	2" BSP	641083232	84,97

Conexiones Serie Interlock

Interlock series fittings
Embouts à sertir Interlock
Raccordi serie Interlock

Hembras giratorias rectas JIC 37°

JIC 37° Swivel female

Femelle tournante JIC 37°

Femmina diritta JIC 37°

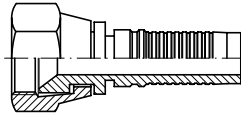

DN	THREAD ROSCA	Part nº Referencia	€
3/4"	1"1/16 12h UNF	641421712	5,86
1"	1"5/16 12h UNF	641422116	12,00
1"1/4	1"5/8 12h UNF	641422620	17,18
1"1/2	1"7/8 12h UNF	641423024	31,65
2"	2"1/2 12h UNF	641424032	60,65

Hembras giratorias 45° JIC 37°

JIC 37° Swivel female (45° Elbow)

Femelle tournante coude 45° JIC 37°

Femmina a 45° JIC 37°

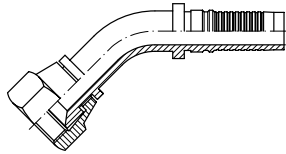

DN	THREAD ROSCA	Part nº Referencia	€
3/4"	1"1/16 12h UNF	641391712	13,48
1"	1"5/16 12h UNF	641392116	22,71
1"1/4	1"5/8 12h UNF	641392620	37,21
1"1/2	1"7/8 12h UNF	641393024	52,17
2"	2"1/2 12h UNF	641394032	97,04

Hembra giratoria recta Métrica cono 24° con junta tórica

Metric swivel female 24° seat with o'ring

Femelle tournante Métrique 24° + o'ring

Femmina Metrica sede 24° con o'ring

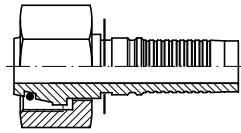

DN	PIPE TUBO	SERIE	THREAD ROSCA	Part nº Referencia	€
3/4"	20	S	M30X2	64204302012	8,44
3/4"	25	S	M36X2	64204362512	9,08
1"	30	S	M42X2	64204423016	18,91
1"1/4	38	S	M52X2	64204523820	27,41

Hembra giratoria 45° Métrica cono 24° con junta tórica

Metric swivel female 24° seat with o'ring (45° Elbow)

Femelle tournante coude 45° Métrique + o'ring

Femmina a 45° sede 24° con o'ring

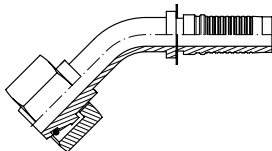

DN	PIPE TUBO	SERIE	THREAD ROSCA	Part nº Referencia	€
3/4"	20	S	M30X2	64206302012	14,96
1"	30	S	M42X2	64206423016	23,41
1"1/4	38	S	M52X2	64206523820	47,70

Hembras giratorias 90° JIC 37°

JIC 37° Swivel female (90° Elbow)

Femelle tournante coude 90° JIC 37°

Femmina a 90° JIC 37°

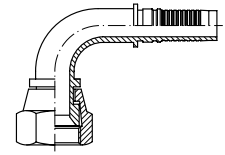

DN	THREAD ROSCA	Part nº Referencia	€
3/4"	1"1/16 12h UNF	641381712	13,90
1"	1"5/16 12h UNF	641382116	24,17
1"1/4	1"5/8 12h UNF	641382620	26,31
1"1/2	1"7/8 12h UNF	641383024	52,17
2"	2"1/2 12h UNF	641384032	84,46

Macho JIC 37°

JIC 37° male

Mâle fixe JIC 37°

Maschio JIC 37°

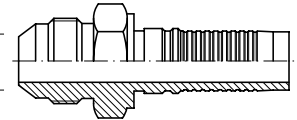

DN	THREAD ROSCA	Part nº Referencia	€
3/4"	1"1/16 12h UNF	641401712	7,62
1"	1"5/16 12h UNF	641402116	12,40
1"1/4	1"5/8 12h UNF	641402620	20,48
1"1/2	1"7/8 12h UNF	641403024	33,16
2"	2"1/2 12h UNF	641404032	55,27

Hembra giratoria 90° Métrica cono 24° con junta tórica

Metric swivel female 24° seat with o'ring (90° Elbow)

Femelle tournante coude 90° Métrique + o'ring

Femmina a 90° Metrica sede 24° con o'ring

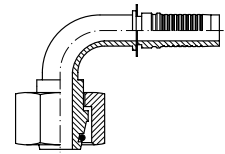

DN	PIPE TUBO	SERIE	THREAD ROSCA	Part nº Referencia	€
3/4"	20	S	M30X2	64205302012	15,41
3/4"	25	S	M36X2	64205362512	20,52
1"	30	S	M42X2	64205423016	22,16
1"1/4	38	S	M52X2	64205523820	41,50

Macho rosca Métrica cono 24°

Metric male stud 24° cone

Mâle fixe Métrique 24° série lourde

Maschio Metrico sede 24°

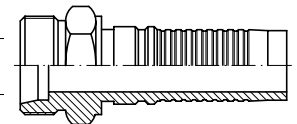

DN	PIPE TUBO	SERIE	THREAD ROSCA	Part nº Referencia	€
3/4"	20	S	M30X2	64203302012	7,89
3/4"	25	S	M36X2	64203362512	11,47
1"	30	S	M42X2	64203423016	18,72
1"1/4	38	S	M52X2	64203523820	27,36

Conexiones Serie Interlock

Interlock series fittings
Embouts à sertir Interlock
Raccordi serie Interlock

Hembra giratoria recta Métrica cono 24° C/J martillos

Metric swivel female 24° seat with o'ring for hammer

Femelle tournante Métrique 24° + o'ring pour marteau

Femmina Metrica sede 24° con o'ring per martello

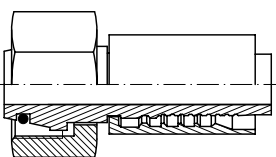

DN	PIPE TUBO	SERIE	THREAD ROSCA	Part nº Referencia	€
3/4"	25	S	M36X2	NAM362512	52,03
1"	30	S	M42X2	NAM423016	62,37
1"1/4	38	S	M52X2	NAM523820	72,28

Se venden con casquillo Interlock incluido (mismo diámetro de prensado que los casquillos A61010...) / With Interlock ferrule included (same crimping diameter as ferrule A61010) / Avec jupe Interlock incluse (même diamètre de sertissage que la jupe A61010) / Con boccola Interlock inclusa (diametro di pressatura uguale alla boccola A61010)

Hembras rectas ORFS

ORFS Swivel female

Femelle droite ORFS

Femmina diritta ORFS Interlock

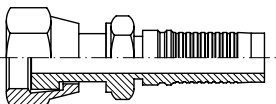

PIPE TUBO	THREAD ROSCA	Part nº Referencia	€
3/4"	1"3/16 12h UNF	649001212	9,94
1"	1"7/16 12h UNF	649001616	12,37
1"1/4	1"11/16 12h UNF	649002020	25,08
1"1/2	2" 12h UNF	649002424	29,80

Codos 45° ORFS

ORFS Swivel female (45° Elbow)

Coude 45° femelle ORFS

Curva a 45° ORFS Interlock

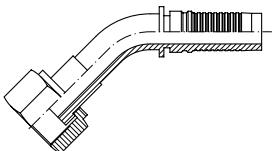

PIPE TUBO	THREAD ROSCA	Part nº Referencia	€
3/4"	1"3/16 12h UNF	649081212	14,32
1"	1"7/16 12h UNF	649081616	24,54
1"1/4	1"11/16 12h UNF	649082020	37,21

Codos 90° ORFS

ORFS Swivel female (90° Elbow)

Coude 90° femelle ORFS

Curva a 90° ORFS Interlock

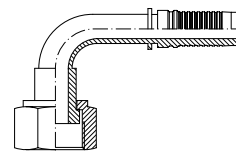

PIPE TUBO	THREAD ROSCA	Part nº Referencia	€
3/4"	1"3/16 12h UNF	649071212	15,41
1"	1"7/16 12h UNF	649071616	24,54
1"1/4	1"11/16 12h UNF	649072020	32,20
1"1/2	2" 12h UNF	649072424	46,28

Conexiones Serie Interlock

Interlock series fittings
Embouts à sertir Interlock
Raccordi serie Interlock

Hoses

Flexible hose fittings

Flow measuring

Equipment for flexible hoses

Brida SAE 3000 PSI

3000 PSI SAE Straight Flange / Code 61

Bride SAE droite série 3000 PSI

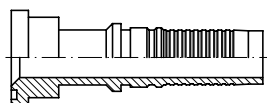

Flangia SAE 3000 PSI

DN	Ø	Part n° Referencia	€
3/4"	38.1	641821212	11,32
3/4"	44.5	641821612	15,55
1"	44.5	641821616	17,34
1"	50.8	641822016	21,79
1"1/4	50.8	641822020	26,03
1"1/4	60.3	641822420	37,89
1"1/2	60.3	641822424	44,96
2"	71.4	641823232	71,02

Brida SAE 6000 PSI

6000 PSI SAE Straight Flange / Code 62

Bride SAE droite série 6000 PSI

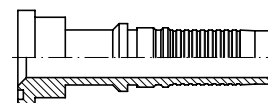

Flangia SAE 6000 PSI

DN	Ø	Part n° Referencia	€
3/4"	41,3	642821212	10,51
3/4"	47,63	642821612	15,05
1"	47,63	642821616	19,02
1"	53,98	642822016	22,73
1"1/4	53,98	642822020	29,98
1"1/4	63,5	642822420	46,22
1"1/2	63,5	642822424	42,46
2"	79,4	642823232	122,99

Brida a 90° SAE 3000 PSI

3000 PSI SAE Flange (90° Elbow) / Code 61

Bride SAE coude 90° série 3000 PSI

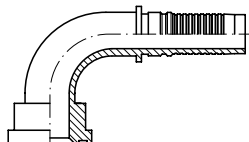

Flangia a 90° SAE 3000 PSI

DN	Ø	Part n° Referencia	€
3/4"	38.1	641831212	17,06
3/4"	44.5	641831612	23,30
1"	44.5	641831616	21,32
1"	50.8	641832016	32,96
1"1/4	50.8	641832020	32,49
1"1/4	60.3	641832420	51,25
1"1/2	60.3	641832424	58,34
2"	71.4	641833232	104,49

Brida a 90° SAE 6000 PSI

6000 PSI SAE Flange (90° Elbow) / Code 62

Bride SAE coude 90° série 6000 PSI

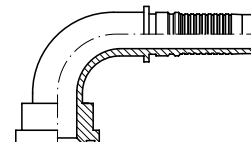

Flangia a 90° SAE 6000 PSI

DN	Ø	Part n° Referencia	€
3/4"	41.3	642831212	17,02
3/4"	47.6	642831612	25,26
1"	47.6	642831616	26,92
1"	54	642832016	40,07
1"1/4	54	642832020	35,65
1"1/4	63.5	642832420	61,27
1"1/2	63.5	642832424	77,20
2"	79.4	642833232	179,00

Brida a 45° SAE 3000 PSI

3000 PSI SAE Flange (45° Elbow) / Code 61

Bride SAE coude 45° série 3000 PSI

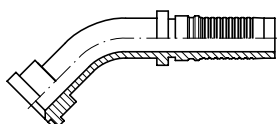

Flangia a 45° SAE 3000 PSI

DN	Ø	Part n° Referencia	€
3/4"	38.1	641841212	17,07
3/4"	44.5	641841612	23,33
1"	44.5	641841616	25,63
1"1/4	50.8	641842020	38,42
1"1/4	60.3	641842420	51,59
1"1/2	60.3	641842424	53,56
2"	71.4	641843232	122,43

Brida a 45° SAE 6000 PSI

6000 PSI SAE Flange (45° Elbow) / Code 62

Bride SAE coude 45° série 6000 PSI

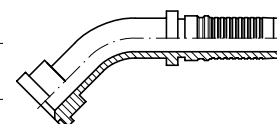

Flangia a 45° SAE 6000 PSI

DN	Ø	Part n° Referencia	€
3/4"	41,3	642841212	17,02
3/4"	47,6	642841612	26,97
1"	47,6	642841616	29,20
1"	54	642842016	40,44
1"1/4	54	642842020	38,96
1"1/2	63,5	642842424	67,17
2"	79,4	642843232	144,40

Conexiones Serie Interlock

Interlock series fittings
Embouts à sertir Interlock
Raccordi serie Interlock

Brida 9000 PSI (14,3)

9000 PSI Straight flange (14,3)

Bride droite série 9000 PSI (14,3)

Flangia 9000 PSI (14,3)

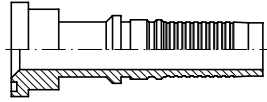

DN	Ø	Part nº Referencia	€
3/4"	41,3	643821212	15,76
1"	47,6	643821616	23,20
1"	54	643822016	31,35
1"1/4	54	643822020	29,86
1"1/4	63,5	643822420	47,20
1"1/2	63,5	643822424	43,50

Brida a 45° 9000 PSI (14,3)

45° 9000 PSI Flange (14,3)

Bride coude 45° série 9000 PSI (14,3)

Flangia a 45° 9000 PSI (14,3)

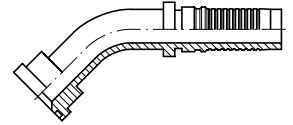

DN	Ø	Part nº Referencia	€
3/4"	41,3	643841212	18,63
1"	47,6	643841616	30,72
1"	54	643842016	41,64
1"1/4	54	643842020	43,80
1"1/2	63,5	643842424	71,56

Brida a 90° 9000 PSI (14,3)

90° 9000 PSI Flange (14,3)

Bride coude 90° série 9000 PSI (14,3)

Flangia a 90° 9000 PSI (14,3)

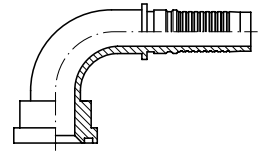

DN	Ø	Part nº Referencia	€
3/4"	41,3	643831212	20,35
1"	47,6	643831616	34,84
1"	54	643832016	58,76
1"1/4	54	643832020	62,07
1"1/2	63,5	643832424	82,13

Conexiones Serie Interlock

Interlock series fittings
Embouts à sertir Interlock
Raccordi serie Interlock

Hoses

Flexible hose fittings

Flow measuring

Equipment for flexible hoses

Espiga para brida macho Poclairn

Poclairn male flange

Embout bride mâle Poclairn

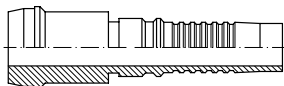

Inserto per flangia maschio Poclairn 4SH

DN	Ø	Part nº Referencia	€
3/4"	3/4"	648011212	14,77
1"	1"	648011616	36,54
1"1/4	1"1/4	648012020	46,93

Hasta fin de existencias. / Until end of stock. / Jusqu'à la fin du stock. / Fino ad esaurimento scorta.

Espiga para brida hembra Poclairn

Poclairn female flange

Embout bride femelle Poclairn

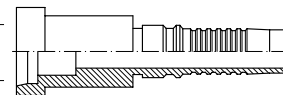

Inserto per flangia femmina Poclairn 4SH

DN	Ø	Part nº Referencia	€
3/4"	3/4"	648021212	28,41
1"	1"	648021616	29,33
1"1/4	1"1/4	648022020	43,26

Hasta fin de existencias. / Until end of stock. / Jusqu'à la fin du stock. / Fino ad esaurimento scorta.

Brida entera macho Poclairn 4 agujeros

Male Poclairn flange 4 holes

Bride rectangulaire de fixation mâle Poclairn-4 trous

Flangia intera maschio Poclairn 4 fori

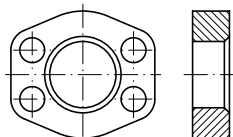

SIZE TAMAÑO	Part nº Referencia	€
3/4"	448051212	35,98
1"	448051616	42,90
1"1/4	448052020	56,99

Hasta fin de existencias. / Until end of stock. / Jusqu'à la fin du stock. / Fino ad esaurimento scorta.

Brida entera hembra Poclairn 4 agujeros

Female Poclairn flange 4 holes

Bride rectangulaire de fixation femelle Poclairn-4 trous

Flangia intera femmina Poclairn 4 fori

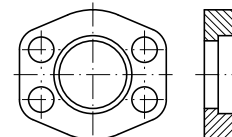

SIZE TAMAÑO	Part nº Referencia	€
3/4"	448061212	51,41
1"	448061616	58,47
1"1/4	448062020	72,97

Hasta fin de existencias. / Until end of stock. / Jusqu'à la fin du stock. / Fino ad esaurimento scorta.

Brida entera macho Poclairn 2 agujeros

Male Poclairn flange 2 holes

Bride ovale fixation mâle Poclairn 2 trous

Flangia intera maschio Poclairn 2 fori

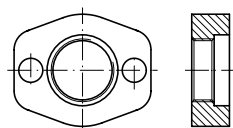

PIPE TUBO	Part nº Referencia	€
5/8"	448071010	29,92
3/4"	448071212	29,33
1"	448071616	35,76
1"1/4	448072020	56,96

Hasta fin de existencias. / Until end of stock. / Jusqu'à la fin du stock. / Fino ad esaurimento scorta.

Conexiones Alta presión (700 Bar)

High pressure 700 Bar fittings

Embouts haute pression 700 Bar

Raccordi altissima pressione (700 Bar)

Manguera termoplástica 700 bar

Thermoplastic hose 700 bar

Tuyau thermoplastique haute pression 700 bar



Tube termoplastico 700 bar

DN	Part n° Referencia	€
1/4"	MT70004	23,10
3/8"	MT70006	54,44

Casquillos manguera 700 bar tipo MT700

Ferrules for thermoplastic hose 700 bar MT700 type

Jupes à sertir thermoplastique 700 bar type MT700

Boccole per tubo termoplastico 700 bar tipo MT700

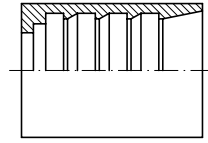

DN	Part n° Referencia	€
1/4"	710120400	2,04
3/8"	710120600	2,90

Hembra giratoria recta BSP 60°

BSP Swivel female 60° cone

Embout thermoplastique 700 bar femelle tournante gaz cyl BSP 60°

Femmina diritta BSP sede 60°

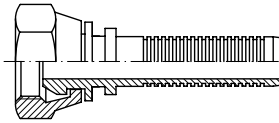

DN	THREAD ROSCA	Part n° Referencia	€
1/4"	1/4" BSP	741000404	5,01
3/8"	3/8" BSP	741000606	4,01

Macho BSP 60°

BSP Male parallel 60° cone

Embout thermoplastique 700 bar mâle fixe gaz cyl BSP 60°

Maschio cilindrico BSP sede 60°

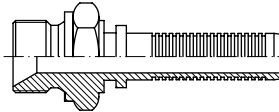

DN	THREAD ROSCA	Part n° Referencia	€
1/4"	1/4" BSP	741120404	3,71
3/8"	3/8" BSP	741120606	4,35

Macho NPT

NPT Male thread

Embout thermoplastique 700 bar mâle fixe gaz conique NPT

Maschio conico NPT

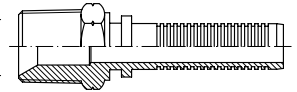

DN	THREAD ROSCA	Part n° Referencia	€
1/4"	1/4" NPT	741610404	2,99
1/4"	3/8" NPT	741610604	2,63
3/8"	3/8" NPT	741610606	3,54

Serie Compacta

One Piece Series
Série Pré-sertis
Serie Compatti

■ Conexiones compactas 1SC / 1SN / 2SC / R6 / 2TE

One piece fittings 1SC / 1SN / 2SC / R6 / 2TE
Embouts pré-sertis 1SC / 1SN / 2SC / R6 / 2TE
Raccordi compatti 1SC / 1SN / 2SC / R6 / 2TE

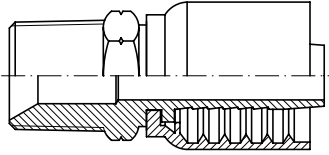

EN 857 1SC	EN 853 1 SN SAE 100 R1AT	EN 857 2SC	EN 854 SAE 100 R6	EN 854 2TE
---------------	-----------------------------------	---------------	-------------------------	---------------

■ Conexiones compactas Serie 43 R1AT / R2AT / 1SN / 2SN / R16 / 2SC / 3TE / R17

One piece fittings 43 Series R1AT / R2AT / 1SN / 2SN / R16 / 2SC / 3TE / R17
Embouts pré-sertis R1AT / R2AT / 1SN / 2SN / R16 / 2SC Série 43 / 2TE / R17
Raccordi compatti R1AT / R2AT / 1SN / 2SN / R16 / 2SC Serie 43 / 3TE / R17

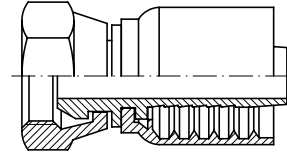

EN 853 1SN SAE 100 R1AT	EN 853 2 SN SAE 100 R2AT	EN 857 2SC SAE 100 R16	SUPERSERVICE 155° 2SC	3TE ----- R17
----------------------------------	-----------------------------------	---------------------------------	-----------------------------	---------------------

■ Conexiones compactas Serie Standard NO PELAR 3SP / 4SP / 4SH / R12

One piece fittings Standar Series NON SKIVE 3SP / 4SP / 4SH / R12
Embouts pré-sertis SANS DÉNUDÉ 3SP / 4SP / 4SH / R12
Raccordi compatti SENZA PELATURA 3SP / 4SP / 4SH / R12

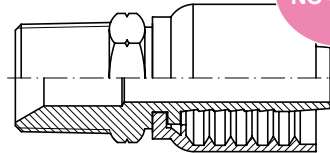

3SP	EN 856 4SP SAE 100 R9R	EN 856 4SH	EN856 R12 SAE 100
-----	------------------------------	---------------	-------------------------

■ Conexiones compactas R7 / R8 y elastómero malla metálica

Piece fittings R7 / R8 & braid of steel wire
Embouts pré-sertis R7 / R8 et tresse métallique
Raccordi compatti serie R7 / R8 e elastomero treccia metallica

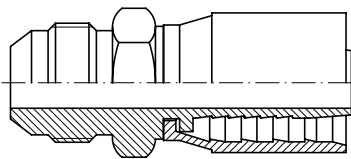

SAE 100 R7	SAE 100 R8	Metallic braid elastomer
---------------	---------------	--------------------------------

■ Conexiones compactas PTFE liso

One piece fittings for smooth PTFE
Embouts pré-sertis pour PTFE lisse
Raccordi compatti serie PTFE liscio

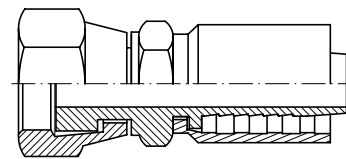

Smooth PTFE 1 braid

■ Conexiones compactas PTFE corrugado

One piece fittings for convoluted PTFE
Embouts pré-sertis pour PTFE convolute
Raccordi compatti serie PTFE convoluto

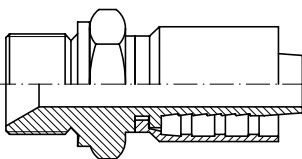

Convoluted PTFE

■ Conexiones compactas Serie BW R12 / 4SP / 4SH

One piece fittings BW Series R12 / 4SP / 4SH
Embouts pré-sertis R12 / 4SP / 4SH Série BW
Raccordi compatti R12 / 4SP / 4SH Serie BW

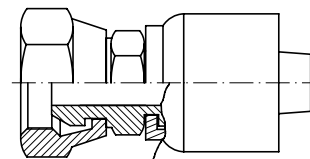

EN 856 R12	EN 856 4SP	4 SH
---------------	---------------	------

Casquillos Una sola pieza

Ferrules for One Piece Fittings
Jupes pour Embouts une seule pièce
Boccole per Raccordi un pezzo

Casquillos 1SC/1SN/2SC/R6/2TE/R17

Ferrules 1SC/1SN/2SC/R6/2TE/R17

Jupes à sertir 1SC/1SN/2SC/R6/2TE/R17

Boccole a pressare per 1SC/1SN/2SC/R6/2TE/R17

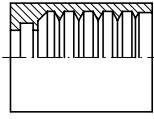

DN	Part nº Referencia	€
1/4"	SC21120400	1,23
5/16"	SC21120500	1,10
3/8"	SC21120600	1,32
1/2"	SC21120800	1,91
5/8"	SC21121000	2,60
3/4"	SC21121200	3,39
1"	SC21121600	5,83

Casquillos 1SN/2SN/R16/2SC/3TE/R17 para conexiones de una sola pieza serie 43

Ferrules 1SN/2SN/R16/2SC/3TE/R17 for one piece fittings 43 series

Jupes 1SN/2SN/R16/2SC/3TE/R17 pour embous pré-sertis série 43

Boccole a pressare 1SN/2SN/R16/2SN/3TE/R17 per raccordi compatti serie 43

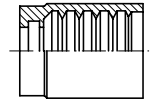

DN	Part nº Referencia	€
1/4"	PFC221200400	1,48
5/16"	PFC221200500	1,71
3/8"	PFC221200600	1,77
1/2"	PFC221200800	2,27
5/8"	PFC221201000	2,98
3/4"	PFC221201200	3,92
1"	PFC221201600	5,64
1"1/4	PFC221202000	15,32
1"1/2	PFC221202400	22,63
2"	PFC221203200	37,56

Casquillos R12/3SP/4SP/4SH no pelar

Ferrules R12/3SP/4SP/4SH non skive

Jupes à sertir R12/3SP/4SP/4SH sans dénudage

Boccole a pressare per R12/3SP/4SP/4SH senza spellatura

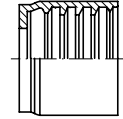

DN	Part nº Referencia	€
3/8"	DI222400600	2,19
1/2"	DI222400800	2,58
5/8"	DI222401000	3,31
3/4"	DI222401200	4,43
1"	DI222401600	7,23
1" 1/4	DI222402000	*

Casquillos R12, 4SP, 4SH para conexiones de una sola pieza serie BW

Ferrules R12, 4SP, 4SH for fittings BW series

Jupes R12, 4SP, 4SH pour embouts série BW

Boccole pressare R12, 4SP, 4SH per raccordi serie BW

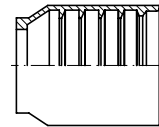

DN	Part nº Referencia	€
3/4"	AC680101200	10,68
1"	AC680101600	13,26
1" 1/4	AC680102000	22,09

Casquillos Una sola pieza

Ferrules for One Piece Fittings
 Jupes pour Embouts une seule pièce
 Boccole per Raccordi un pezzo

Casquillos R6, R7, R8 y malla metálica

Ferrules SAE 100 R6, R7, R8 and metallic braid

Jupes à sertir R6, R7, R8 et tresse métallique

Boccole a pressare per SAE R6, R7, R8 e Treccia Metallica

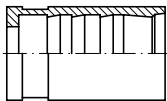

DN	Part nº Referencia	€
1/8"	DI2300200	1,05
3/16"	DI2300300	0,84
1/4"	DI2300400	0,80
5/16"	DI2300500	1,47
3/8"	DI2300600	1,19
1/2"	DI2300800	1,53
5/8"	DI2301000	2,82
3/4"	DI2301200	4,56
1"	DI2301600	7,89

Casquillos PTFE Liso alta presión

Ferrules for Smooth PTFE

Jupes à sertir pour PTFE Lisse haute pression

Boccole a pressare per tubo al PTFE Liscio alta pressione

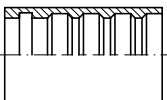

DN	Part nº Referencia	€
3/16"	210400300	1,37
1/4"	210400400	1,02
5/16"	210400500	1,43
3/8"	210400600	1,24
1/2"	210400800	1,67
5/8"	210401000	2,18
3/4"	210401200	2,84
1"	210401600	5,11

Casquillos PTFE Corrugado alta presión

Ferrules for Corrugated PTFE

Jupes à sertir PTFE Convoluté haute pression

Boccole a pressare per tubo al PTFE Corrugato alta pressione

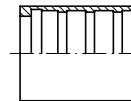

DN	Part nº Referencia	€
1/4"	210410400	1,38
3/8"	210410600	1,59
1/2"	210410800	1,78
5/8"	210411000	3,11
3/4"	210411201	3,19
1"	210411600	5,45
1" 1/4	210412001	11,55
1" 1/2	210412400	13,51
2"	210413200	23,06

Conexiones Serie 43 una sola pieza 1SN / 2SN / R16 / 2SC / 3TE / R17

One piece fittings 43 Series 1SN / 2SN / R16 / 2SC / 3TE / R17

Embouts pré-sertis Série 43 1SN / 2SN / R16 / 2SC / 3TE / R17

Raccordi un pezzo Serie 43 1SN / 2SN / R16 / 2SC / 3TE / R17

Hembras giratorias rectas una sola pieza JIC 37°

One piece JIC 37° female

Femelle pré-sertie JIC 37°

Femmina diritta compatta JIC 37°

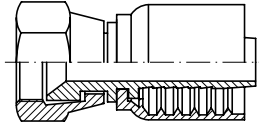

DN	THREAD ROSCA	Part nº Referencia	€
1/4"	7/16" 20h UNF	281420704	3,20
1/4"	1/2" 20h UNF	281420804	3,43
5/16"	1/2" 20h UNF	281420805	4,27
1/4"	9/16" 18h UNF	281420904	3,33
5/16"	9/16" 18h UNF	281420905	3,60
3/8"	9/16" 18h UNF	281420906	3,80
3/8"	5/8" 18h UNF	281421006	4,91
5/16"	3/4" 16h UNF	281421205	4,38
3/8"	3/4" 16h UNF	281421206	4,29
1/2"	3/4" 16h UNF	281421208	5,15
3/8"	7/8" 14h UNF	281421406	4,99
1/2"	7/8" 14h UNF	281421408	5,40
5/8"	7/8" 14h UNF	281421410	7,00
1/2"	1" 1/16 12h UNF	281421708	7,36
5/8"	1" 1/16 12h UNF	281421710	7,94
3/4"	1" 1/16 12h UN	281421712	8,42
1"	1" 1/16 12h UNF	281421716	14,48
3/4"	1" 5/16 12h UNF	281422112	13,51
1"	1" 5/16 12h UN	281422116	15,71
1"	1" 5/8 12h UNF	281422616	21,09
1" 1/4	1" 5/8 12h UN	281422620	29,03
1" 1/4	1" 7/8 12h UNF	281423020	45,31
1" 1/2	1" 7/8 12h UN	281423024	43,95
2"	2" 1/2 12h UN	281424032	75,72

Machos una sola pieza rosca JIC 37°

One piece JIC 37° male

Mâle pré-serti JIC 37°

Maschio compatto JIC sede 37°

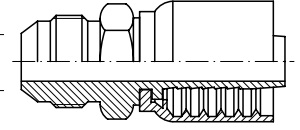

DN	THREAD ROSCA	Part nº Referencia	€
1/4"	7/16" 20h UNF	281400704	3,10
1/4"	1/2" 20 H UNF	281400804	4,13
5/16"	1/2" 20h UNF	281400805	4,19
1/4"	9/16" 18h UNF	281400904	3,40
5/16"	9/16" 18h UNF	281400905	3,87
3/8"	9/16" 18h UNF	281400906	3,58
3/8"	3/4" 16 h UNF	281401206	4,26
1/2"	3/4" 16h UNF	281401208	4,56
3/8"	7/8" 14h UNF	281401406	5,18
1/2"	7/8" 14h UNF	281401408	5,29
5/8"	7/8" 14h UNF	281401410	6,60
1/2"	1" 1/16 12h UNF	281401708	7,36
5/8"	1" 1/16-12h UNF	281401710	7,73
3/4"	1" 1/16 12h UN	281401712	9,93
3/4"	1" 5/16 12h UNF	281402112	12,33
1"	1" 5/16 12h UN	281402116	16,12
1"	1" 5/8 12h UNF	281402616	22,38
1" 1/4	1" 5/8 12h UN	281402620	33,82
1" 1/4	1" 7/8 12h UNF	281403020	41,15
1" 1/2	1" 7/8 12h UN	281403024	48,46
2"	2" 1/2 12h UN	281404032	84,84

Hembras giratorias rectas una sola pieza JIC 37° doble hexagonal

One piece double hexagonal JIC 37° female

Femelle pré-sertie JIC 37° double hexagonal

Femmina diritta JIC 37° doppio esagono

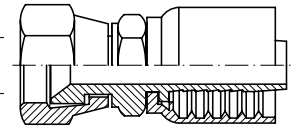

DN	THREAD ROSCA	Part nº Referencia	€
1/4"	7/16" 20h UNF	282420704	3,90
1/4"	1/2" 20h UNF	282420804	4,13
5/16"	9/16" 18h UNF	282420905	4,89
3/8"	9/16" 18h UNF	282420906	4,95
3/8"	3/4" 16h UNF	282421206	5,26
1/2"	3/4" 16h UNF	282421208	6,29
1/2"	7/8" 14h UNF	282421408	7,28
3/4"	1" 1/16 12h UN	282421712	11,35
1"	1" 5/16 12h UN	282422116	15,78
1" 1/4	1" 5/8 12h UN	282422620	36,54
1" 1/2	1" 7/8 12h UN	282423024	54,93
2"	2" 1/2 12h UN	282424032	97,05

Conexiones Serie 43 una sola pieza 1SN / 2SN / R16 / 2SC / 3TE / R17

One piece fittings 43 Series 1SN / 2SN / R16 / 2SC / 3TE / R17

Embouts pré-sertis Série 43 1SN / 2SN / R16 / 2SC / 3TE / R17

Raccordi un pezzo Serie 43 1SN / 2SN / R16 / 2SC / 3TE / R17

Hembras giratorias 90° una sola pieza JIC 37°

One piece JIC 37° Female (90° Elbow)

Coude 90° femelle pré-sertie JIC 37°

Femmina 90° compatta JIC 37°

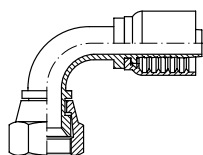

DN	THREAD ROSCA	Part n° Referencia	€
1/4"	7/16" 20h UNF	281380704	4,02
1/4"	1/2" 20h UNF	281380804	5,23
1/4"	9/16" 18h UNF	281380904	4,41
5/16"	9/16" 18h UNF	281380905	5,38
3/8"	9/16" 18h UNF	281380906	4,96
3/8"	5/8" 18h UNF	281381006	6,66
3/8"	3/4" 16h UNF	281381206	5,76
1/2"	3/4" 16h UNF	281381208	6,65
3/8"	7/8" 14h UNF	281381406	8,82
1/2"	7/8" 14h UNF	281381408	7,10
5/8"	7/8" 14h UNF	281381410	11,16
1/2"	1"1/16 12h UNF	281381708	13,55
5/8"	1"1/16 12h UNF	281381710	12,88
3/4"	1"1/16 12h UN	281381712	13,19
3/4"	1"5/16 12h UNF	281382112	20,67
1"	1"5/16 12h UN	281382116	19,97
1"	1"5/8 12h UNF	281382616	34,88
1"1/4"	1"5/8 12h UN	281382620	43,82
1" 1/4"	1"7/8 12h UNF	281383020	60,76
1"1/2"	1"7/8 12h UN	281383024	63,57
2"	2"1/2 12h UN	281384032	123,83

Hembras giratorias 45° una sola pieza JIC 37°

One piece JIC 37° Female (45° Elbow)

Coude 45° femelle pré-sertie JIC 37°

Femmina 45° compatta JIC 37°

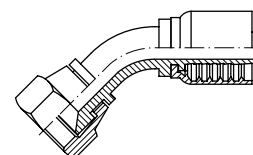

DN	THREAD ROSCA	Part n° Referencia	€
1/4"	7/16" 20h UNF	281390704	4,59
1/4"	1/2" 20h UNF	281390804	5,15
1/4"	9/16" 18h UNF	281390904	5,19
5/16"	9/16" 18h UNF	281390905	5,16
3/8"	9/16" 18h UNF	281390906	5,68
3/8"	3/4" 16h UNF	281391206	7,07
1/2"	3/4" 16h UNF	281391208	7,67
1/2"	7/8" 14h UNF	281391408	8,96
5/8"	7/8" 14h UNF	281391410	9,98
1/2"	1"1/16 12h UNF	281391708	13,19
5/8"	1"1/16 12h UNF	281391710	13,29
3/4"	1"1/16 12h UN	281391712	12,91
3/4"	1"5/16 12h UNF	281392112	21,76
1"	1"5/16 12h UN	281392116	21,19
1"	1"5/8 12h UNF	281392616	34,88
1"1/4"	1"5/8 12h UN	281392620	48,44
1" 1/4"	1"7/8 12h UNF	281393020	64,66
1"1/2"	1"7/8 12h UN	281393024	71,97
2"	2"1/2 12h UN	281394032	123,83

Machos una sola pieza rosca cónica NPT

One piece NPT male

Mâle pré-serti NPT

Maschio compatto conico NPT

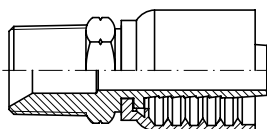

DN	THREAD ROSCA	Part n° Referencia	€
1/4"	1/8" NPT	281610204	3,44
1/4"	1/4" NPT	281610404	3,44
5/16"	1/4" NPT	281610405	4,51
3/8"	1/4" NPT	281610406	4,57
1/4"	3/8" NPT	281610604	4,28
5/16"	3/8" NPT	281610605	4,51
3/8"	3/8" NPT	281610606	4,26
1/2"	3/8" NPT	281610608	5,60
3/8"	1/2" NPT	281610806	5,10
1/2"	1/2" NPT	281610808	5,17
5/8"	1/2" NPT	281610810	7,70
1/2"	3/4" NPT	281611208	8,17
5/8"	3/4" NPT	281611210	7,83
3/4"	3/4" NPT	281611212	8,78
1"	3/4" NPT	281611216	14,27
3/4"	1" NPT	281611612	12,55
1"	1" NPT	281611616	14,27
1"	1" 1/4 NPT	281612016	22,66
1"1/4"	1"1/4 NPT	281612020	31,31
1" 1/4"	1"1/2 NPT	281612420	38,02
1"1/2"	1"1/2 NPT	281612424	45,33
1" 1/2"	2" NPT	281613224	71,85
2"	2" NPT	281613232	78,98

Hembras giratorias rectas una sola pieza rosca NPSM cono 60°

One piece NPSM female 60° cone

Femelle pré-sertie NPSM cone 60°

Femmina diritta compatta NPSM sede 60°

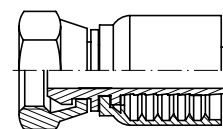

DN	THREAD ROSCA	Part n° Referencia	€
1/4"	1/4" 18h NPSM	282610404	3,94
3/8"	3/8" 18h NPSM	282610606	4,61
1/2"	1/2" 14h NPSM	282610808	5,85
3/4"	3/4" 14h NPSM	282611212	9,46
1"	1" - 11 1/2 h NPSM	282611616	14,62

Conexiones Serie 43 una sola pieza 1SN / 2SN / R16 / 2SC / 3TE / R17

One piece fittings 43 Series 1SN / 2SN / R16 / 2SC / 3TE / R17

Embouts pré-sertis Série 43 1SN / 2SN / R16 / 2SC / 3TE / R17

Raccordi un pezzo Serie 43 1SN / 2SN / R16 / 2SC / 3TE / R17

Hembras giratorias rectas una sola pieza ORFS

One piece ORFS female

Femelle pré-sertie ORFS

Femmina diritta compatta ORFS

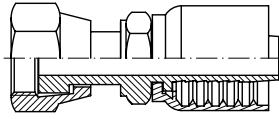

DN	THREAD ROSCA	Part nº Referencia	€
1/4"	9/16" 18h	289000904	4,31
1/4"	11/16" 16h	289001104	4,82
5/16"	11/16" 16h	289001105	5,05
3/8"	11/16" 16h	289001106	4,95
3/8"	13/16" 16h	289001306	5,75
1/2"	13/16" 16h	289001308	5,41
1/2"	1" 14h	289001608	7,66
5/8"	1" 14h	289001610	9,26
1/2"	1"3/16 12h	289001908	10,16
3/4"	1"3/16 12h	289001912	11,51
3/4"	1"7/16 12h	289002312	16,83
1"	1"7/16 12h	289002316	14,44
1"1/4	1"11/16 12h	289002720	36,47
1"1/2	2" 12h	289003224	58,40

Hembras giratorias 90° una sola pieza ORFS

One piece ORFS female (90° Elbow)

Coude 90° femelle pré-sertie ORFS

Femmina 90° compatta ORFS

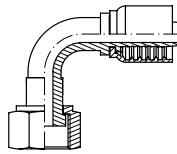

DN	THREAD ROSCA	Part nº Referencia	€
1/4"	9/16" 18h	289070904	5,29
1/4"	11/16" 16h	289071104	6,33
5/16"	11/16" 16h	289071105	6,56
3/8"	11/16" 16h	289071106	6,15
3/8"	13/16" 16h	289071306	8,19
1/2"	13/16" 16h	289071308	8,23
1/2"	1" 14h	289071608	11,90
5/8"	1" 14h	289071610	12,78
1/2"	1"3/16 12h	289071908	15,41
3/4"	1"3/16 12h	289071912	15,89
3/4"	1"7/16 12h	289072312	24,53
1"	1"7/16 12h	289072316	26,25
1"1/4	1"11/16 12h	289072720	52,53
1"1/2	2" 12h	289073224	74,38

Machos una sola pieza ORFS

One piece ORFS male

Mâle pré-serti ORFS

Maschio compatto ORFS

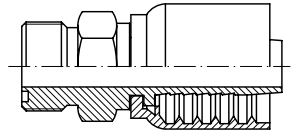

DN	THREAD ROSCA	Part nº Referencia	€
1/4"	9/16" 18h	289120904	3,91
1/4"	11/16" 16h	289121104	4,48
5/16"	11/16" 16h	289121105	4,71
3/8"	11/16" 16h	289121106	5,08
3/8"	13/16" 16h	289121306	6,07
1/2"	13/16" 16h	289121308	6,57
1/2"	1" 14h	289121608	7,47
5/8"	1" 14h	289121610	8,57
1/2"	1"3/16 12h	289121908	10,97
3/4"	1"3/16 12h	289121912	12,73
3/4"	1"7/16 12h	289122312	18,22
1"	1"7/16 12h	289122316	19,94
1"1/4	1"11/16 12h	289122720	39,34

Hembras giratorias 45° una sola pieza ORFS

One piece ORFS female (45° Elbow)

Coude 45° femelle pré-sertie ORFS

Femmina 45° compatta ORFS

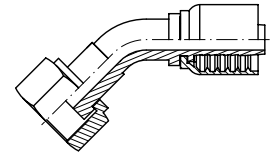

DN	THREAD ROSCA	Part nº Referencia	€
1/4"	9/16" 18h	289080904	4,48
1/2"	1" 14h	289081008	11,54
1/4"	11/16" 16h	289081104	6,33
5/16"	11/16" 16h	289081105	6,56
3/8"	11/16" 16h	289081106	6,31
3/8"	13/16" 16h	289081306	8,25
1/2"	13/16" 16h	289081308	8,89
5/8"	1" 14h	289081610	12,73
1/2"	1"3/16 12h	289081908	15,41
3/4"	1"3/16 12h	289081912	18,31
3/4"	1"7/16 12h	289082312	24,53
1"	1"7/16 12h	289082316	30,18
1"1/4	1"11/16 12h	289082720	48,52
1"1/2	2" 12h	289083224	74,38

Conexiones Serie 43 una sola pieza 1SN / 2SN / R16 / 2SC / 3TE / R17

One piece fittings 43 Series 1SN / 2SN / R16 / 2SC / 3TE / R17

Embouts pré-sertis Série 43 1SN / 2SN / R16 / 2SC / 3TE / R17

Raccordi un pezzo Serie 43 1SN / 2SN / R16 / 2SC / 3TE / R17

Hoses

Flexible hose fittings

Flow measuring

Equipment for flexible hoses

Bridas rectas una sola pieza SAE 3000 PSI

One piece 3000 PSI SAE Straight Flange / Code 61

Bride SAE droite pré-sertie série 3000 PSI

Flangia diritta compatta SAE 3000 PSI

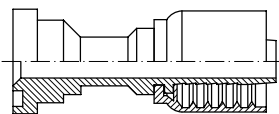

DN	Ø	Part n° Referencia	€
1/2"	30.2	281820808	8,86
1/2"	38.1	281821208	12,17
5/8"	38.1	281821210	14,27
3/4"	38.1	281821212	13,99
3/4"	44.5	281821612	20,31
1"	44.5	281821616	19,56
1"	50.8	281822016	29,31
1"1/4	50.8	281822020	34,91
1" 1/4	60.3	281822420	50,82
1"1/2	60.3	281822424	59,66
1" 1/2	71.4	281823224	88,15
2"	71.4	281823232	97,18

Bridas rectas una sola pieza SAE 6000 PSI

One piece 6000 PSI SAE Straight Flange / Code 62

Bride SAE droite pré-sertie série 6000 PSI

Flangia diritta compatta SAE 6000 PSI

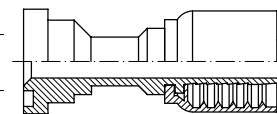

DN	Ø	Part n° Referencia	€
1/2"	31.8	282820808	10,01
1/2"	41.3	282821208	13,45
5/8"	41.3	282821210	14,91
3/4"	41.3	282821212	16,87
3/4"	47.6	282821612	21,98
1"	47.6	282821616	24,21
1"	54	282822016	30,07
1"1/4	54	282822020	41,25
1" 1/4	63.5	282822420	52,74
1"1/2	63.5	282822424	62,22
1" 1/2	79.4	282823224	93,83
2"	79.4	282823232	91,94

Bridas 90° una sola pieza SAE 3000 PSI

One piece 3000 PSI SAE 90° Flange / Code 61

Bride SAE coude 90° pré-sertie série 3000 PSI

Flangia 90° compatta SAE 3000 PSI

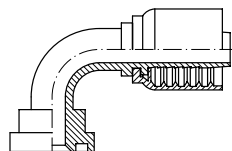

DN	Ø	Part n° Referencia	€
1/2"	30.2	281830808	10,86
1/2"	38.1	281831208	14,33
5/8"	38.1	281831210	15,44
3/4"	38.1	281831212	16,32
3/4"	44.5	281831612	22,61
1"	44.5	281831616	24,80
1"	50.8	281832016	32,48
1"1/4	50.8	281832020	43,55
1" 1/4	60.3	281832420	55,64
1"1/2	60.3	281832424	64,22
1" 1/2	71.4	281833224	94,68
2"	71.4	281833232	114,37

Bridas 90° una sola pieza SAE 6000 PSI

One piece 6000 PSI SAE 90° Flange / Code 62

Bride SAE coude 90° pré-sertie série 6000 PSI

Flangia 90° compatta SAE 6000 PSI

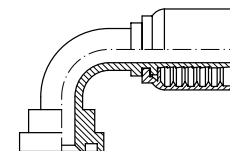

DN	Ø	Part n° Referencia	€
1/2"	31.8	282830808	11,51
1/2"	41.3	282831208	16,24
5/8"	41.3	282831210	15,65
3/4"	41.3	282831212	16,80
3/4"	47.6	282831612	24,19
1"	47.6	282831616	26,38
1"	54	282832016	34,53
1"1/4	54	282832020	45,31
1" 1/4	63.5	282832420	58,49
1"1/2	63.5	282832424	67,40
1" 1/2	79.4	282833224	99,44

Bridas 45° una sola pieza SAE 3000 PSI

One piece 3000 PSI SAE 45° Flange / Code 61

Bride SAE coude 45° pré-sertie série 3000 PSI

Flangia 45° compatta SAE 3000 PSI

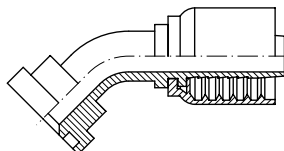

DN	Ø	Part n° Referencia	€
1/2"	30.2	281840808	10,86
1/2"	38.1	281841208	14,33
5/8"	38.1	281841210	15,44
3/4"	38.1	281841212	16,32
3/4"	44.5	281841612	22,61
1"	44.5	281841616	24,80
1"	50.8	281842016	32,48
1"1/4	50.8	281842020	43,55
1" 1/4	60.3	281842420	55,64
1"1/2	60.3	281842424	64,22
1" 1/2	71.4	281843224	94,68
2"	71.4	281843232	114,37

Bridas 45° una sola pieza SAE 6000 PSI

One piece 6000 PSI SAE 45° Flange / Code 62

Bride SAE coude 45° pré-sertie série 6000 PSI

Flangia 45° compatta SAE 6000 PSI

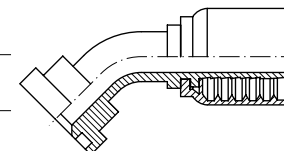

DN	Ø	Part n° Referencia	€
1/2"	31.8	282840808	11,51
1/2"	41.3	282841208	16,24
5/8"	41.3	282841210	15,65
3/4"	41.3	282841212	16,80
3/4"	47.6	282841612	24,19
1"	47.6	282841616	26,38
1"	54	282842016	34,53
1"1/4	54	282842020	45,31
1" 1/4	63.5	282842420	58,49
1"1/2	63.5	282842424	67,40
1" 1/2	79.4	282843224	99,44
2"	79.4	282843232	115,95

Conexiones Serie 43 una sola pieza 1SN / 2SN / R16 / 2SC / 3TE / R17

One piece fittings 43 Series 1SN / 2SN / R16 / 2SC / 3TE / R17

Embouts pré-sertis Série 43 1SN / 2SN / R16 / 2SC / 3TE / R17

Raccordi un pezzo Serie 43 1SN / 2SN / R16 / 2SC / 3TE / R17

Bridas rectas una sola pieza SAE 9000 PSI

One piece 9000 PSI SAE Straight Flange / Code 61

Bride SAE droite pré-sertie série 9000 PSI

Flangia diritta compatta SAE 9000 PSI

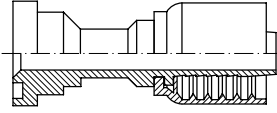

DN	Ø	Part n° Referencia	€
1/2"	41.3	482821212	17,59
3/4"	47.6	482821612	25,79
1"	47.6	482821616	27,51
1"	54	482822016	32,86
1" 1/4	54	482822020	42,76
1" 1/2	63.5	482822424	69,97

Bridas 45° una sola pieza SAE 9000 PSI

One piece 9000 PSI SAE 45° Flange / Code 61

Bride SAE coude 45° pré-sertie série 9000 PSI

Flangia 45° compatta SAE 9000 PSI

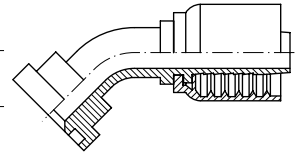

DN	Ø	Part n° Referencia	€
1/2"	41.3	482841212	21,41
3/4"	47.6	482841612	31,14
1"	47.6	482841616	32,86
1"	54	482842016	43,25
1" 1/4	54	482842020	53,15
1" 1/2	63.5	482842424	69,97

Bridas 90° una sola pieza SAE 9000 PSI

One piece 9000 PSI SAE 90° Flange / Code 61

Bride SAE coude 90° pré-sertie série 9000 PSI

Flangia 90° compatta SAE 9000 PSI

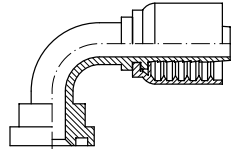

DN	Ø	Part n° Referencia	€
1/2"	41.3	482831212	21,41
3/4"	47.6	482831612	31,14
1"	47.6	482831616	32,86
1"	54	482832016	43,25
1" 1/4	54	482832020	53,15
1" 1/2	63.5	482832424	69,97

Conexiones Serie 43 una sola pieza 1SN / 2SN / R16 / 2SC / 3TE / R17

One piece fittings 43 Series 1SN / 2SN / R16 / 2SC / 3TE / R17

Embouts pré-sertis Série 43 1SN / 2SN / R16 / 2SC / 3TE / R17

Raccordi un pezzo Serie 43 1SN / 2SN / R16 / 2SC / 3TE / R17

Hembras giratorias rectas una sola pieza rosca Métrica cono 24° - DKO

One piece Metric female cone 24°

Femelle pré-sertie Métrique cone 24°

Femmina diritta compatta Metrica sede 24°

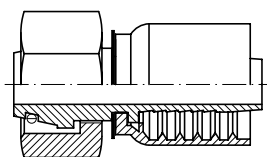

DN	PIPE TUBO	SERIE	THREAD ROSCA	Part nº Referencia	€
1/4"	6	L	M12x1.5	28804120604	3,33
1/4"	8	L	M14x1.5	28804140804	3,22
1/4"	10	L	M16x1.5	28804161004	3,51
5/16"	10	L	M16x1.5	28804161005	3,82
3/8"	10	L	M16x1.5	28804161006	4,35
1/4"	12	L	M18x1.5	28804181204	3,84
5/16"	12	L	M18x1.5	28804181205	3,97
3/8"	12	L	M18x1.5	28804181206	3,93
3/8"	15	L	M22x1.5	28804221506	5,16
1/2"	15	L	M22x1.5	28804221508	5,20
1/2"	18	L	M26x1.5	28804261808	7,09
5/8"	18	L	M26x1.5	28804261810	6,69
3/4"	22	L	M30x2	28804302212	9,38
1"	28	L	M36x2	28804362816	15,90
1"1/4	35	L	M45x2	28804453520	31,09
1"1/2	42	L	M52x2	28804524224	44,13
1/4"	8	S	M16x1.5	28804160804	3,63
1/4"	10	S	M18x1.5	28804181004	4,08
5/16"	12	S	M20x1.5	28804201205	3,97
3/8"	12	S	M20x1.5	28804201206	4,11
1/2"	12	S	M20x1.5	28804201208	7,47
3/8"	14	S	M22x1.5	28804221406	4,99
1/2"	16	S	M24x1.5	28804241608	5,82
5/8"	20	S	M30x2	28804302010	7,56
3/4"	20	S	M30x2	28804302012	10,16
3/4"	25	S	M36x2	28804362512	13,59
1"	25	S	M36x2	28804362516	17,53
1"	30	S	M42x2	28804423016	19,59
1"1/4	38	S	M52x2	28804523820	35,55

Machos una sola pieza rosca Métrica cono 24°

One piece Metric male cone 24°

Mâle pré-serti Métrique cone 24°

Maschio compatto Metrico sede 24°

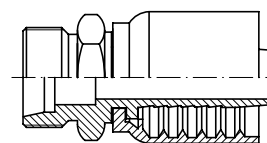

DN	PIPE TUBO	SERIE	THREAD ROSCA	Part nº Referencia	€
1/4"	6	L	M12x1.5	28203120604	3,34
1/4"	8	L	M14x1.5	28203140804	3,37
1/4"	10	L	M16x1.5	28203161004	3,66
5/16"	10	L	M16x1.5	28203161005	3,83
3/8"	10	L	M16x1.5	28203161006	3,75
1/4"	12	L	M18x1.5	28203181204	3,66
5/16"	12	L	M18x1.5	28203181205	4,13
3/8"	12	L	M18x1.5	28203181206	3,67
3/8"	15	L	M22x1.5	28203221506	4,70
1/2"	15	L	M22x1.5	28203221508	5,01
1/2"	18	L	M26x1.5	28203261808	6,04
5/8"	18	L	M26x1.5	28203261810	6,41
3/4"	22	L	M30x2	28203302212	9,07
1"	28	L	M36x2	28203362816	15,83
1"1/4	35	L	M45x2	28203453520	30,02
1"1/2	42	L	M52x2	28203524224	45,70
1/4"	8	S	M16x1.5	28203160804	3,64
1/4"	10	S	M18x1.5	28203181004	4,21
5/16"	10	S	M18x1.5	28203181005	4,21
3/8"	10	S	M18x1.5	28203181006	4,35
5/16"	12	S	M20x1.5	28203201205	4,26
3/8"	12	S	M20x1.5	28203201206	4,43
3/8"	14	S	M22x1.5	28203221406	4,84
1/2"	16	S	M24x1.5	28203241608	5,70
5/8"	20	S	M30x2	28203302010	8,07
3/4"	20	S	M30x2	28203302012	9,85
3/4"	25	S	M36x2	28203362512	14,10
1"	25	S	M36x2	28203362516	16,02
1"	30	S	M42x2	28203423016	20,10
1"1/4	38	S	M52x2	28203523820	38,24

Conexiones Serie 43 una sola pieza 1SN / 2SN / R16 / 2SC / 3TE / R17

One piece fittings 43 Series 1SN / 2SN / R16 / 2SC / 3TE / R17

Embouts pré-sertis Série 43 1SN / 2SN / R16 / 2SC / 3TE / R17

Raccordi un pezzo Serie 43 1SN / 2SN / R16 / 2SC / 3TE / R17

Hembras giratorias 90° una sola pieza Métricas cono 24° - DKO 90°

One piece Metric female cone 24° (90° Elbow)

Coude 90° femelle pré-sertie Métrique cono 24°

Femmina 90° compatta Metrica sede 24°

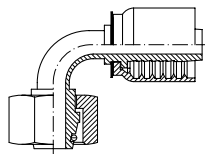

DN	PIPE TUBO	SERIE	THREAD ROSCA	Part nº Referencia	€
1/4"	6	L	M12x1.5	28305120604	4,38
1/4"	8	L	M14x1.5	28305140804	4,42
1/4"	10	L	M16x1.5	28305161004	4,61
5/16"	10	L	M16x1.5	28305161005	4,87
3/8"	10	L	M16x1.5	28305161006	5,15
5/16"	12	L	M18x1.5	28305181205	5,52
3/8"	12	L	M18x1.5	28305181206	4,95
3/8"	15	L	M22x1.5	28305221506	7,16
1/2"	15	L	M22x1.5	28305221508	6,85
5/8"	18	L	M26x1.5	28305261810	10,52
3/4"	22	L	M30x2	28305302212	15,10
1"	28	L	M36x2	28305362816	22,78
1 1/4"	35	L	M45x2	28305453520	43,02
1 1/2"	42	L	M52x2	28305524224	71,31
1/4"	8	S	M16x1.5	28305160804	4,53
1/4"	10	S	M18x1.5	28305181004	4,59
5/16"	10	S	M18x1.5	28305181005	5,81
5/16"	12	S	M20x1.5	28305201205	6,35
3/8"	12	S	M20x1.5	28305201206	4,93
3/8"	14	S	M22x1.5	28305221406	7,44
1/2"	16	S	M24x1.5	28305241608	7,28
5/8"	20	S	M30x2	28305302010	11,60
3/4"	20	S	M30x2	28305302012	15,10
3/4"	25	S	M36x2	28305362512	18,28
1"	25	S	M36x2	28305362516	24,82
1"	30	S	M42x2	28305423016	29,74
1 1/4"	38	S	M52x2	28305523820	53,96

Hembras giratorias 45° una sola pieza Métricas cono 24° - DKO 45°

One piece Metric female cone 24° (45° Elbow)

Coude 45° femelle pré-sertie Métrique cono 24°

Femmina 45° compatta Metrica sede 24°

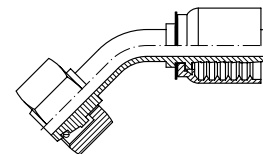

DN	PIPE TUBO	SERIE	THREAD ROSCA	Part nº Referencia	€
1/4"	6	L	M12x1.5	28306120604	4,50
1/4"	8	L	M14x1.5	28306140804	4,49
1/4"	10	L	M16x1.5	28306161004	4,75
5/16"	10	L	M16x1.5	28306161005	4,88
3/8"	10	L	M16x1.5	28306161006	5,37
5/16"	12	L	M18x1.5	28306181205	6,04
3/8"	12	L	M18x1.5	28306181206	4,85
1/2"	15	L	M22x1.5	28306221508	7,53
5/8"	18	L	M26x1.5	28306261810	10,68
3/4"	22	L	M30x2	28306302212	14,85
1"	28	L	M36x2	28306362816	22,84
1 1/4"	35	L	M45x2	28306453520	45,14
1 1/2"	42	L	M52x2	28306524224	69,77
1/4"	8	S	M16x1.5	28306160804	5,27
1/4"	10	S	M18x1.5	28306181004	5,93
5/16"	12	S	M20x1.5	28306201205	6,70
3/8"	12	S	M20x1.5	28306201206	6,57
3/8"	14	S	M22x1.5	28306221406	7,44
1/2"	16	S	M24x1.5	28306241608	7,84
5/8"	20	S	M30x2	28306302010	12,64
3/4"	20	S	M30x2	28306302012	15,63
3/4"	25	S	M36x2	28306362512	20,04
1"	25	S	M36x2	28306362516	22,84
1"	30	S	M42x2	28306423016	27,97
1 1/4"	38	S	M52x2	28306523820	57,06

Orientable una sola pieza Métrico Recto

One piece Banjo metric

Banjo droit pré-serti Métrique

Raccordo ad occhio Metrico compatto

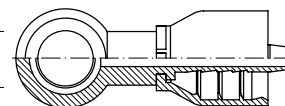

DN	Ø	Part nº Referencia	€
1/4"	M10x1	281161004	4,20
1/4"	M12x1.5	281161204	4,51
1/4"	M14x1.5	281161404	4,51
5/16"	M14x1.5	281161405	5,03
3/8"	M14x1.5	281161406	5,39
5/16"	M16x1.5	281161605	5,37
3/8"	M16x1.5	281161606	5,30
3/8"	M18x1.5	281161806	6,40
1/2"	M18x1.5	281161808	6,90
1/2"	M22x1.5	281162208	9,20
5/8"	M22x1.5	281162210	8,33
3/4"	M30x2	281163012	15,28

Conexiones Serie 43 una sola pieza 1SN / 2SN / R16 / 2SC / 3TE / R17

One piece fittings 43 Series 1SN / 2SN / R16 / 2SC / 3TE / R17

Embouts pré-sertis Série 43 1SN / 2SN / R16 / 2SC / 3TE / R17

Raccordi un pezzo Serie 43 1SN / 2SN / R16 / 2SC / 3TE / R17

Hembras giratorias una sola pieza Métricas cono 24°/60°

One piece Female metric swivel 24°/60° cone

Femelle tournante pré-sertie Métrique cône 24°-60°

Femmina Metrica Girevole Multiseal compatta 24°/60°

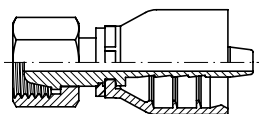

DN	PIPE TUBO	THREAD ROSCA	Part n° Referencia	€
1/4"	8L	M14X1.5	284049511	3,46
1/4"	10L	M16X1.5	284049520	3,79
5/16"	10L	M16X1.5	284049523	3,98
3/8"	10L	M16X1.5	284049524	4,53
5/16"	12L	M18X1.5	284049525	4,21
3/8"	12L	M18X1.5	284049535	4,39
3/8"	15L	M22X1.5	284049552	5,54
1/2"	15L	M22X1.5	284049555	6,45
5/8"	18L	M26X1.5	284049571	8,14

Hembras giratorias 90° una sola pieza Métricas cono 24°/60°

One piece Female metric swivel 24°/60° cone (90° Elbow)

Femelle tournante coude 90° pré-sertie Métrique cône 24°-60°

Femmina Metrica Girevole a 90° Multiseal compatta 24°/60°

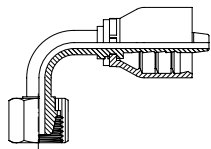

DN	PIPE TUBO	THREAD ROSCA	Part n° Referencia	€
1/4"	8L	M14X1.5	284059511	3,90
1/4"	10L	M16X1.5	284059520	4,22
5/16"	10L	M16X1.5	284059523	4,34
3/8"	10L	M16X1.5	284059524	5,17
5/16"	12L	M18X1.5	284059525	4,71
3/8"	12L	M18X1.5	284059535	4,77
3/8"	15L	M22X1.5	284059552	6,22
1/2"	15L	M22X1.5	284059555	7,43
5/8"	18L	M26X1.5	284059571	10,25

Hembras giratorias 45° una sola pieza Métricas cono 24°/60°

One piece Female metric swivel 24°/60° cone (45° Elbow)

Femelle tournante coude 45° pré-sertie Métrique cône 24°-60°

Femmina Metrica Girevole a 45° Multiseal compatta 24°/60°

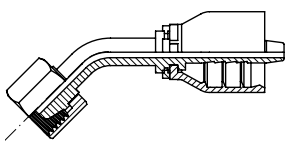

DN	PIPE TUBO	THREAD ROSCA	Part n° Referencia	€
1/4"	8L	M14X1.5	284069511	5,09
5/16"	10L	M16X1.5	284069523	5,54
3/8"	10L	M16X1.5	284069524	6,22
5/16"	12L	M18X1.5	284069525	6,16
3/8"	12L	M18X1.5	284069535	4,91
1/2"	15L	M22X1.5	284069555	8,50
5/8"	18L	M26X1.5	284069571	12,19

Espiga lisa recta una sola pieza Métrica

One piece Metric standpipe

Embout lisse droit pré-serti Métrique

Estremità tubolare diritta Metrica compatta

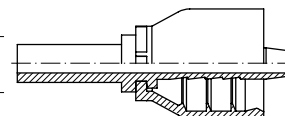

DN	PIPE TUBO	Part n° Referencia	€
1/4"	6	281580604	2,72
1/4"	8	281580804	2,75
5/16"	8	281580805	5,75
1/4"	10	281581004	2,84
5/16"	10	281581005	3,70
3/8"	10	281581006	3,36
1/4"	12	281581204	3,57
5/16"	12	281581205	3,69
3/8"	12	281581206	3,27
1/2"	12	281581208	7,32
3/8"	14	281581406	4,28
1/2"	14	281581408	5,35
3/8"	15	281581506	3,87
1/2"	15	281581508	4,50
1/2"	16	281581608	5,13
1/2"	18	281581808	4,62
5/8"	18	281581810	6,91
3/4"	20	281582012	8,98
3/4"	22	281582212	8,98
1"	25	281582516	14,72
1"	28	281582816	14,25
1"	30	281583016	14,37
1"1/4	35	281583520	29,44
1"1/2	42	281584224	40,70

Hembras giratorias rectas una sola pieza Komatsu cono 60°

One piece Komatsu swivel female 60° cone

Femelle tournante droite Komatsu pré-serti Métrique (cône 60°)

Femmina Komatsu sede 60° compatta

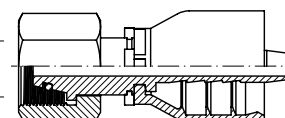

DN	THREAD ROSCA	Part n° Referencia	€
1/4"	M14X1.5	288049625	5,87
3/8"	M18X1.5	288049635	5,76
1/2"	M22X1.5	288049655	9,45
5/8"	M24X1.5	288049665	12,84
3/4"	M30X1.5	288049684	17,17
1"	M33X1.5	288049685	19,76

Espigas de prensar dobles una sola pieza

One piece Double crimp standpipe

Embout double jonction pré-serti

Giunzione tubo-tubo compatta

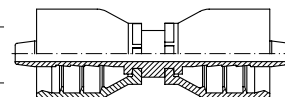

DN	Part n° Referencia	€
1/4"	283000404	3,10
5/16"	283000505	3,99
3/8"	283000606	4,13
1/2"	283000808	4,97
3/4"	283001212	12,73
1"	283001616	19,59

Conexiones Serie 43 una sola pieza 1SN / 2SN / R16 / 2SC / 3TE / R17

One piece fittings 43 Series 1SN / 2SN / R16 / 2SC / 3TE / R17

Embouts pré-sertis Série 43 1SN / 2SN / R16 / 2SC / 3TE / R17

Raccordi un pezzo Serie 43 1SN / 2SN / R16 / 2SC / 3TE / R17

Hembras giratorias rectas una sola pieza rosca BSP cono 60°

One piece BSP female 60° cone

Femelle pré-sertie BSP cono 60°

Femmina diritta compatta BSP sede 60°

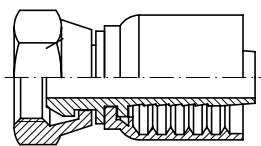

DN	THREAD ROSCA	Part nº Referencia	€
1/4"	1/8" BSP	281000204	3,46
3/16"	1/4" BSP	281000403	3,49
1/4"	1/4" BSP	281000404	3,15
5/16"	1/4" BSP	281000405	3,76
3/8"	1/4" BSP	281000406	4,25
1/4"	3/8" BSP	281000604	3,80
5/16"	3/8" BSP	281000605	3,89
3/8"	3/8" BSP	281000606	3,83
1/2"	3/8" BSP	281000608	4,82
1/4"	1/2" BSP	281000804	4,45
3/8"	1/2" BSP	281000806	4,52
1/2"	1/2" BSP	281000808	4,94
5/8"	1/2" BSP	281000810	6,89
1/2"	5/8" BSP	281001008	6,29
5/8"	5/8" BSP	281001010	6,74
1/2"	3/4" BSP	281001208	6,93
3/4"	3/4" BSP	281001212	8,54
3/4"	1" BSP	281001612	11,58
1"	1" BSP	281001616	13,09

Hembras giratorias rectas una sola pieza rosca BSP cono 60° doble hexagonal

One piece double hexagonal BSP female 60° cone

Femelle pré-sertie BSP cono 60° double hexagonal

Femmina diritta compatta BSP sede 60° doppio esagono

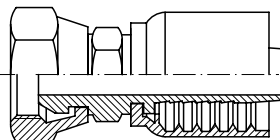

DN	THREAD ROSCA	Part nº Referencia	€
1/4"	1/4" BSP	284000404	4,33
5/16"	3/8" BSP	284000605	4,90
3/8"	3/8" BSP	284000606	5,17
1/2"	1/2" BSP	284000808	6,37
3/4"	3/4" BSP	284001212	12,16
1"	1" BSP	284001616	16,48
1"1/4"	1"1/4" BSP	284002020	38,82
1"1/2"	1"1/2" BSP	284002424	57,84
2"	2" BSP	284003232	96,07

Hembras giratorias 90° una sola pieza BSP cono 60° (compactas)

One piece BSP Swivel female 60° cone compact (90° Elbow)

Coude 90° femelle tournante pré-serti compact gaz cyl BSP 60°

Femmina a 90° compatta BSP sede 60° (compatta)

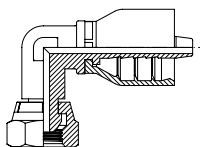

DN	THREAD ROSCA	Part nº Referencia	€
1/4"	1/4" BSP	281270404	5,76
3/8"	3/8" BSP	281270606	7,02
1/2"	1/2" BSP	281270808	8,76
3/4"	3/4" BSP	281271212	14,76

Hembras giratorias 90° una sola pieza rosca BSP cono 60°

One piece BSP female cone 60° (90° Elbow)

Coude 90° femelle pré-sertie BSP cono 60°

Femmina 90° compatta BSP sede 60°

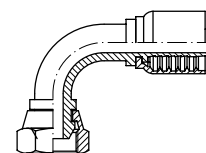

DN	THREAD ROSCA	Part nº Referencia	€
1/4"	1/8" BSP	281070204	3,90
1/4"	1/4" BSP	281070404	4,04
1/4"	3/8" BSP	281070604	4,88
5/16"	3/8" BSP	281070605	5,42
3/8"	3/8" BSP	281070606	4,96
1/4"	1/2" BSP	281070804	6,73
3/8"	1/2" BSP	281070806	5,86
1/2"	1/2" BSP	281070808	6,28
1/2"	5/8" BSP	281071008	10,15
5/8"	5/8" BSP	281071010	10,13
1/2"	3/4" BSP	281071208	10,10
3/4"	5/8" BSP	281071210	10,78
3/4"	3/4" BSP	281071212	11,68
1"	3/4" BSP	281071612	17,55
1"	1" BSP	281071616	19,76

Hembras giratorias 45° una sola pieza rosca BSP cono 60°

One piece BSP female 60° cone (45° Elbow)

Coude 45° femelle pré-sertie BSP cono 60°

Femmina 45° compatta BSP sede 60°

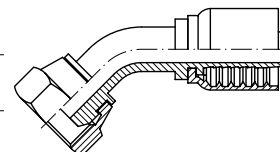

DN	THREAD ROSCA	Part nº Referencia	€
1/4"	1/8" BSP	281080204	3,93
1/4"	1/4" BSP	281080404	4,08
1/4"	3/8" BSP	281080604	5,39
5/16"	3/8" BSP	281080605	5,42
3/8"	3/8" BSP	281080606	5,31
3/8"	1/2" BSP	281080806	6,47
1/2"	1/2" BSP	281080808	7,21
1/2"	5/8" BSP	281081008	9,46
5/8"	5/8" BSP	281081010	10,28
5/8"	3/4" BSP	281081210	11,69
3/4"	3/4" BSP	281081212	13,19
3/4"	1" BSP	281081612	19,15
1"	1" BSP	281081616	19,86

Conexiones Serie 43 una sola pieza 1SN / 2SN / R16 / 2SC / 3TE / R17

One piece fittings 43 Series 1SN / 2SN / R16 / 2SC / 3TE / R17

Embouts pré-sertis Série 43 1SN / 2SN / R16 / 2SC / 3TE / R17

Raccordi un pezzo Serie 43 1SN / 2SN / R16 / 2SC / 3TE / R17

Hembras giratorias rectas una sola pieza rosca BSP cono 60° con junta tórica

One piece BSP female 60° cone +o'ring

Femelle pré-sertie BSP cone 60°+ o'ring

Femmina diritta compatta BSP sede 60°+o'ring

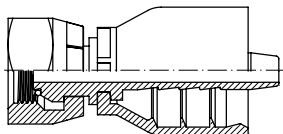

DN	THREAD ROSCA	Part nº Referencia	€
1/4"	1/4" BSP	281100404	3,76
3/8"	3/8" BSP	281100606	4,31
1/2"	1/2" BSP	281100808	5,84
5/8"	5/8" BSP	281101010	8,54
5/8"	3/4" BSP	281101210	8,16
3/4"	3/4" BSP	281101212	8,66
1"	1" BSP	281101616	15,52
1"	1"1/4 BSP	281102016	22,47
1" 1/4	1" 1/2 BSP	281102420	38,50
1" 1/2	2" BSP	281103224	63,57
1" 1/4	1"1/4 BSP	281102020	33,14
1" 1/2	1" 1/2 BSP	281102424	45,59
2"	2" BSP	281103232	78,75

Hembras giratorias 90° una sola pieza rosca BSP cono 60° con junta tórica

One piece BSP female cone 60° (90° Elbow) +o'ring

Coude 90° femelle pré-sertie BSP cone 60° +o'ring

Femmina 90° compatta BSP sede 60° +o'ring

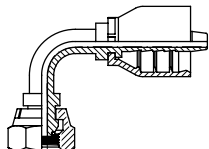

DN	THREAD ROSCA	Part nº Referencia	€
1/4"	1/4" BSP	281170404	5,22
3/8"	3/8" BSP	281170606	6,51
1/2"	1/2" BSP	281170808	8,77
5/8"	5/8" BSP	281171010	11,65
3/4"	3/4" BSP	281171212	14,34
1"	1" BSP	281171616	23,71
1"	1" 1/4 BSP	281172016	33,36
1" 1/4	1" 1/4 BSP	281172020	47,99
1" 1/4	1" 1/2 BSP	281172420	63,41
1" 1/2	1" 1/2 BSP	281172424	60,42
2"	2" BSP	281173232	126,60

Hembras giratorias 45° una sola pieza rosca BSP cono 60° con junta tórica

One piece BSP female 60° cone (45° Elbow) +o'ring

Coude 45° femelle pré-sertie BSP cone 60° +o'ring

Femmina 45° compatta BSP sede 60° +o'ring

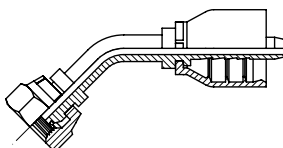

DN	THREAD ROSCA	Part nº Referencia	€
3/8"	3/8" BSP	281180606	5,34
1/2"	1/2" BSP	281180808	6,75
5/8"	5/8" BSP	281181010	11,65
3/4"	3/4" BSP	281181212	17,82
1"	1" BSP	281181616	21,17
1" 1/4	1" 1/4 BSP	281182020	37,67
1" 1/2	1" 1/2 BSP	281182424	53,00
2"	2" BSP	281183232	86,43

Hembras giratorias rectas una sola pieza BSP asiento plano

One piece BSP Swivel female flat seat

Femelle pré-sertie tournante fond plat BSP

Femmina diritta compatta BSP sede piana

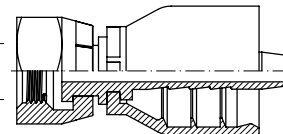

DN	THREAD ROSCA	Part nº Referencia	€
1/4"	1/4" BSP	282000404	3,58
5/16"	3/8" BSP	282000605	4,45
3/8"	3/8" BSP	282000606	4,51
3/8"	1/2" BSP	282000806	5,39
1/2"	1/2" BSP	282000808	5,89
1/2"	3/4" BSP	282001208	7,37
3/4"	3/4" BSP	282001212	9,53
1"	1" BSP	282001616	14,46
1" 1/4	1" 1/4 BSP	282002020	34,35
1" 1/2	1" 1/2 BSP	282002424	47,39

Hembras giratorias 90° una sola pieza BSP asiento plano

One piece BSP Swivel female flat seat (90° Elbow)

Embout pré-serti coude 90° femelle tournante fond plat BSP

Femmina a 90° compatta BSP sede 60° sede piana

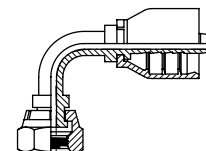

DN	THREAD ROSCA	Part nº Referencia	€
1/4"	1/4" BSP	282070404	4,71
3/8"	3/8" BSP	282070606	6,04
1/2"	1/2" BSP	282070808	7,17
3/4"	3/4" BSP	282071212	14,73
1"	1" BSP	282071616	24,64

Macho rosca cilíndrica BSP una sola pieza asiento plano

One piece BSP Male flat seat

Mâle pré-serti fixe gaz cyl fond plat

Maschio BSP compatto cilindrico sede piana

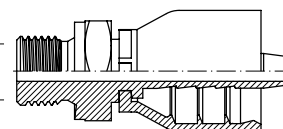

DN	THREAD ROSCA	Part nº Referencia	€
1/4"	1/4" BSP	282120404	4,33
3/8"	3/8" BSP	282120606	5,42
3/8"	1/2" BSP	282120806	6,75
1/2"	1/2" BSP	282120808	7,05
3/4"	3/4" BSP	282121212	11,13
1"	1" BSP	282121616	18,61

Conexiones Serie 43 una sola pieza 1SN / 2SN / R16 / 2SC / 3TE / R17

One piece fittings 43 Series 1SN / 2SN / R16 / 2SC / 3TE / R17

Embouts pré-serti Série 43 1SN / 2SN / R16 / 2SC / 3TE / R17

Raccordi un pezzo Serie 43 1SN / 2SN / R16 / 2SC / 3TE / R17

Machos una sola pieza rosca cilíndrica BSP cono 60°

One piece BSP male 60° cone

Mâle pré-serti BSP cone 60°

Maschio compatto cilindrico BSP sede 60°

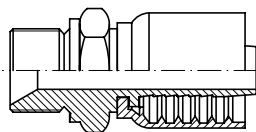

DN	THREAD ROSCA	Part n° Referencia	€
1/4"	1/8" BSP	281120204	3,41
1/4"	1/4" BSP	281120404	3,24
3/8"	1/4" BSP	281120406	4,44
1/4"	3/8" BSP	281120604	3,94
5/16"	3/8" BSP	281120605	4,16
3/8"	3/8" BSP	281120606	3,98
1/2"	3/8" BSP	281120608	5,20
1/4"	1/2" BSP	281120804	4,75
3/8"	1/2" BSP	281120806	4,67
1/2"	1/2" BSP	281120808	5,17
1/2"	5/8" BSP	281121008	7,82
5/8"	5/8" BSP	281121010	7,59
1/2"	3/4" BSP	281121208	7,70
5/8"	3/4" BSP	281121210	8,54
3/4"	3/4" BSP	281121212	8,79
3/4"	1" BSP	281121612	14,30
1"	1" BSP	281121616	13,47
1"	1"1/4 BSP	281122016	25,57
1"1/4"	1"1/4 BSP	281122020	34,91
1"1/2"	1"1/2 BSP	281122424	43,71
2"	2" BSP	281123232	87,54

Macho rosca cónica una sola pieza BSPT

One piece BSPT Male tapered

Mâle pré-serti fixe gaz conique BSPT

Maschio BSPT compatto conico

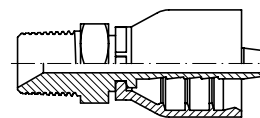

DN	THREAD ROSCA	Part n° Referencia	€
1/4"	1/8" BSPT	281140204	2,97
1/4"	1/4" BSPT	281140404	2,97
1/4"	3/8" BSPT	281140604	3,67
5/16"	3/8" BSPT	281140605	3,92
3/8"	3/8" BSPT	281140606	3,85
3/8"	1/2" BSPT	281140806	4,43
1/2"	1/2" BSPT	281140808	5,02
5/8"	3/4" BSPT	281141210	7,50
3/4"	3/4" BSPT	281141212	9,01
3/4"	1" BSPT	281141612	12,71
1"	1" BSPT	281141616	15,39
1"	1"1/4 BSPT	281142016	21,19
1"1/4"	1"1/4 BSPT	281142020	33,56
1"1/2"	1"1/2 BSPT	281142424	40,54
2"	2" BSPT	281143232	81,25

Orientable una sola pieza BSP

One piece Banjo BSP

Embout pré-serti Banjo droit gaz

Raccordo ad occhio compatto BSP

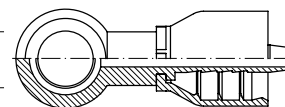

DN	THREAD ROSCA	Part n° Referencia	€
1/4"	1/4" BSP	281110404	4,22
5/16"	1/4" BSP	281110405	5,01
3/8"	1/4" BSP	281110406	5,07
1/4"	3/8" BSP	281110604	5,43
5/16"	3/8" BSP	281110605	5,96
3/8"	3/8" BSP	281110606	5,22
1/2"	3/8" BSP	281110608	6,11
3/8"	1/2" BSP	281110806	7,21
1/2"	1/2" BSP	281110808	7,75
5/8"	5/8" BSP	281111010	14,02
1/2"	3/4" BSP	281111208	14,00
5/8"	3/4" BSP	281111210	15,96
3/4"	3/4" BSP	281111212	16,90
1"	1" BSP	281111616	33,56

Configura tus propias conexiones en *Una sola pieza. Consúltanos.*

Configure your own one piece series fittings. Consult us.

Configurez vos propres connexions en une seule pièce. Sur demande

Configura la tua combinazione personalizzata in prezzo unico. Su richiesta

■ Conexiones Una sola pieza Serie 43

One piece fittings 43 Series
Embouts pré-sertis Série 43
Prezzo unico Serie 43



■ Conexiones Una sola pieza Serie Standard 3SP/4SP/4SH/R12

One piece fittings Standard Serie
Embouts pré-sertis pour Standard
Prezzo unico serie Standard

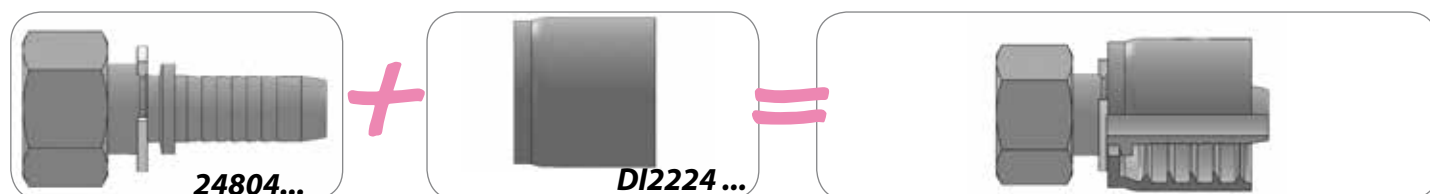

■ Conexiones Una sola pieza R7 / R8 y elastómero malla metálica

Piece fittings R7 / R8 & braid of steel wire
Embouts pré-sertis R7 / R8 et tresse métallique
Prezzo unico serie R7 / R8 e elastomero treccia metallica



■ Conexiones Una sola pieza PTFE liso

One piece fittings for smooth PTFE
Embouts pré-sertis pour PTFE lisse
Prezzo unico serie PTFE liscio



■ Conexiones Una sola pieza PTFE corrugado

One piece fittings for convoluted PTFE
Embouts pré-sertis pour PTFE convolute
Prezzo unico serie PTFE convoluto



Conexiones Serie BW una sola pieza R12 / 4SP / 4SH

One piece fittings BW series R12 / 4SP / 4SH

Embouts pré-sertis Série BW R12 / 4SP / 4SH

Raccordi BW - 1 pezzo R12 / 4SP / 4SH

Macho JIC 37°

JIC 37° male

Mâle JIC 37°

Maschio JIC 37°

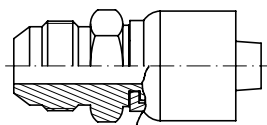

DN	THREAD ROSCA	Part nº Referencia	€
3/4"	1"1/16 12h UNF	681401712	16,54
1"	1"5/16 12h UNF	681402116	23,67

Hembras giratorias rectas JIC 37° doble hexagono

JIC 37° swivel female

Femelle JIC 37°

Femmina diritta JIC 37°

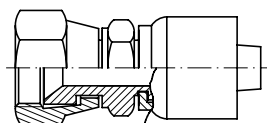

DN	THREAD ROSCA	Part nº Referencia	€
3/4"	1"1/16 12h UNF	682421712	18,68
1"	1"5/16 12h UNF	682422116	26,23

Hembra giratoria recta ORFS asiento plano doble hexagono

ORFS Swivel female straight

Femelle droite ORFS

Femmina diritta ORFS

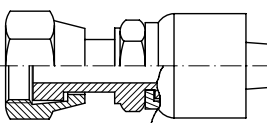

PIPE TUBO	THREAD ROSCA	Part nº Referencia	€
3/4"	1"3/16 12h UNF	689011212	19,65
1"	1"7/16 12h UNF	689011616	26,73

Hembra giratoria 90° ORFS asiento plano

ORFS Swivel female (90° Elbow)

CoUDE 90° femelle ORFS

Femmina 90° ORFS

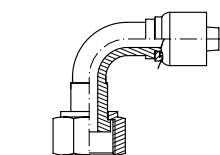

PIPE TUBO	THREAD ROSCA	Part nº Referencia	€
3/4"	1"3/16 12h UNF	689071212	25,57
1"	1"7/16 12h UNF	689071616	36,05

Hembras giratorias 90° JIC 37°

JIC 37° swivel female (90° Elbow)

CoUDE 90° femelle JIC 37°

Femmina gir. 90° JIC 37°

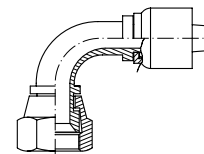

DN	THREAD ROSCA	Part nº Referencia	€
3/4"	1"1/16 12h UNF	681381712	24,29
1"	1"5/16 12h UNF	681382116	32,40

Hembras giratorias 45° JIC 37°

JIC 37° swivel female (45° Elbow)

CoUDE 45° femelle JIC 37°

Femmina gir. 45° JIC 37°

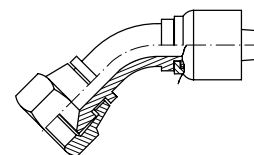

DN	THREAD ROSCA	Part nº Referencia	€
3/4"	1"1/16 12h UNF	681391712	23,07
1"	1"5/16 12h UNF	681392116	32,40

Hembra giratoria 45° ORFS asiento plano

ORFS Swivel female (45° Elbow)

CoUDE 45° femelle ORFS

Femmina 45° ORFS

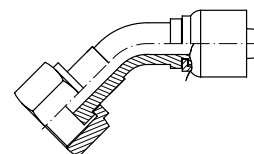

PIPE TUBO	THREAD ROSCA	Part nº Referencia	€
3/4"	1"3/16 12h UNF	689081212	23,62
1"	1"7/16 12h UNF	689081616	32,40

Conexiones Serie BW una sola pieza R12 / 4SP / 4SH

One piece fittings BW series R12 / 4SP / 4SH

Embouts pré-sertis Série BW R12 / 4SP / 4SH

Raccordi BW - 1 pezzo R12 / 4SP / 4SH

Hoses

Flexible hose fittings

Flow measuring

Equipment for flexible hoses

Brida recta SAE 3000 PSI

One piece 3000 PSI SAE Straight Flange/ Code 61

Bride SAE droite série 3000 PSI

Flangia diritta SAE 3000

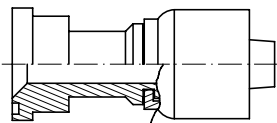

DN	Ø	Part nº Referencia	€
3/4"	38.1	681821212	22,33
1"	44.5	681821616	28,91
1"1/4	50.8	681822020	47,98

Brida recta SAE 6000 PSI

One piece 6000 PSI SAE Straight Flange/ Code 62

Bride SAE droite série 6000 PSI

Flangia diritta SAE 6000

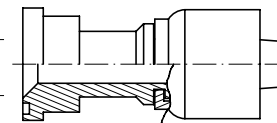

DN	Ø	Part nº Referencia	€
3/4"	41,3	682821212	23,68
1"	47,63	682821616	30,50
1"1/4	53,98	682822020	50,05

Brida a 90° SAE 3000 PSI

One piece 3000 PSI SAE Flange (90° Elbow)/ Code 61

Bride SAE coude 90° série 3000 PSI

Flangia 90° SAE 3000

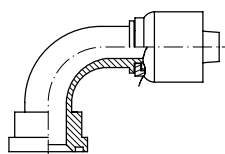

DN	Ø	Part nº Referencia	€
3/4"	38.1	681831212	28,13
1"	44.5	681831616	35,38
1"1/4	50.8	681832020	59,36

Brida a 90° SAE 6000 PSI

One piece 6000 PSI SAE Flange (90° Elbow)/ Code 62

Bride SAE coude 90° série 6000 PSI

Flangia 90° SAE 6000

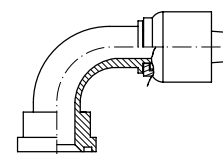

DN	Ø	Part nº Referencia	€
3/4"	41.3	682831212	29,78
1"	47.6	682831616	39,40
1"1/4	54	682832020	65,59

Brida a 45° SAE 3000 PSI

One piece 3000 PSI SAE Flange (45° Elbow)/ Code 61

Bride SAE coude 45° série 3000 PSI

Flangia 45° SAE 3000

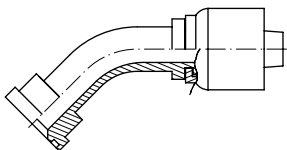

DN	Ø	Part nº Referencia	€
3/4"	38.1	681841212	28,13
1"	44.5	681841616	36,96
1"1/4	50.8	681842020	59,36

Brida a 45° SAE 6000 PSI

One piece 6000 PSI SAE Flange (45° Elbow)/ Code 62

Bride SAE coude 45° série 6000 PSI

Flangia 45° SAE 6000

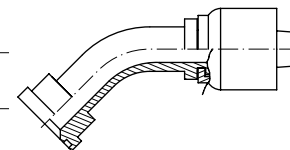

DN	Ø	Part nº Referencia	€
3/4"	41,3	682841212	29,78
1"	47,6	682841616	39,40
1"1/4	54	682842020	66,01

Conexiones Serie BW una sola pieza R12 / 4SP / 4SH

One piece fittings BW series R12 / 4SP / 4SH

Embouts pré-sertis Série BW R12 / 4SP / 4SH

Raccordi BW - 1 pezzo R12 / 4SP / 4SH

Hembras giratorias Métricas cono 24° con junta tórica

Metric swivel female 24° seat with o'ring

Femelle Métrique 24° avec o'ring

Femmina Metrica sede 24° con o'ring

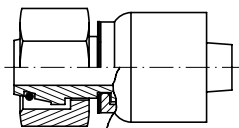

DN	THREAD ROSCA	Part nº Referencia	€
3/4"	M36X2	68204362512	22,46
1"	M42X2	68204423016	32,43
1"1/4	M52X2	68204523820	46,84

Hembras giratorias 45° Métricas cono 24° con junta tórica

Metric swivel female 24° seat with o'ring (45° Elbow)

CoUDE 45° femelle Métrique 24° avec o'ring

Femmina Metrica 45° sede 24° con o'ring

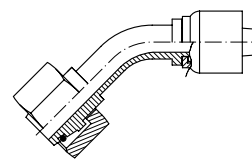

DN	THREAD ROSCA	Part nº Referencia	€
3/4"	M36X2	68206362512	27,03
1"	M42X2	68206423016	35,53
1"1/4	M52X2	68206523820	64,34

Hembras giratorias 90° Métricas cono 24° con junta tórica

Metric swivel female 24° seat with o'ring (90° Elbow)

CoUDE 90° femelle Métrique 24° avec o'ring

Femmina Metrica 90° sede 24° con o'ring

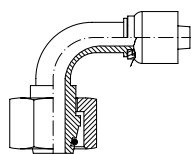

DN	THREAD ROSCA	Part nº Referencia	€
3/4"	M36X2	68205362512	28,16
1"	M42X2	68205423016	38,66
1"1/4	M52X2	68205523820	64,34

Machos fijos Métricos cono 24°

Metric male stud 24° cone

Mâle Métrique cone 24°

Maschio Metrico sede 24°

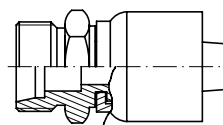

DN	THREAD ROSCA	Part nº Referencia	€
3/4"	M36X2	68203362512	21,10
1"	M42X2	68203423016	28,23

Hembras giratorias rectas BSP cono 60°

BSP Swivel female 60° cone

Femelle tournante gaz cyl BSP 60°

Femmina diritta BSP sede 60°

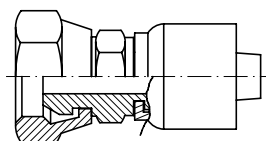

DN	THREAD ROSCA	Part nº Referencia	€
3/4"	3/4" BSP	681101212	17,02
1"	1" BSP	681101616	23,55
1"1/4	1"1/4 BSP	681102020	41,43

Hembras giratorias 45° BSP cono 60°

BSP Swivel female 60° cone (45° Elbow)

Hembras giratorias 45° BSP cono 60°

Femmina a 45° BSP sede 60°

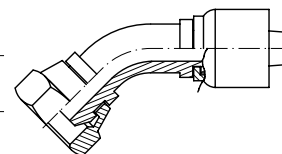

DN	THREAD ROSCA	Part nº Referencia	€
3/4"	3/4" BSP	681081212	22,92
1"	1" BSP	681081616	32,40
1"1/4	1"1/4 BSP	681082020	56,70

Hembras giratorias 90° BSP cono 60°

BSP Swivel female 60° cone (90° Elbow)

CoUDE 90° femelle tournante gaz cyl BSP 60°

Femmina a 90° BSP sede 60°

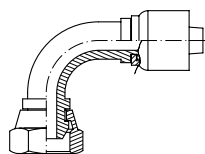

DN	THREAD ROSCA	Part nº Referencia	€
3/4"	3/4" BSP	681071212	22,88
1"	1" BSP	681071616	31,47
1"1/4	1"1/4 BSP	681072020	53,83

Macho BSP cono 60°

BSP Male 60°

Mâle gaz cylindrique BSP 60°

Maschio BSP cilindrico sede 60°

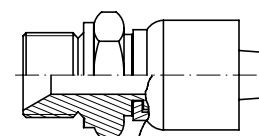

DN	THREAD ROSCA	Part nº Referencia	€
3/4"	3/4" BSP	681121212	17,91
1"	1" BSP	681121616	24,59
1"1/4	1"1/4 BSP	681122020	42,19

INFINITAS SOLUCIONES PARA CONEXIONES DE MANGUERAS:

INFINITE SOLUTIONS FOR CONNECTING HOSES:

■ **Diversos diseños para cumplir las necesidades de conexión**
Several designed connections focused on the specific different requirements

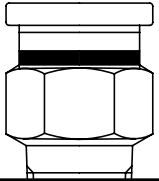
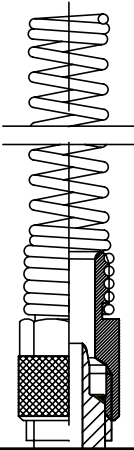
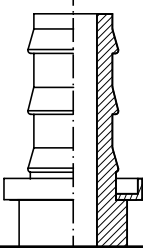
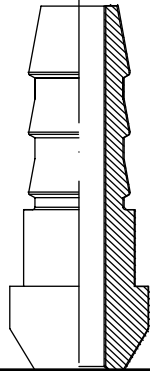
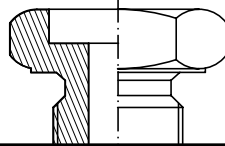
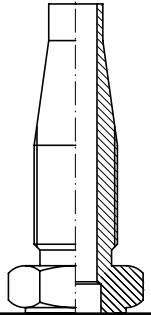
					
PUSH-IN NEUMÁTICO	PUSH-ON NEUMÁTICO	PUSH-ON HIDRÁULICO	BAJA PRESIÓN	SOLDABLE	REUSABLE
NEUMATIC PUSH-IN	NEUMATIC PUSH-ON	HYDRAULIC PUSH-ON	LOW PRESSURE	WELDING	REUSABLE
★	★	★★	★★	★★	★★★

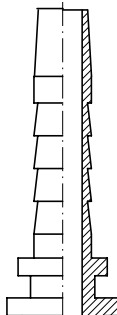
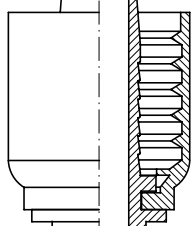
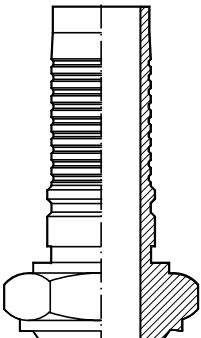
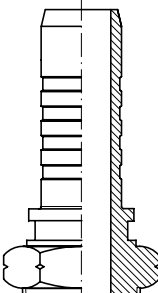
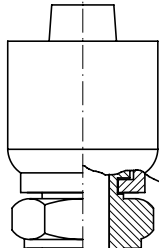
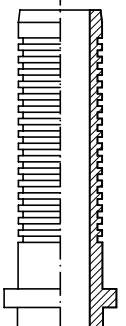
					
ESTÁNDAR	UNA SOLA PIEZA 43 (COMPACTA)	INTERLOCK	BW NO PELAR	UNA SOLA PIEZA BW (COMPACTA)	ALTA PRESIÓN (700BAR)
STANDARD	ONE-PIECE 43 (COMPACT)	INTERLOCK	BW NO SKIVE	ONE PIECE BW (COMPACT)	HIGH PRESSURE (700BAR)
★★★★★		★★★★★★		★★★★★★★	★★★★★★★

Hoses

Flexible hose fittings

Flow measuring

Equipment for flexible hoses

■ BANCO DE PRUEBA BIMAL B1703 FLEX
B1703 FLEX DYNAMIC TEST BENCH



■ BANCO DE PRUEBA BIMAL BI1001
BIMAL BI1001 TEST BENCH



■ BANCO DE PRUEBAS BC/L 2000
BC/L 2000 TEST BENCH



■ BANCO DE PRUEBAS BE 2500 II
BE 2500 II TEST BENCH



Soluciones tecnológicas a medida

BANCOS DE PRUEBAS TEST BENCH

Customized technology solutions

■ BANCO DE PRUEBAS ACUMULADORES
ACCUMULATOR TEST BENCH



■ BANCO DE PRUEBAS MINICENTRAL
MINI POWER PACK TEST BENCH



■ BANCO PARA PRUEBAS DE BOMBAS HIDRÁULICAS
HIGH PERFORMANCE HYDRAULIC TEST BENCH



■ BANCO DE PRUEBAS CONVENCIONAL
CONVENTIONAL TEST BENCH





Gestión intuitiva, rápida, fiable y eficiente

Dicsa presenta su nuevo Asistente Online de Latiguillos con una interfaz sencilla e intuitiva. Con este asistente el cliente puede elaborar de forma rápida y fácil sus ofertas y pedidos, además al tener acceso al plano de las piezas que está confeccionando evita errores de definición o interpretación.

Este asistente está integrado en la página web de Dicsa para que todos los clientes puedan disfrutar esta innovadora herramienta.

Intuitive, fast, reliable and efficient management

Dicsa introduces its new Online Hose Configurator, with an easy-to-use interface. This Configurator enables clients to make purchases quickly and easily. In addition, customers have access to part drawings that they are elaborating, in this way misinterpretation and definition mistakes are avoided.

This Hose Configurator is integrated on Dicsa website so that all customers can enjoy this innovative tool.

Póngase en contacto con nosotros para más información
Contact us for further information

Metrología

Flow measuring

Test du circuit hydraulique

Test per circuiti idraulici

Conexiones Serie Micro-hose

Micro-hose fittings

Embouts manomètres

Raccordi per micro-tubi

98

Racores de control

Test couplings

Prises de pression

Prese di pressione

100

Instrumentos de medición

Pressure and vacuum gauges

Manomètres et vacuomètres

Manometri e vacuometri

103

Medidores de caudal

Flow tester

Débitmètres

Indicatori di flusso

107

3

Conexiones Serie Micro-hose

Micro-hose fittings
 Embouts manomètres
 Raccordi per micro-tubi

- Mangueras para tomas de manómetro / Hoses for check couplings for manometers / Tuyaux capillaires minimes / Tubi per prese di pressione

98



MT010

- Conexiones / Crimp fittings / Embouts à sertir minimes / Raccordi a pressare

98

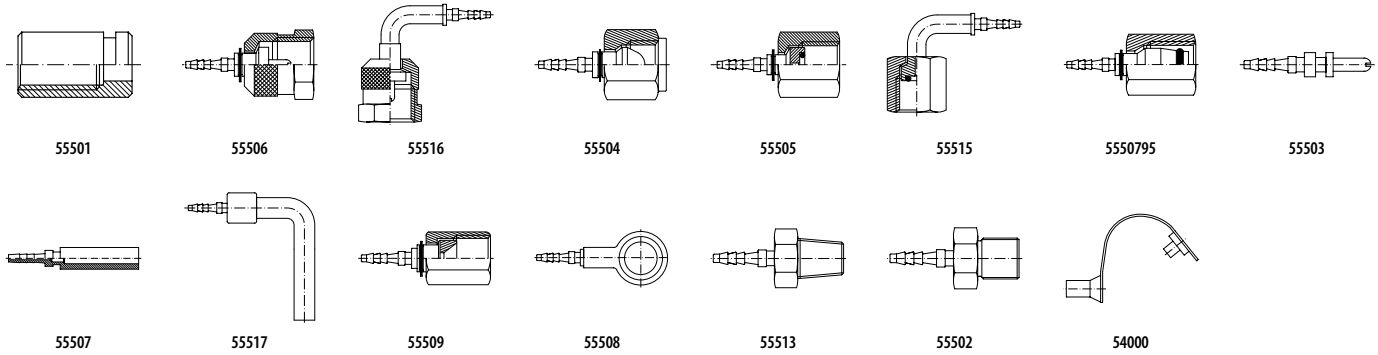

Racores de control

Test couplings
Prises de pression
Prese di pressione

- Tomas de presión 16x1.5 / Check couplings for manometers 16x1.5 / Prises de pression 16x1.5 / Prese di pressione 16x1.5 | 100

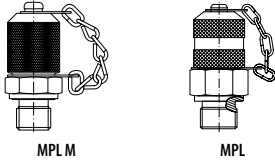

MPLM

MPL

- Tomas de presión 16x2 / Check couplings for manometers 16x2 / Prises de pression 16x2 / Prese di pressione 16x2 | 100

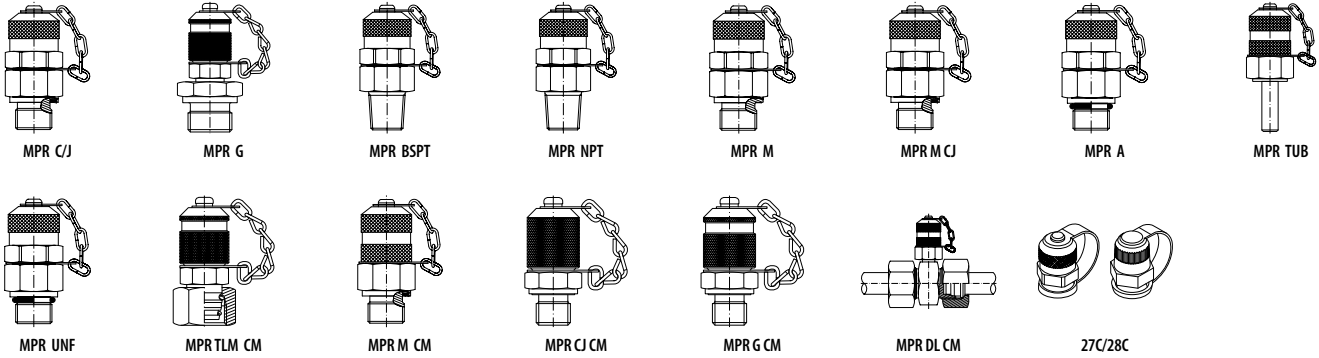

MPR C/J

MPR G

MPR BSPT

MPR NPT

MPR M

MPR M CJ

MPR A

MPR TUB

MPR UNF

MPR TLM CM

MPR M CM

MPR CJ CM

MPR G CM

MPR DL CM

27C/28C

- Tomas de presión manómetros / Accessoires and adaptors / Accessoires et adaptateurs minimes / Accessori e adattatori | 102

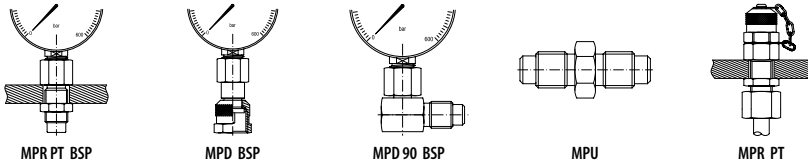

MPR PT BSP

MPD BSP

MPD 90 BSP

MPU

MPR PT

- Válvulas para manómetros / Valves for manometers / Valves pour manètres / Valvole per manometri | 102



FT290

FT291

FT299

Instrumentos de medición

Pressure and vacuum gauges
Manomètres et vacuomètres
Manometri e vacuometri

Manómetros / Pressure gauges / Manomètres / Manometri

| 103



MFI63...V



MFI63...-DB



MFI100...V



MFI100...-DB



MFI63...-DBSB



MFI63...-DBCA



ABRMFI



MFI63...V NPT



MFI63...-DB NPT



MFI100...V NPT



MFI CO



MANDIG63



MANDIG100

Vacuómetros / Vacuum gauges / Vacuomètres / Vacuometri

| 105



VAC6304



MFIVA

Termomanómetros / Temperature- pressure gauge / Thermo-manomètre / Termomanometri

| 105



MFIT63...V



MFIT63..DB

Manovacuómetros / Manovacuumeter / Manovacuumètre / Manovacuumetri

| 105



MFI VAC63...V



MFI VAC63...DB

Maletines de control de presión / Check cases / Équipes de mesure / Valigetta per rilevamento di pressione

| 106



CBOXMED F



CBOX0001



CBOX0003



CBOX0002

Medidores de caudal

Flow tester
Débitmètres
Indicatori di flusso

- Caudalímetros 250 bar / Flow tester 250 bar / Débitmètres 250 bar / Flussostati 250 bar

| 107



WPB3A6H



WPB5A6H



WPB6A6H

- Caudalímetros 300-420 bar / Flow tester 300-420 bar / Débitmètres 300-420 bar / Flussostati 300-420 bar

| 107



FT5758



FT6068



FT5594

Conexiones Serie Micro-hose

Micro-hose fittings
Embouts manomètres
Raccordi per micro-tubi

Mangueras Minimes

"Micro-Hose" hose

Tuyaux Minimes



Micro-tubo per presa di pressione

Ø INNER Ø INT.	Part n° Referencia	€
2	MT01002	3,43

Casquillo manguera Minimes

Micro-hose ferrules

Jupe pour tuyau Minimes

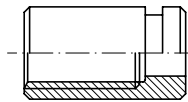

Boccola per Micro-tubo

DN	Ø OUTER Ø EXT.	Ø INNER Ø INT.	Part n° Referencia	€
2	8	5.1	555010100	0,44

Hembra giratoria de control

Check Metric swivel female Micro-hose

Embout femelle tournante de control Métrique Minimes

Presa di pressione femmina

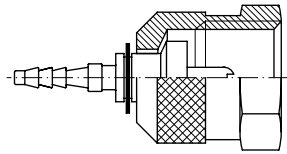

DN	THREAD ROSCA	Part n° Referencia	€
2	M16X1.5	555069521	4,57
2	M16X2	555069523	4,81

Codo 90° hembra giratoria de control

90° Swivel female check coupling

Coude 90° prise de pression femelle tournante

Presa di pressione femmina 90° girevole

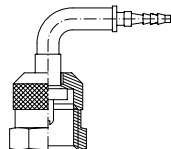

DN	THREAD ROSCA	Part n° Referencia	€
2	M16X2	555169523	35,56

Hembra giratoria recta BSP

Straight swivel female BSP 60° cone Micro-hose

Embout femelle tournante gaz cyl BSP 60° Minimes

Femmina girevole BSP

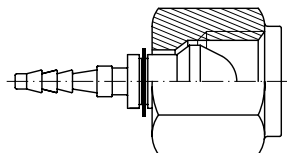

DN	THREAD ROSCA	Part n° Referencia	€
2	1/8" BSP	555040202	4,73
2	1/4" BSP	555040404	4,64
2	3/8" BSP	555040606	6,42

Hembra asiento plano con junta manómetro

Swivel female flat seat with o'ring for manometer Micro-hose

Embout femelle tournante fond plat + o'ring pour manomètre Minimes

Femmina sede piana con o'ring per manometro

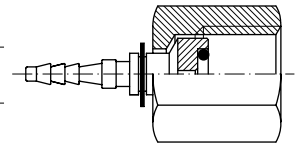

DN	THREAD ROSCA	Part n° Referencia	€
2	1/4" BSP	555050404	4,45
2	1/2" BSP	555050808	7,85

Codo 90° hembra asiento plano con junta manómetro

90° Swivel female flat seat with o'ring for manometer

Coude 90° prise de pression femelle fond plat avec o'ring

Presa di pressione femmina 90° faccia piana con o'ring per manometro

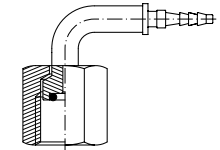

DN	THREAD ROSCA	Part n° Referencia	€
2	1/4" BSP	555150404	35,24

Hembra giratoria Métrica con junta

Metric swivel female with o'ring

Embout femelle tournante Métrique 24° pour raccord de control + o'ring minimes

Femmina Metrica 24° con o'ring

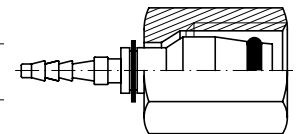

DN	PIPE TUBO	THREAD ROSCA	Part n° Referencia	€
2	6L	M12X1.5	555079510	4,16
2	6S	M14X1.5	555079511	4,16
2	8L	M14X1.5	555079512	4,34
2	8S	M16X1.5	555079523	4,54
2	10L	M16X1.5	555079525	7,42

Macho de control

Straight Micro-hose check male

Embout mâle manomètre

Presa di pressione maschio

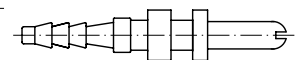

DN	Part n° Referencia	€
2	555030325	2,82

Conexiones Serie Micro-hose

Micro-hose fittings
Embouts manomètres
Raccordi per micro-tubi

Espiga lisa Métrica

Metric standpipe Micro-hose

Embout lisse Métrique Minimess

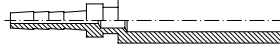

Estremitá tubolare Metrica

DN	PIPE TUBO	Part nº Referencia	€
2	6	555070600	2,73
2	8	555070800	2,62

Espiga a 90° lisa Métrica

90° Metric standpipe Micro-hose

Embout lisse coude 90° Métrique Minimess

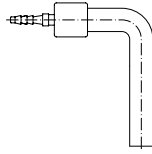

Estremitá tubolare a 90° Metrica

DN	PIPE TUBO	Part nº Referencia	€
2	6	555170600	5,02

Hembra giratoria recta JIC 37°

Straight swivel female JIC 37° Micro-hose

Embout femelle tournante JIC 37° Minimess

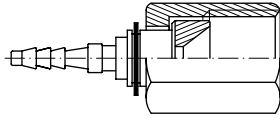

Femmina diritta JIC 37°

DN	THREAD ROSCA	Part nº Referencia	€
2	7/16" 20h UNF	555090700	3,81
2	1/2" 20h UNF	555090800	5,11
2	9/16" 18h UNF	555090900	5,22

Orientable Métrico

Metric Banjo Micro-hose

Embout Banjo Métrique Minimess

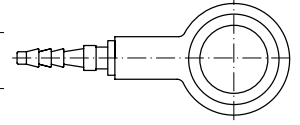

Raccordo ad occhio Metrico

DN	THREAD ROSCA	Part nº Referencia	€
2	M10X1	555081000	6,77

Macho NPT

Male NPT

Mâle NPT

Maschio NPT

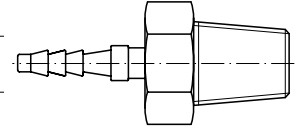

DN	THREAD ROSCA	Part nº Referencia	€
2	1/8" NPT	555130200	4,25

Macho BSP

BSP Male

Mâle BSP

Maschio BSP

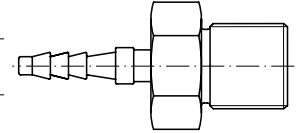

DN	THREAD ROSCA	Part nº Referencia	€
2	1/8" BSP	555020202	4,63
2	1/4" BSP	555020404	14,25

Protector de polvo

Dust protector

Protecteur de poussière

Protezione per polvere

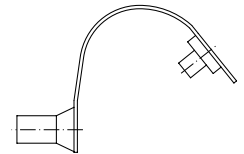

DESCRIPTION DESCRIPCIÓN	Part nº Referencia	€
PLASTIC	54000000P	0,27

Racores de control

Test couplings
Prises de pression
Prese di pressione

Racor de control rosca Métrica DIN 3852 (tapón metálico)

Check coupling male metric thread (metallic cap)

Prise de pression métrique (capuchon métallique)

Prese di pressione Metrica DIN 3852 (tappo metallico)

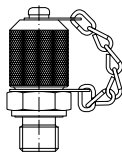

THREAD ROSCA	DESCRIPTION DESCRIPCIÓN	Part nº Referencia	€
M10X1	16x1.5	MPL M 10X1 CM	19,12

Otras figuras, consultar / For other designs, please consult us / Pour d'autres figures, consultez-nous / Per altre figure, vi preghiamo di consultarci

Racor de control rosca BSP (tapón metálico)

Check coupling BSP (metallic cap)

Prise de pression BSP (capuchon métallique)

Prese di pressione BSP (tappo metallico)

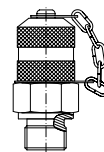

THREAD ROSCA	DESCRIPTION DESCRIPCIÓN	Part nº Referencia	€
1/8" BSP	16x1.5	MPL 1/8 G CM	8,95
1/4" BSP	16x1.5	MPL 1/4 G CM	8,78

Otras figuras, consultar / For other designs, please consult us / Pour d'autres figures, consultez-nous / Per altre figure, vi preghiamo di consultarci

Racor de control rosca BSP con junta (tapón plástico)

Check coupling male thread BSP with captive seal (plastic cap)

Prise de pression avec joint (capuchon plastique)

Prese di pressione BSP con giunta (tappo plastica)



THREAD ROSCA	DESCRIPTION DESCRIPCIÓN	Part nº Referencia	€
1/8" BSP	16x2	MPR 1/8 C/J	6,85
1/4" BSP	16x2	MPR 1/4 C/J	6,70
3/8" BSP	16x2	MPR 3/8 C/J	6,85
1/2" BSP	16x2	MPR 1/2 C/J	7,17

Racor de control rosca NPT (tapón plástico)

Check coupling male thread NPT (plastic cap)

Prise de pression NPTF (capuchon plastique)

Prese di pressione NPTF (tappo plastica)

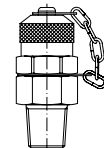

THREAD ROSCA	DESCRIPTION DESCRIPCIÓN	Part nº Referencia	€
1/8" NPT	16x2	MPR 1/8 NPT	7,47
1/4" NPT	16x2	MPR 1/4 NPT	7,47
3/8" NPT	16x2	MPR 3/8 NPT	7,63

Racor de control rosca BSP (tapón plástico)

Check coupling male thread BSP (plastic cap)

Prise de pression (capuchon plastique)

Prese di pressione BSP (tappo plastica)

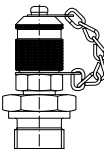

THREAD ROSCA	DESCRIPTION DESCRIPCIÓN	Part nº Referencia	€
1/8" BSP	16x2	MPR 1/8 G	6,93
1/4" BSP	16x2	MPR 1/4 G	6,93
3/8" BSP	16x2	MPR 3/8 G	7,07
1/2" BSP	16x2	MPR 1/2 G	6,83

Racor de control rosca Métrica DIN 3852 (tapón plástico)

Check coupling male metric thread (plastic cap)

Prise de pression métrique (capuchon plastique)

Prese di pressione Metrica DIN 3852 (tappo plastica)

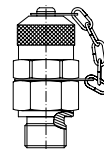

THREAD ROSCA	DESCRIPTION DESCRIPCIÓN	Part nº Referencia	€
M10X1	16x2	MPR M10X1	7,98
M12X1.5	16x2	MPR M12X1.5	7,47
M14X1.5	16x2	MPR M14X1.5	7,47
M16X1.5	16x2	MPR M16X1.5	7,63

Racor de control rosca cónica BSPT (tapón plástico)

Check coupling male BSP tapered (plastic cap)

Prise de pression BSPT (capuchon plastique)

Prese di pressione conica BSPT (tappo plastica)

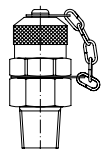

THREAD ROSCA	DESCRIPTION DESCRIPCIÓN	Part nº Referencia	€
1/8" BSPT	16x2	MPR 1/8 BSPT	7,46
1/4" BSPT	16x2	MPR 1/4 BSPT	7,47
3/8" BSPT	16x2	MPR 3/8 BSPT	8,32

Racor de control macho Métrico con junta (Tapón plástico)

Check coupling male metric thread + o'ring (plastic cap)

Prise de pression métrique avec o'ring (capuchon plastique)

Prese di pressione Metrica con o'ring (tappo plastica)

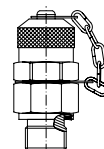

THREAD ROSCA	Part nº Referencia	€
M10x1	MPR M10X1 C/J	6,72
M12x1.5	MPR M12X1.5 C/J	6,72
M14x1.5	MPR M14X1.5 C/J	6,57
M16x1.5	MPR M16X1.5 C/J	6,86

Racores de control

Test couplings
Prises de pression
Prese di pressione

Racor de control rosca Métrica (tapón plástico)

Check coupling male metric thread (plastic cap)

Prise de pression métrique (capuchon plastique)

Prese di pressione Metrica (tappo plastica)



THREAD ROSCA	DESCRIPTION DESCRIPCIÓN	Part nº Referencia	€
M8X1	16x2	MPR A 8X1	7,38
M10X1	16x2	MPR A 10X1	7,38
M10X1.25	16x2	MPR A 10X1.25	7,38

Racor de control tubular Métrico (tapón plástico)

Check coupling male metric tubular (plastic cap)

Prise de pression avec embout lisse (capuchon plastique)

Prese di pressione con tubolare Metrico (tappo plastica)

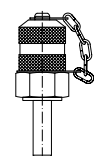

PIPE TUBO	DESCRIPTION DESCRIPCIÓN	Part nº Referencia	€
6	16x2	MPR TUB.6	7,22
8	16x2	MPR TUB.8	7,22
10	16x2	MPR TUB.10	7,22
12	16x2	MPR TUB.12	7,22
15	16x2	MPR TUB.15	7,22

Racor de control rosca SAE - UNF (tapón plástico)

Check coupling male thread UNF (plastic cap)

Prise de pression filetage SAE/UNF (capuchon plastique)

Prese di controllo SAE - UNF (tappo plastica)



THREAD ROSCA	DESCRIPTION DESCRIPCIÓN	Part nº Referencia	€
7/16" 20h UNF	16x2	MPR 7/16 UNF	7,38
1/2" 20h UNF	16x2	MPR 1/2 UNF	7,39
9/16" 18h UNF	16x2	MPR 9/16 UNF	7,38

Racor de control hembra giratoria Métrica con junta (tapón metálico)

Check coupling Metric swivel female + o'ring (metallic cap)

Prise de pression femelle tournante Métrique + o'ring (capuchon métallique)

Prese di pressione femmina girevole Metrica con o'ring (tappo metallico)

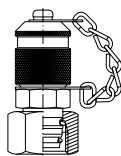

PIPE TUBO	THREAD ROSCA	DESCRIPTION DESCRIPCIÓN	Part nº Referencia	€
6L	M12X1.5	16x2	MPR TLM 6L CM	11,56
8L	M14X1.5	16x2	MPR TLM 8L CM	12,03
10L	M16X1.5	16x2	MPR TLM 10L CM	12,47
12L	M18X1.5	16x2	MPR TLM 12L CM	11,77
15L	M22X1.5	16x2	MPR TLM 15L CM	10,66

Otras medidas, consultar / For other dimensions, please consult us / Pour d'autres dimensions, consultez-nous / Per altre dimensioni, vi preghiamo di consultarci

Racor de control macho Métrico con junta (tapón metálico)

Check coupling metric male + o'ring (metallic cap)

Prise de pression mâle + o'ring (capuchon métallique)

Prese di pressione maschio Metrico con o'ring (tappo metallico)

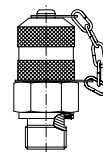

THREAD ROSCA	DESCRIPTION DESCRIPCIÓN	Part nº Referencia	€
M10X1	16x2	MPR M 10X1 CM	8,05
M12X1.5	16x2	MPR M 12X1.5 CM	8,77

Racor de control rosca BSP con junta tórica (tapón metálico)

Check coupling BSP with o'ring (metallic cap)

Prise de pression BSP avec o'ring (capuchon métallique)

Prese di pressione BSP con o-ring (tappo metallico)

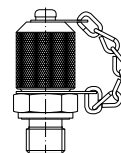

THREAD ROSCA	DESCRIPTION DESCRIPCIÓN	Part nº Referencia	€
1/8" BSP	16x2	MPR 1/8 C/J CM	8,05
1/4" BSP	16x2	MPR 1/4 C/J CM	7,30

Racor de control rosca BSP (tapón metálico)

Check coupling BSP (metallic cap)

Prise de pression BSP (capuchon métallique)

Prese di pressione BSP (tappo metallico)

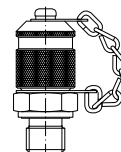

THREAD ROSCA	DESCRIPTION DESCRIPCIÓN	Part nº Referencia	€
1/8" BSP	16x2	MPR 1/8 G CM	8,60
1/4" BSP	16x2	MPR 1/4 G CM	8,60

Racor de control intermedio (tapón metálico)

Halk-way check coupling (metallic cap)

Prise de pression intermédiaire (capuchon métallique)

Prese di pressione intermedio (tappo metallico)

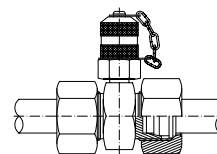

PIPE TUBO	DESCRIPTION DESCRIPCIÓN	Part nº Referencia	€
6L	16x2	MPR DL 6 CM	15,00
8L	16x2	MPR DL 8 CM	14,45
10L	16x2	MPR DL 10 CM	14,94
12L	16x2	MPR DL 12 CM	15,43
15L	16x2	MPR DL 15 CM	16,25

Capuchón protector toma de presión

Protective cap - check coupling for manometer

Capuchon Minimes

Cappuccio di protezione per presa di pressione

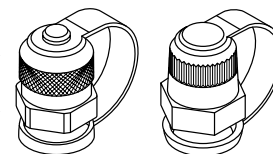

CAPS CAPUCHON	Part nº Referencia	€
CARBON STEEL	27CA0000	2,01
PLASTIC	28CP0000	1,55

Racores de control

Test couplings
Prises de pression
Prese di pressione

Conex. manómetro-pasatabiques BSP

Check coupling BSP bulkhead for manometer

Prise de pression passe cloison sans capuchon

Raccordo Manometro - passaparete maschio BSP

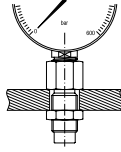

THREAD ROSCA		Part n° Referencia	€
1/4" BSP	M16x2	MPR PT 1/4 BSP	9,82
1/2" BSP	M16x2	MPR PT 1/2 BSP	14,31

Conex. manómetro - toma de control

Check coupling for manometer

Raccord de contrôle direct à manomètre sans capuchon

Raccordo manometro - presa di pressione

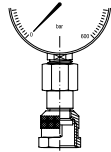

THREAD ROSCA		Part n° Referencia	€
1/4" BSP	M16x2	MPD 1/4 BSP	12,16
1/2" BSP	M16x2	MPD 1/2 BSP	16,30

Conex. manómetro-hembra 90° BSP

Check coupling 90° BSP swivel female for manometer

Raccord de contrôle 90° orientable sans capuchon direct à manomètre

Raccordo manometro - femmina a 90° BSP

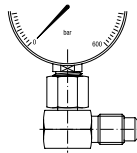

THREAD ROSCA		Part n° Referencia	€
1/4" BSP	M 16x2	MPD 90 1/4 BSP	15,93
1/2" BSP	M 16x2	MPD 90 1/2 BSP	17,37

Protector de manómetro en línea MF-TL recto

Pressure Gauge Protector (in-line) FM-SF straight

Isolateur de manomètre (en ligne) MF-FT droit

Esclusore per manometro in linea M-F gir. diritto



THREAD ROSCA		MAX. PRESSURE (bar) PRESIÓN MAX. (bar)	Part n° Referencia	€
1/4" BSP	1/4" BSPT	350	FT29004	*
1/2" BSP	1/2" BSPT	350	FT29008	*

Ver precios en catálogo componentes / See prices in components catalogue / Voir les prix dans le composant catalogue / Vedere prezzi nel catalogo Componenti

Protector de manómetro en línea MF-TL 90°

Pressure Gauge Protector (in-line) FM-SF 90°

Isolateur de manomètre (en ligne) MF-FT 90°

Esclusore per manometro in linea M-F gir. 90°



THREAD ROSCA		MAX. PRESSURE (bar) PRESIÓN MAX. (bar)	Part n° Referencia	€
1/4" BSP	1/4" BSPT	350	FT29104	*

Ver precios en catálogo componentes / See prices in components catalogue / Voir les prix dans le composant catalogue / Vedere prezzi nel catalogo Componenti

Conex. manómetro M-M

Male-Male check coupling for manometer

Prise de pression manomètre Mâle-Mâle

Adattatore M-M presa di pressione per manometro

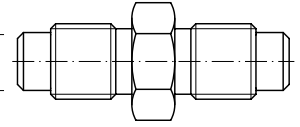

THREAD ROSCA		Part n° Referencia	€
M16X2	M16X1.5	MPU 16X2	19,29
M16X1.5	M16X1.5	MPU 16X1.5	19,03

Conex. Métrica para manómetros

Metric check coupling for manometer

Prise de contrôle métrique pour manomètre

Presa di pressione metrica per manometro

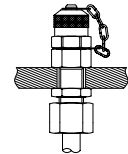

PIPE TUBO	THREAD ROSCA	Part n° Referencia	€
8S	M16X1.5	MPR PT 16X1.5	18,06
10S	M18X1.5	MPR PT 18X1.5	22,55

Adaptador para manómetro en línea MF-TL

Pressure Gauge Adaptor (in-line) FM-SF

Adapteur pour Manomètre (en ligne) MF-FT

Adattatore per manometro in linea M-F gir.



THREAD ROSCA		Part n° Referencia	€
1/4" BSP	1/2" BSPT	FT29942	*
1/4" BSP	1/4" BSPT	FT29944	*

Ver precios en catálogo componentes / See prices in components catalogue / Voir les prix dans le composant catalogue / Vedere prezzi nel catalogo Componenti

Instrumentos de medición

Pressure and vacuum gauges
Manomètres et vacuomètres
Manometri e vacuometri

Hoses

Flexible hose fittings

Flow measuring

Equipment for flexible hoses

Manómetro DN 63 vertical con glicerina (1/4" BSP)

Pressure gauge DN 63 vertical connection with glycerin (1/4" BSP)

Manomètre DN 63 sortie verticale avec glycérine (1/4" BSP)

Manometro DN 63 radiale a bagno di glicerina (1/4" BSP)



THREAD ROSCA	SCALE (bar) ESCALA (bar)	Part nº Referencia	€
1/4" BSP	0-1	MF16304001V	16,00
1/4" BSP	0-2.5	MF163042.5V	16,00
1/4" BSP	0-4	MF16304004V	16,00
1/4" BSP	0-6	MF16304006V	16,00
1/4" BSP	0-10	MF16304010V	16,00
1/4" BSP	0-12	MF16304012V	16,00
1/4" BSP	0-16	MF16304016V	16,00
1/4" BSP	0-20	MF16304020V	16,00
1/4" BSP	0-25	MF16304025V	16,00
1/4" BSP	0-40	MF16304040V	16,00
1/4" BSP	0-60	MF16304060V	16,00
1/4" BSP	0-100	MF16304100V	16,00
1/4" BSP	0-160	MF16304160V	16,00
1/4" BSP	0-250	MF16304250V	16,00
1/4" BSP	0-315	MF16304315V	16,00
1/4" BSP	0-400	MF16304400V	16,00
1/4" BSP	0-600	MF16304600V	16,00
1/4" BSP	0-1000	MF163041000V	17,39

Manómetro DN 63 dorsal con glicerina (1/4" BSP)

Pressure gauge DN 63 rear connection with glycerin (1/4" BSP)

Manomètre DN 63 sortie arrière avec glycérine (1/4" BSP)

Manometro DN 63 assiale flangiato a bagno di glicerina (1/4" BSP)



THREAD ROSCA	SCALE (bar) ESCALA (bar)	Part nº Referencia	€
1/4" BSP	0-1	MF16304001-DB	20,53
1/4" BSP	0-2.5	MF163042.5-DB	20,53
1/4" BSP	0-4	MF16304004-DB	20,53
1/4" BSP	0-6	MF16304006-DB	20,53
1/4" BSP	0-10	MF16304010-DB	20,53
1/4" BSP	0-12	MF16304012-DB	20,53
1/4" BSP	0-16	MF16304016-DB	20,53
1/4" BSP	0-20	MF16304020-DB	20,53
1/4" BSP	0-25	MF16304025-DB	20,53
1/4" BSP	0-40	MF16304040-DB	20,53
1/4" BSP	0-60	MF16304060-DB	20,53
1/4" BSP	0-100	MF16304100-DB	20,53
1/4" BSP	0-160	MF16304160-DB	20,53
1/4" BSP	0-250	MF16304250-DB	20,53
1/4" BSP	0-315	MF16304315-DB	20,53
1/4" BSP	0-400	MF16304400-DB	20,53
1/4" BSP	0-600	MF16304600-DB	20,53

Manómetro DN 100 vertical con glicerina (1/2" BSP)

Pressure gauge DN 100 vertical connection with glycerin (1/2" BSP)

Manomètre DN 100 sortie verticale avec glycérine (1/2" BSP)

Manometro DN 100 radiale a bagno di glicerina (1/2" BSP)



THREAD ROSCA	SCALE (bar) ESCALA (bar)	Part nº Referencia	€
1/2" BSP	0-1	MF110008001V	40,84
1/2" BSP	0-2.5	MF11000802.5V	40,84
1/2" BSP	0-4	MF110008004V	40,84
1/2" BSP	0-6	MF110008006V	40,84
1/2" BSP	0-10	MF110008010V	40,84
1/2" BSP	0-12	MF110008012V	40,84
1/2" BSP	0-16	MF110008016V	40,84
1/2" BSP	0-20	MF110008020V	40,84
1/2" BSP	0-25	MF110008025V	40,84
1/2" BSP	0-40	MF110008040V	40,84
1/2" BSP	0-60	MF110008060V	40,84
1/2" BSP	0-100	MF110008100V	40,84
1/2" BSP	0-160	MF110008160V	40,84
1/2" BSP	0-250	MF110008250V	40,84
1/2" BSP	0-315	MF110008315V	40,84
1/2" BSP	0-400	MF110008400V	40,84
1/2" BSP	0-600	MF110008600V	40,84

Manómetro DN 100 dorsal con glicerina (1/2" BSP)

Pressure gauge DN 100 rear connection with glycerin (1/2" BSP)

Manomètre DN 100 sortie arrière avec glycérine (1/2" BSP)

Manometro DN 100 assiale flangiato a bagno di glicerina (1/2" BSP)



THREAD ROSCA	SCALE (bar) ESCALA (bar)	Part nº Referencia	€
1/2" BSP	0-1	MF110008001-DB	45,89
1/2" BSP	0-2.5	MF1100082.5-DB	45,89
1/2" BSP	0-4	MF110008004-DB	45,89
1/2" BSP	0-6	MF110008006-DB	45,89
1/2" BSP	0-10	MF110008010-DB	45,89
1/2" BSP	0-16	MF110008016-DB	45,89
1/2" BSP	0-25	MF110008025-DB	45,89
1/2" BSP	0-40	MF110008040-DB	45,89
1/2" BSP	0-60	MF110008060-DB	45,89
1/2" BSP	0-100	MF110008100-DB	45,89
1/2" BSP	0-160	MF110008160-DB	45,89
1/2" BSP	0-250	MF110008250-DB	45,89
1/2" BSP	0-315	MF110008315-DB	45,89
1/2" BSP	0-400	MF110008400-DB	45,89
1/2" BSP	0-600	MF110008600-DB	45,89



ENAC

**MANÓMETROS CALIBRADOS
BAJO CONSULTA**

**CALIBRATED MANOMETER
ON REQUEST**

Instrumentos de medición

Pressure and vacuum gauges
Manomètres et vacuomètres
Manometri e vacuometri

Manómetro DN 63 dorsal sin brida, con glicerina (1/4" BSP)

Pressure gauge DN 63 rear connection without flange, with glycerin (1/4" BSP)

Manomètre DN 63 sortie arrière sans bride, avec glycérine (1/4" BSP)

Manometro DN 63 assiale, a bagno di glicerina (1/4" BSP)



THREAD ROSCA	SCALE (bar) ESCALA (bar)	Part n° Referencia	€
1/4" BSP	0-1	MFI6304001-DBSB	17,19
1/4" BSP	0-2.5	MFI63042.5-DBSB	17,19
1/4" BSP	0-4	MFI6304004-DBSB	17,19
1/4" BSP	0-6	MFI6304006-DBSB	17,19
1/4" BSP	0-10	MFI6304010-DBSB	17,19
1/4" BSP	0-12	MFI6304012-DBSB	17,19
1/4" BSP	0-16	MFI6304016-DBSB	17,19
1/4" BSP	0-20	MFI6304020-DBSB	17,19
1/4" BSP	0-25	MFI6304025-DBSB	17,19
1/4" BSP	0-40	MFI6304040-DBSB	17,19
1/4" BSP	0-60	MFI6304060-DBSB	17,19
1/4" BSP	0-100	MFI6304100-DBSB	17,19
1/4" BSP	0-160	MFI6304160-DBSB	17,19
1/4" BSP	0-250	MFI6304250-DBSB	17,19
1/4" BSP	0-315	MFI6304315-DBSB	17,19
1/4" BSP	0-400	MFI6304400-DBSB	17,19
1/4" BSP	0-600	MFI6304600-DBSB	17,19

Consultar disponibilidad. Posibilidad de modelo con DN 100 / Check availability. It is also available with DN 100 / Disponibilité à consulter / Possibilité aussi en DN100 / Richiedere disponibilità / Possibilità del modello con DN 100

Manómetro DN 63 dorsal sin brida con abrazadera, con glicerina (1/4" BSP)

Pressure gauge DN 63 rear connection without flange with clamp, with glycerin (1/4" BSP)

Manomètre DN63 sortie arrière avec glycérine, collier de fixation sans collerette

Manometro DN 63 assiale con collare, con glicerina 1/4" BSP)



THREAD ROSCA	SCALE (bar) ESCALA (bar)	Part n° Referencia	€
1/4" BSP	0-6	MFI6304006-DBCA	20,77
1/4" BSP	0-10	MFI6304010-DBCA	20,77
1/4" BSP	0-16	MFI6304016-DBCA	20,77
1/4" BSP	0-40	MFI6304040-DBCA	20,77
1/4" BSP	0-60	MFI6304060-DBCA	20,77
1/4" BSP	0-100	MFI6304100-DBCA	20,77
1/4" BSP	0-160	MFI6304160-DBCA	20,77
1/4" BSP	0-250	MFI6304250-DBCA	20,77
1/4" BSP	0-400	MFI6304400-DBCA	20,77

Consultar disponibilidad. Posibilidad de modelo con DN 100 / Check availability. It is also available with DN 100 / Disponibilité à consulter / Possibilité aussi en DN100 / Richiedere disponibilità / Possibilità del modello con DN 100

Abrazadera para manómetro DN 63 / DN 100 dorsal

DN 63 / DN100 rear connection pressure gauge clamp

Collier pour manomètre DN 63 / DN100 sortie arrière

Collare per manometro DN 63 / DN100 assiale flangiato



DESCRIPTION DESCRIPCIÓN	Part n° Referencia	€
CLAMP (63mm)	ABRMFI63	3,58
CLAMP (100mm)	ABRMFI100	5,01

Consultar disponibilidad. Posibilidad de modelo con DN 100 / Check availability. It is also available with DN 100 / Disponibilité à consulter / Possibilité aussi en DN100 / Richiedere disponibilità / Possibilità del modello con DN 100

Manómetro DN 63 vertical con glicerina (1/4" NPT)

Pressure gauge DN 63 vertical connection with glycerin (1/4" NPT)

Manomètre DN 63 sortie verticale avec glycérine (1/4" NPT)

Manometro DN 63 radiale a bagno di glicerina (1/4" NPT)



THREAD ROSCA	SCALE (bar) ESCALA (bar)	Part n° Referencia	€
1/4" NPT	0-10	MFI6304010V NPT	16,47
1/4" NPT	0-16	MFI6304016V NPT	16,47
1/4" NPT	0-25	MFI6304025V NPT	16,47
1/4" NPT	0-60	MFI6304060V NPT	16,47
1/4" NPT	0-160	MFI6304160V NPT	16,47
1/4" NPT	0-250	MFI6304250V NPT	16,47
1/4" NPT	0-400	MFI6304400V NPT	16,47

Manómetro DN 63 dorsal con glicerina (1/4" NPT)

Pressure gauge DN 63 rear connection with glycerin (1/4" NPT)

Manomètre DN 63 sortie arrière avec glycérine (1/4" NPT)

Manometro DN 63 assiale flangiato a bagno di glicerina (1/4" NPT)



THREAD ROSCA	SCALE (bar) ESCALA (bar)	Part n° Referencia	€
1/4" NPT	0-10	MFI6304010-DB NPT	21,13
1/4" NPT	0-16	MFI6304016-DB NPT	21,13
1/4" NPT	0-25	MFI6304025-DB NPT	21,13
1/4" NPT	0-60	MFI6304060-DB NPT	21,13
1/4" NPT	0-160	MFI6304160-DB NPT	21,13
1/4" NPT	0-250	MFI6304250-DB NPT	21,13
1/4" NPT	0-400	MFI6304400-DB NPT	21,13

Consultar disponibilidad. Posibilidad de modelo con DN 100 / Check availability. It is also available with DN 100 / Disponibilité à consulter / Possibilité aussi en DN100 / Richiedere disponibilità / Possibilità del modello con DN 100

Manómetro DN 100 vertical con glicerina (1/2" NPT)

Pressure gauge DN 100 vertical connection with glycerin (1/2" NPT)

Manomètre DN 100 sortie verticale avec glycérine (1/2" NPT)

Manometro DN 100 radiale a bagno di glicerina (1/2" NPT)



THREAD ROSCA	SCALE (bar) ESCALA (bar)	Part n° Referencia	€
1/2" NPT	0-10	MFI10008010V NPT	40,84
1/2" NPT	0-25	MFI10008025V NPT	40,84
1/2" NPT	0-60	MFI10008060V NPT	40,84
1/2" NPT	0-250	MFI10008250V NPT	40,84
1/2" NPT	0-400	MFI10008400V NPT	40,84
1/2" NPT	0-600	MFI10008600V NPT	40,84

Manómetro de colores dorsal (1/8" BSPT)

Pressure gauge in colours rear connection (1/8" BSPT)

Manomètre à couleurs sortie arrière avec glycérine (1/8" BSPT)

Manometro a colori assiale flangiato (1/8" BSPT)



SCALE (bar) ESCALA (bar)	Part n° Referencia	€
0-6	MFI CO 06	6,61

Instrumentos de medición

Pressure and vacuum gauges
Manomètres et vacuomètres
Manometri e vacuometri

Hoses

Flexible hose fittings

Flow measuring

Equipment for flexible hoses

Manómetro digital DN63 vertical (1/4" BSP)

Pressure gauge DN63 rear connection with glycerin (1/4" BSP)

Manomètre digital DN 63 sortie verticale (1/4" BSP)

Manomètre digital DN63 (1/4" BSP)



THREAD ROSCA	SCALE (bar) ESCALA (bar)	Part n° Referencia	€
1/4" BSP	0-600	MANDIG63V	234,73

Manómetro digital DN100 vertical (1/2" BSP)

Digital pressure gauge DN100 vertical connection (1/2" BSP)

Manomètre digital DN 100 sortie verticale (1/2" BSP)

Manomètre digital DN100



THREAD ROSCA	SCALE (bar) ESCALA (bar)	Part n° Referencia	€
1/2" BSP	0-1000	MANDIG100V	722,90

Vacuómetro DN 63 con glicerina (1/4" BSP)

Vacuum gauge DN 63 with glycerin (1/4" BSP)

Vacuomètre DN 63 avec glycerine (1/4" BSP)

Vacuometro DN 63 a bagno di glicerina (1/4" BSP)



SCALE (bar) ESCALA (bar)	Part n° Referencia	€
-1-0	VAC6304-01I	16,83

Vacuómetro de colores dorsal (1/8" BSP)

Vacuum gauges in colours rear connection (1/8" BSP)

Vacuomètre à couleurs sortie arrière (1/8" BSP)

Vacuometro a colori assiale flangiato (1/8" BSP)



SCALE (bar) ESCALA (bar)	Part n° Referencia	€
-1-0	MFI VA 01	6,49

Termomanómetro DN 63 vertical (1/4" BSP)

Temperature- pressure gauge DN 63 vertical connection (1/4" BSP)

Thermo-manomètre DN63 sortie vertical (1/4" BSP)

Termomanometro DN 63 verticale (1/4" BSP)



THREAD ROSCA	SCALE (bar) ESCALA (bar)	Part n° Referencia	€
1/4" BSP	0-4	MFIT6304004V	29,72
1/4" BSP	0-16	MFIT6304016V	29,72
1/4" BSP	0-40	MFIT6304040V	29,72

Temp: 0-120°C

Termomanómetro DN 63 dorsal (1/4" BSP)

Temperature- pressure gauge DN 63 rear connection (1/4" BSP)

Thermo-manomètre DN63 sortie arrière (1/4" BSP)

Termomanometro DN 63 assiale (1/4" BSP)



THREAD ROSCA	SCALE (bar) ESCALA (bar)	Part n° Referencia	€
1/4" BSP	0-4	MFIT6304004-DB	28,29
1/4" BSP	0-16	MFIT6304016-DB	28,29
1/4" BSP	0-40	MFIT6304040-DB	28,29

Temp: 0-120°C

Manovacuómetro DN 63 vertical con glicerina (1/4" BSP)

Manovacuumeter DN 63 vertical connection with glycerin (1/4" BSP)

Manovacuumètre DN 63 sortie verticale avec glycérine (1/4" BSP)

Manovacuumetro DN 63 verticale con glicerina (1/4" BSP)



THREAD ROSCA	SCALE (bar) ESCALA (bar)	Part n° Referencia	€
1/4" BSP	-1,+3	MFIVAC6304003V	17,91
1/4" BSP	-1,+5	MFIVAC6304005V	17,91
1/4" BSP	-1,+15	MFIVAC6304015V	17,91

Manovacuómetro DN 63 dorsal con glicerina (1/4" BSP)

Manovacuumeter DN 63 rear connection with glycerin (1/4" BSP)

Manovacuumètre DN 63 sortie arrière avec glycérine (1/4" BSP)

Manovacuumetro DN 63 assiale con glicerina (1/4" BSP)



THREAD ROSCA	SCALE (bar) ESCALA (bar)	Part n° Referencia	€
1/4" BSP	-1,+3	MFIVAC6304003-DB	22,56
1/4" BSP	-1,+5	MFIVAC6304005-DB	22,56
1/4" BSP	-1,+15	MFIVAC6304015-DB	22,56

Instrumentos de medición

Pressure and vacuum gauges
Manomètres et vacuomètres
Manometri e vacuometri

Maletín medida de presión (0 manómetros)

Check cases (0 manometer)

Coffre de mesure (0 manomètre)

Valigetta misurazione di pressione (0 manometro)



SIZE TAMAÑO	SCALE (bar) ESCALA (bar)	Part n° Referencia	€
320x280x119	-	CBOXMEDF	93,01

Maletín dos manómetros + accesorios tipo 1

Check case 2 manometers + accessories type 1

Coffre 2 manomètres + accessoires type 1

Valigetta con due manometri + accessori tipo 1



SIZE TAMAÑO	SCALE (bar) ESCALA (bar)	Part n° Referencia	€
320X280X119	0-160; 0-315	CBOX0001	247,63

Maletín un manómetro digital + accesorios tipo 2

Check case 1 digital manometer + accessories type 2

Coffre 1 manomètre digital + accessoires type 2

Valigetta con uno manometri digitale+ accessori tipo 2



SIZE TAMAÑO	SCALE (bar) ESCALA (bar)	Part n° Referencia	€
320x280x119	0-1000	CBOX0003	1.138,50

Maletín tres manómetros + accesorios tipo 2

Check case 3 manometers + accessories type 2

Coffre 3 manomètres + accessoires type 2

Valigetta con tre manometri + accessori tipo 2



SIZE TAMAÑO	SCALE (bar) ESCALA (bar)	Part n° Referencia	€
320x280x119	0-100; 0-250; 0-400	CBOX0002	339,02



CBOX0001



CBOX0002



CBOX0003

2 MANÓMETROS 1/4:

0-160
0-315

3 MANÓMETROS 1/4

0-100
0-250
0-400

1 MANÓMETROS DIG.

0-1000

ACCESORIOS TIPO 1:

1 MPR 1/4 C/J
1 MPR 3/8 C/J
1 MPR 1/4 NPT
1 MPR A 10X1
1 MPD 1/4 BSP
1 CAPUCHÓN ACERO
1 MPD 90 1/4 BSP
1 LATIGUILLO MINIMEX TL-TL 16X2 1.5 MTS

ACCESORIOS TIPO 2:

1 MPR 1/4 C/J
1 MPR 3/8 C/J
1 MPR 1/4 NPT
1 MPR A 10X1
1 MPD 1/4 BSP
1 MPD 1/2 BSP
1 CAPUCHÓN ACERO
1 MPR PT 1/4 BSP
1 LATIGUILLO MINIMEX TL-TL 16X2 1 MTS
1 LATIGUILLO MINIMEX TL-TL 16X2 2 MTS
1 MPR 7/16 UNF
1 MPR 9/16 UNF
1 MPR TLM 122 CM
1 MPR 3/8 NPT

Medidores de caudal

Flow tester
Débitmètres
Indicatori di flusso

Hoses

Flexible hose fittings

Flow measuring

Equipment for flexible hoses

Caudalímetro 250 bar - Tipo 3 - 3/4" BSP

Flow tester type 3-3/4" BSP

Débitmètre 250 bar type 3-3/4" BSP

Flussostato 250 bar tipo 3-3/4" BSP



SCALE (l/min) ESCALA (l/min)	Part nº Referencia	€
0-56	WPB3A6HT15	1.248,36

Caudalímetro 250 bar - Tipo 6 - 1 1/4" BSP

Flow tester type 6-1 1/4"

Débitmètre 250 bar type 6-1 1/4" BSP

Flussostato 250 bar tipo 6-1 1/4" BSP



SCALE (l/min) ESCALA (l/min)	Part nº Referencia	€
20-280	WPB5A6HW75	*

Caudalímetro 250 bar - Tipo 5 - 1 1/2" BSP

Flow tester type 5-1 1/2" BSP

Débitmètre 250 bar type 5-1 1/2" BSP

Flussostato 250 bar tipo 5-1 1/2" BSP



SCALE (l/min) ESCALA (l/min)	Part nº Referencia	€
0-550	WPB5A6HY99	*

Caudalímetro 420 bar - Tipo 57 - 3/4" BSP

Flow tester 420 bar Type 57 - 3/4" BSP

Débitmètre 420 bar Type 57 - 3/4" BSP

Flussostato 420 bar Tipo 57 - 3/4" BSP



SCALE (l/min) ESCALA (l/min)	Part nº Referencia	€
2-30	FT5758-01	1.504,36
2-60	FT5758-02	1.643,66
4-120	FT5758-03	1.786,05

Caudalímetro 350 bar - Tipo 60 - 1" 1/2 BSP

Flow tester 350 bar Type 60 - 1" 1/2 BSP

Débitmètre 350 bar Type 60 - 1" 1/2 BSP

Flussostato 350 bar Tipo 60 - 1" 1/2 BSP



SCALE (l/min) ESCALA (l/min)	Part nº Referencia	€
10-200	FT6068-01	3.024,21
20-400	FT6068-03	3.776,39

Caudalímetro 420 bar - con caja - 1" BSP

Flow tester 420 bar with box - 1" BSP

Débitmètre 420 bar avec boîte - 1" BSP

Flussostato 420 bar con cassa - 1" BSP



SCALE (l/min) ESCALA (l/min)	Part nº Referencia	€
10-120	FT5594-03	4.225,22
10-200	FT5594-09	4.339,75

Máquinas tratamiento tubo flexible

Equipment for flexible hoses

Machines pour le montage des flexibles

Macchine per l'assemblaggio di tubi flessibili

Máquinas tratamiento tubo flexible

Equipment for flexible hoses

Machines pour le montage des flexibles

Macchine per l'assemblaggio di tubi flessibili

110

4

Máquinas para flexibles. Prensas manuales

Manual equipment for hose assembly
 Machines pour flexibles. Presses manuelles
 Macchine per tubi flessibili. Presse manuali

■ MANGUERA HIDRÁULICA · HYDRAULIC HOSES · TUYAU HYDRAULIQUE · TUBO FLESSIBILE

 100 t
  +20 mm
  59 mm



1" 3SP

PM16-8J

 120 t
  +20 mm
  65 mm



1" 4SP

PM18F-9J

 140 t
  +25 mm
  110 mm



1" 1/4 4SP

PM22-9J

 450 bar



1/4" 1" 2SP
1/4" 3/4" 4SP

PHM2 12
PHM2 16

 80 t
  +20 mm
  59 mm

 30 kg.



1" 2SP
3/4" 4SP
1/2" 6SP

PM-18 6J

BOMBA NEUMÁTICA
BAJO CONSULTA
PNEUMATIC PUMP
ON REQUEST



■ BAJA PRESIÓN · LOW PRESSURE · BASSE PRESSION · BASSA PRESSIONE

 50-60kg
  +21 mm
  10-13-16 mm



PBPH25

■ FREÓN

 220 bar
  Freon 5/8



Garras para manómetros
Manometres dies

V001040

Máquinas para flexibles. prensas eléctricas

Electrical equipment for hose assembly
 Machines pour flexibles. Presse électrique
 Macchine per tubi flessibili. Presse elettrica

SE 28 5J / 10J



PE38-12J



PE58-14J



Taller móvil para montaje de latiguillos
 Mobile workshop for hose assembly
 Atelier mobile pour flexibles
 Officina mobile per assemblaggio tubi flessibili



Battery · Bateria



325 x 165 x 238 / 26,5 kg

Accesorios para prensas · Accessories for crimpers · Accessoires pour presse · Accessori per presse



Hoses

Flexible hose fittings

Flow measuring

Equipment for flexible hoses

Máquinas para flexibles. Prensas eléctricas de producción

High capacity equipment for hose assembly

Machines pour flexibles. Presse électrique de production

Macchine per tubi flessibili. Presse elettriche da produzione

HM 225

160 t
+40 mm 110 mm



Sin grasa
Greaseless

1" 1/4 4SP
2" Indus.

P CRIMP 480

480 t
+85 mm 212 mm



3" 6SP
5" Indus.

Máquinas para flexibles. Expositor y Portarrollos

Machines for flexibles. Exhibition & Roll-Holder

Machines pour flexibles. Présentoirs et dévidoirs

Macchine per tubi flessibili. Espositori e portarrotoli

EXL

Expositor manguera / Hose Assembly display



Cada nivel: max. 25 kg
Total max. capacidad: 250 kg

PRO7

Expositor manguera / Hose display



Carga máx. recomendada /bandeja: 70 Kg.
Carga total recomendada: 490 Kg.

PCM3

Expositor de carretes / Display for reels



Otras máquinas, consultar · Other equipment, on request · Autres machines, sur demande · Altre macchine, su richiesta

PMT2

Peladora Manual (interna / externa)

Manual hose skiving machine
(internal / external)



Hasta 2"

MESASOLDADURA165 (Welding table)



0.40 Kw 220 kg.

Máquinas para flexibles. Cortadoras

Machines for flexibles. Cutting machines
 Machines pour flexibles. Tronçonneuses
 Macchine per tubi flessibili. Taglierine

Hoses

Flexible hose fittings

Flow measuring

Equipment for flexible hoses

■ CHMT-20

 Ø Max. 50mm  2,2 Kw
 Ø 250 mm
 1" 1/4 4SP

■ CHM4-32D

 Ø Max. 75mm  3 Kw
 Ø 250 mm
 2" 4SP

■ CHMT-55

 Ø Max. 80mm  5,5 Kw
 Ø 400 mm
Contadores incluidos
Includes digital counters
 2" 6SP

■ TS76

 Ø 125mm  9 Kw
 Ø 520 mm
 3" 6SP
Accionamiento neumático
Hydraulic operation

■ MN500SW

 1000 c/h. **Corte automático**
Automatic cutting
 3/4" 2SP

■ MN450

 2000 c/h. **Corte automático**
Automatic cutting
 Hasta 3/4" sin malla metálica

■ UC34

 3/4"

■ TP50

Para metal corrugado con una malla
For metal corrugated hoses with one wire braid
 Hasta 2"

■ CON 125 / CON 320

↔ Ø min. 15 mm - max. 125 mm ↔ Ø min. 6 mm - max. 70 mm

AG000



Contador manguera
Hose measuring device

■ HOSE CUTTING BLADES



Disponibles recambios de discos
Available spare parts cutting

Peladoras

Skiving machines
Dénudeuses
Spellatubi

R.P.M. 300 ⚡ 0.75 Kw AIR Max. 7 Bar



* con mueble
* with furniture

■ PBC-32 (standard option)



Una cuchilla
One cutter

■ PBCM-32 (MS option)



Cambio rápido de útiles
Skiver with quick change tooling

Cuchilla doble para cualquier diámetro de manguera
Double cutter for any hose diameter

■ PB-32

R.P.M. 300 ⚡ 0.75 Kw 2"



Peladora sin mueble hasta 2"
Skiving machine up to 2"

Útiles para las máquinas
Tools
Accessoires Machines
Utensili per macchine

* Opcional
* Optional



Mordaza neumática
Pneumatic clamp



Portaherramientas
Tool holder

* Opcional
* Optional



Mueble portaherramientas
Tool holder cabinet

Máquinas para flexibles. Otras máquinas

Machines for flexibles. Other equipment
 Machines pour flexibles. Autres
 Macchine per tubi flessibili. Altre macchine

Hoses

Flexible hose fittings

Flow measuring

Equipment for flexible hoses

■ BE 2500

0-2500 bar



Optional Digital pressure control available

3/16" hasta 2"

Banco de pruebas para mangueras de alta presión
 Static High Pressure Hose Test Bench

■ CK 50

7 Bar AIR



1/4" hasta 2"

Espumas de multiples tamaños
 Multiples foam sizes

■ RG10

7 Bar AIR

Max. lenght. 20 m



hasta 2" ID

Máquina de limpieza de mangueras con dos cabezales de lavado
 Hose cleaning machine with two flushing heads

■ RG2

7 Bar AIR

Max. lenght. 2,5 m



hasta 1 1/4" ID

Máquina limpieza de mangueras móvil
 Mobile hose cleaning machine

■ MMT050

Ø min. 11,5 mm - max. 100 mm



Marcadora manual
 Manual roll marking machine

■ MNT 50

Ø min. 11,5 mm - max. 85 mm



Marcadora neumática
 Pneumatic marking machine

■ IRT50

Ø 50mm

straight, 45°, 90°



Introducor rápido para racores
 Manual niple inserter

MÁQUINAS TRATAMIENTO TUBO FLEXIBLE Y TUBO RÍGIDO

Processing machine for flexible hoses & rigid pipes



Datos siempre actualizados en nuestra web
Information always updated on our website

www.dicsaes.com

Flexibles industriales

*Industrial Flexible Hoses
& Fittings*

Flexibles industriali

*Tubi flessibili e raccordi
industriali*

INDUS TrAle®

Industrial Flexible Hoses & Fittings



Mangueras industriales

Industrial hoses
Tuyaux industriels
Tubi industriali

1

Racores industriales

Industrial fittings
Raccords industriels
Raccordi industriali

2

Inox Corrugado

Stainless steel hose, welding fittings and flanges
Tuyau Inox, raccords et brides à souder
Tubi Inox, raccordi e flange a saldare

3

Baja presión

Low pressure
Basse pression
Tubi a bassa pressione

4

Aire acondicionado

Air conditioning hoses and fittings
Climatisation
Aria condizionata

5

Mangueras industriales

Industrial hoses

Tuyaux industriels

Tubi industriali

Manguera industrial INDUSTRΔle

Industrial hoses INDUSTRΔle

Tuyaux industriels INDUSTRΔle

Tubi industriali INDUSTRΔle

1

INDUS TrAle[®]

Manguera industrial INDUSTrAle

Industrial hoses INDUSTrAle
Tuyaux industriels INDUSTrAle
Tubi industriali INDUSTrAle

INDUS TrAle®

- Mangueras aire-agua / Air-water hoses / Tuyaux air-eau / Tubo acqua-aria | 123



M8000

MM20

MI0101

MF80

MA1220

MI0102

MI0103

- Mangueras hidrocarburos / Hydrocarbon hoses / Tuyaux pour hydrocarbures / Tubo idrocarburi | 124



MI0401

MI0404

MI0403

M7000

ML7010

MSB21

- Mangueras soldadura / Welding hoses / Tuyaux pour soudure / Tubi saldatura | 125



MI0603

MI0601

MI0602

- Mangueras abrasivas / Abrasive hoses / Tuyaux abrasifs / Tubo abrasivo | 126



MI0301

MI0302

MI0303

MI0305

- Mangueras productos químicos / Chemical product hoses / Tuyaux pour produits chimiques / Tubo prodotti chimici | 126



MI0701

MI0702

- Mangueras alimentarias / Food hoses / Tuyaux alimentaires / Tubo alimentare | 127



MAS

MI0205

MI0206

Manguera industrial INDUSTrAle

Industrial hoses INDUSTrAle
Tuyaux industriels INDUSTrAle
Tubi industriali INDUSTrAle

INDUS TrAle®

Industrial hoses

Industrial fittings

Stainless steel hose, welding fittings and flanges

Low pressure

Air conditioning hoses and fittings

Ariaform aire comprimido y agua-impulsión

Compressed Air hose - impulsion

Ariaform refoulement air comprimé et de l'eau



Tubo aria compressa e mandata

Ø INNER Ø INT.	Ø outer Ø ext	Part n° Referencia	€
6	14	M80000614	2,54
8	15	M80000817	2,77
10	17	M80001017	3,12
13	21	M80001321	4,82
16	26	M80001626	6,07
19	29	M80001929	6,70

Polivalente serie continua

Multi-function. Continuous serie

Tuyau polyvalent huiles/eau



Polivalente. Serie continua

Ø INNER Ø INT.	Ø outer Ø ext	Part n° Referencia	€
8	15	MM2008	3,38
10	17	MM2010	4,44
13	21	MM2013	5,38
16	24	MM2016	6,81
19	27	MM2019	8,13
25	34	MM2025	12,32
32	44	MM2032	22,44
38	50	MM2038	27,76

Aspiración agua 10 bar

Water suction hose 10 bar

Tuyau aspiration eau 10 bar



Tubo aspirazione acqua 10 bar

Ø INNER Ø INT.	Ø outer Ø ext	Part n° Referencia	€
25	35	MI01011025	25,28
30	40	MI01011030	28,10
32	42	MI01011032	29,48
35	45	MI01011035	30,63
38	48	MI01011038	32,37
40	50	MI01011040	32,79
51	62	MI01011051	39,51
60	71	MI01011060	47,50
63,5	76	MI01011063.5	49,84
70	82	MI01011070	56,51
76	88	MI01011076	62,09
80	92	MI01011080	65,87
90	102	MI01011090	78,91
102	117	MI01011102	84,31

Fumigación serie continua

Fumigation hose. Continous serie

Tuyau fumigation



Fumigazione. Serie continua

Ø INNER Ø INT.	Ø outer Ø ext	Part n° Referencia	€
12,5	21	MF8012	8,88

Aire comprimido y agua - impulsión

Compressed air and water impulsion

Air comprimé et eau- impulsion



Aria compressa e acqua - mandata

Ø INNER Ø INT.	Ø outer Ø ext	Part n° Referencia	€
25	35	MA122025	12,22
32	45	MA122032	18,72
38	51	MA122040	28,76
51	64	MA122051	37,85
63.5	79.5	MA122063	69,87
75	91	MA122075	77,63

Vapor 18 bar, limpieza industrial 210°C

Steam hose 18 bar, industrial cleaning, 210°C

Tuyau vapeur 18 bar, nettoyage industriel 210°C



Vapore 18 bar, lavaggio industriale 210°C

Ø INNER Ø INT.	Ø outer Ø ext	Part n° Referencia	€
13,5	24,5	MI01021713	24,72
18	31	MI01021719	29,57
25	38	MI01021725	34,44
32	45	MI01021732	57,84
38	53	MI01021738	66,16
50,8	67	MI01021751	84,25
76,2	93	MI01021776	210,47

Vapor 7 bar EPDM blanco FDA - limpieza industrial

Steam hose 7 bar, white EPDM FDA industrial cleaning

Tuyau vapeur 7 bar EPDM blanc FDA nettoyage industriel



Tubo vapore 7 bar EPDM bianco FDA pulizia industriale

Ø INNER Ø INT.	Ø outer Ø ext	Part n° Referencia	€
13	23	MI01030713	20,48
16	26	MI01030716	22,70
19	31	MI01030719	27,92
25	37	MI01030725	33,15

Manguera industrial INDUSTRΔle

Industrial hoses INDUSTRΔle
Tuyaux industriels INDUSTRΔle
Tubi industriali INDUSTRΔle

INDUS TrΔle®

Manguera hidrocarburos 10 bar impulsión

Hydrocarbons hose 10 bar discharge

Tuyau pour hydrocarbures 10 bar impulsion



Tubo idrocarburi 10 bar -mandata

Ø INNER Ø INT.	Ø outer Ø ext	Part n° Referencia	€
6	12	MI04011006	2,95
8	14	MI04011008	3,76
10	17	MI04011010	4,57
13	20	MI04011013	5,89
16	23	MI04011016	7,17
19	27	MI04011019	9,25
25	35	MI04011025	14,22
32	42	MI04011032	22,36

Manguera hidrocarburos 20 bar impulsión

Hydrocarbons hose 20 bar discharge

Tuyau pour hydrocarbures 20 bar impulsion



Tubo idrocarburi 20 bar -mandata

Ø INNER Ø INT.	Ø outer Ø ext	Part n° Referencia	€
6	12	MI04042006	3,41
8	15	MI04042008	4,45
10	17	MI04042010	5,09
13	20	MI04042013	6,36
16	24	MI04042016	8,32
19	28	MI04042019	10,75
25	35	MI04042025	15,54
32	42	MI04042032	24,67

Manguera hidrocarburos 10 bar aspiración

Hydrocarbons hose 10 bar intake

Tuyau pour hydrocarbures 10 bar aspiration



Tubo aspirazione 10 bar idrocarburi

Ø INNER Ø INT.	Ø outer Ø ext	Part n° Referencia	€
19	29	MI040310019	22,25
25	35	MI040310025	23,88
32	42	MI040310032	28,51
38	48	MI040310038	33,76
51	61,8	MI040310051	39,32
63	75	MI040310063	54,01
76	89	MI040310076	73,01
101,4	115,4	MI040310102	96,95

Manguera CarbuCORD 16 bar

CarbuCORD hose 16 bar

Tuyau CarbuCORD 16 bar



Tubo CarbuCORD 16 bar

Ø OUTER Ø EXT.	Ø INNER Ø INT.	Part n° Referencia	€
42	30	M70003041	31,72
44	32	M70003243	33,46
55	40	M70004054	45,71
65	50	M70005064	49,35

Manguera SAE 100 R4

SAE 100 R4 hose

Tuyau SAE 100 R4



Tubo R4 SAE 100

DN	Part n° Referencia	€
3/4"	ML701019	*
1"	ML701025	*
1 1/4"	ML701032	*
1 1/2"	ML701038	*
2"	ML701050	*
2 1/2"	ML701063	*

*Ver precios en página 18 / *See prices page 18 / *Voir les prix page 18 / *Vedere prezzi p.18

Manguera EN 854 R6 / SAE 100 R6

EN 854 R6 / SAE 100 R6 Hose

Tuyau EN 854 R6 / SAE 100 R6



Tubo EN 854 R6 / SAE 100 R6

DN	Part n° Referencia	€
1/4"	MSB2104	*
5/16"	MSB2105	*
3/8"	MSB2106	*
1/2"	MSB2108	*
5/8"	MSB2110	*
3/4"	MSB2112	*
1"	MSB2116	*

*Ver precios en página 18 / *See prices page 18 / *Voir les prix page 18 / *Vedere prezzi p.18

Manguera industrial INDUS Δ le

Industrial hoses INDUS Δ le
Tuyaux industriels INDUS Δ le
Tubi industriali INDUS Δ le

INDUS Δ le[®]

Industrial hoses

Industrial fittings

Stainless steel hose, welding fittings and flanges

Low pressure

Air conditioning hoses and fittings

Soldadura acetileno

Welding hose acetylene

Tuyau pour soudure - acetilène



Tube saldatura-acetilene

Ø INNER Ø INT.	Ø outer Ø ext	Part n° Referencia	€
6,3	13,3	MI06030603	2,83
8	15	MI06030803	3,47
10	17	MI06031003	3,76

Bitubo (soldadura) oxígeno-acetileno

2 tubes welding hose - oxygene-acetylene

Tuyau pour soudure jumelé - oxygène-acétylène



Bitubo saldatura -ossigeno-acetilene

Ø INNER Ø INT.	Ø outer Ø ext	Part n° Referencia	€
6,3-6,3	12,3-12,3	MI0601060612	5,72
8-8	14-14	MI0601080814	6,30
10-10	16-16	MI0601101016	8,85

Soldadura oxígeno

Welding hose - oxygene

Tuyau pour soudure - oxygène



Tube saldatura-ossigeno

Ø INNER Ø INT.	Ø outer Ø ext	Part n° Referencia	€
6,3	13,3	MI06020603	2,83
8	15	MI06020803	3,47
10	17	MI06021003	3,76

Manguera industrial INDUSTrAle

Industrial hoses INDUSTrAle

Tuyaux industriels INDUSTrAle

Tubi industriali INDUSTrAle

INDUS TrAle®

Chorro de arena - impulsión 12 bar

Sandblast hose - delivery 12 bar

Tuyau sablage - refoulement 12 bar



Tubo scarico - sabbia 12 bar

Ø INNER Ø INT.	Ø outer Ø ext	Part n° Referencia	€
13	27	MI030112013	19,07
19	33	MI030112019	21,19
25	39	MI030112025	23,00
32	48	MI030112032	30,07
38	54	MI030112038	35,07
42	56	MI030112042	36,38

Abrasiva 10 bar aspiración

Abrasive hose - suction 10 bar

Tuyau abrasif - aspiration 10 bar



Tubo abrasivo - aspirazione 10 bar

Ø INNER Ø INT.	Ø outer Ø ext	Part n° Referencia	€
51	65	MI030210051	62,39
60	75	MI030210060	72,54
63.5	79	MI030210063	69,30
76	92	MI030210076	100,34
80	96	MI030210080	104,13
102	118	MI030210102	138,29

Productos químicos 16 bar EPDM

Chemical products hose 16 bar EPDM

Tuyau produits chimiques 16 bar EPDM



Tubo prodotti chimici 16 bar EPDM

Ø INNER Ø INT.	Ø outer Ø ext	Part n° Referencia	€
19	31	MI070116019	39,47
25	37	MI070116025	45,31
32	44	MI070116032	52,67
38	51	MI070116038	60,27
51	67	MI070116051	90,73
63	79	MI070116063	112,06

Abrasiva 4 bar impulsión

Abrasive hose - delivery 4 bar

Tuyau abrasif - refoulement 4 bar



Tubo abrasivo - scarico 4 bar

Ø INNER Ø INT.	Ø outer Ø ext	Part n° Referencia	€
90	100	MI030305090	73,56
102	112	MI030305102	81,61
110	120	MI030305110	86,95
127	137	MI030305127	103,59
152	162	MI030305152	119,44
203	213	MI030305203	*

Abrasiva impulsión 40 bar

Abrasive hose 40 bar

Tuyau abrasif 40 bar



Tubo abrasivo 40 bar

Ø INNER Ø INT.	Ø outer Ø ext	Part n° Referencia	€
25	37	MI030540025	28,14
32	46	MI030540032	35,31
35	49	MI030540035	38,72
38	54	MI030540038	45,13
50	66	MI030540050	59,75
65	83	MI030540065	80,61
76	98	MI030540076	138,85
102	125	MI030540102	195,60

Productos químicos 16 bar Polietileno/UPE

Chemical products hose 16 bar Polyethylene /UPE

Tuyau produits chimiques 16 bar Polyéthylène / UPE



Prodotti chimici 16 bar Polietilene/UPE

Ø INNER Ø INT.	Ø outer Ø ext	Part n° Referencia	€
19	31	MI070216019	54,56
25	37	MI070216025	63,34
32	44	MI070216032	74,12
38	51	MI070216038	75,88
50	66	MI070216050	104,22
63	79	MI070216063	157,25
75	91	MI070216075	201,38
100	116	MI070216100	265,24

Manguera industrial INDUS^{Tr}Δle

Industrial hoses INDUS^{Tr}Δle
Tuyaux industriels INDUS^{Tr}Δle
Tubi industriali INDUS^{Tr}Δle

INDUS^{Tr}Δle[®]

Industrial hoses

Industrial fittings

Stainless steel hose, welding fittings and flanges

Low pressure

Air conditioning hoses and fittings

Manguera alimentaria polivalente FDA 10 bar

Multi-function food hose FDA 10 bar

Tuyau alimentaire polyvalent FDA 10 bar

Tubo alimentare polivalente FDA 10 bar



Ø INNER Ø INT.	Ø outer Ø ext	Part nº Referencia	€
25,4	38	MAS025	43,83
32	45	MAS032	50,61
38	52	MAS038	56,03
50,8	66	MAS051	71,29
63,5	78	MAS063	100,45
76,2	93	MAS076	116,12

Leche anti-extrusión espiral poliamida 10 bar

Milk hose anti-extrusion polyamide spiral 10 bar

Tuyau à lait anti-extrusion spirale polyamide 10 bar

Tubo latte anti-estrusione spirale poliammide 10 bar



Ø INNER Ø INT.	Ø outer Ø ext	Part nº Referencia	€
25	38	MI020510025	50,55
32	45	MI020510032	58,39
38	52	MI020510038	65,46
51	66	MI020510051	82,31
63	78	MI020510063	115,71
76	93	MI020510076	134,80

Bebidas alcohólicas máx. 40% FDA 10 bar

Alcoholic beverages max. 40% FDA 10 bar

Boissons alcoolisées max. 40% bar FDA 10

Bibite alcoliche max. 40% FDA 10 bar



Ø INNER Ø INT.	Ø outer Ø ext	Part nº Referencia	€
25	37	MI020610025	44,19
38	50	MI020610038	63,69
51	63	MI020610051	75,88
76	88	MI020610076	116,89



RACORES INOX PARA INDUSTRIA ALIMENTARIA FOOD INDUSTRY STAINLESS STEEL FITTINGS

SMS
Tri-Clamp ISO 2852
DIN 11851
Macon
PTFE STD Series



Consulta en nuestra ficha técnica. Ver precios en Catálogo Racores Inox | Check our technical sheet for data options. See prices in Stainless Steel Fittings Catalogue

Racores industriales

Industrial fittings

Raccords industriels

Raccordi industriali

CAMLOCK DIN 2828	138
<i>CAMLOCK DIN 2828 Fittings / Raccords CAMLOCK / Raccordi CAMLOCK</i>	
Acoples GUILLEMIN NF E-29572	144
<i>GUILLEMIN NF E-29572 Fittings / Raccords GUILLEMIN NF E-29572 / Raccordi GUILLEMIN NF E-29572</i>	
Acoples TW DIN 28450	146
<i>TW DIN 28450 Fittings / Raccords TW DIN 28450 / Raccordi TW DIN 28450</i>	
Acople BARCELONA UNE 23400	147
<i>BARCELONA UNE 23400 Fittings / Raccords BARCELONA UNE 23400 / Raccordi BARCELONA UNE 23400</i>	
Acoples STORZ DIN 1430	148
<i>STORZ DIN 1430 Fittings / Raccords STORZ DIN 1430 / Raccordi STORZ DIN 1430</i>	
Acoples EA DIN 3489	149
<i>EA DIN 3489 Fittings / Raccords EA DIN 3489 / Raccordi EA DIN 3489</i>	
Acoples UA CHICAGO	150
<i>UA CHICAGO Fittings / Raccords UA CHICAGO / Raccordi UA CHICAGO</i>	
Acoples EXPRESS NF E-29-573	151
<i>EXPRESS NF E-29-573 Fittings / Raccords EXPRESS NF E-29-573 / Raccordi EXPRESS NF E-29-573</i>	
Acoples GEKA	152
<i>GEKA Fittings / Raccords GEKA / Raccordi GEKA</i>	

2

INDUG TrAle[®]

Acoples CAMLOCK MORTERO	153
<i>MORTAR CAMLOCK Fittings / Raccords MORTIER CAMLOCK / Raccordi CAMLOCK MORTAIO</i>	
Acoples CHORRO DE ARENA	154
<i>SANDBLAST Fittings / Raccords SABLAGE / Raccordi per SABBIATURA</i>	
Acoples BAUER	156
<i>BAUER Fittings / Raccords BAUER / Raccordi BAUER</i>	
Acoples PERROT	157
<i>PERROT Fittings / Raccords PERROT / Raccordi PERROT</i>	
Acoples vapor tipo BOSS	158
<i>Steam fittings BOSS type / Raccords vapeur type BOSS / Raccordi per vapore tipo BOSS</i>	
Acoples vapor EN 14423	159
<i>Steam EN 14423 fittings / Raccords vapeur EN 14423 / Raccordi per vapore EN 14423</i>	
Accesorios industriales	160
<i>Industrial accessories / Accessoires industriels / Accessori industriale</i>	

CAMLOCK DIN 2828

CAMLOCK DIN 2828 Fittings

Raccords CAMLOCK

Raccordi CAMLOCK

■ CAMLOCK aluminio / CAMLOCK Unions aluminum / Raccords CAMLOCK aluminium / Raccordi CAMLOCK alluminio | 138



ALA



ALB



ALC



ALD



ALE



ALF



ALDC



ALDP

■ CAMLOCK latón / CAMLOCK Unions brass / Raccords CAMLOCK laiton / Raccordi CAMLOCK ottone | 140



BRA



BRB



BRD



BRE



BRC



BRDC



BRF



BRDP

■ CAMLOCK PP / CAMLOCK Unions PP / Raccords CAMLOCK PP / Raccordi CAMLOCK polipropilene | 142



PPA



PPB



PPC



PPD



PPE



PPF



PPDC



PPDP

■ Juntas CAMLOCK / CAMLOCK Seals / Joints CAMLOCK / Guarnizioni per Camlock | 143



JCAMNBR



JCAMS

Acoples GUILLEMIN NF E-29572

GUILLEMIN NF E-29572 Fittings
 Raccords GUILLEMIN NF E-29572
 Raccordi GUILLEMIN NF E-29572

- GUILLEMIN aluminio / GUILLEMIN aluminum / GUILLEMIN aluminium / GUILLEMIN alluminio | 144



ALGU01C



ALGU02C



ALGU01S



ALGU02S



ALGU04C



ALGU03C



ALGU04S



ALGU05C

- Juntas para GUILLEMIN / Seals for GUILLEMIN / Joints pour GUILLEMIN / Guarnizioni per GUILLEMIN | 145



NBRGU

Acoples TW DIN 28450

TW DIN 28450 Fittings
 Raccords TW DIN 28450
 Raccordi TW DIN 28450

- TW Latón / TW brass / TW laiton / TW Ottone | 146



BRMK



BRVK

- TW aluminio / TW aluminum / TW aluminium / TW alluminio | 146



ALMB/BRMB



ALVB/BRVB

Acople BARCELONA UNE 23400

BARCELONA UNE 23400 Fittings
 Raccords BARCELONA UNE 23400
 Raccordi BARCELONA UNE 23400

- BARCELONA Aluminio / BARCELONA aluminium / BARCELONA aluminium / BARCELONA Alluminio | 147



ALBA01

ALBA03

ALBA05

ALBA02

ALBA04

- Juntas BARCELONA / BARCELONA seals / Joints BARCELONA / Guarnizioni BARCELONA | 147



NBRBA

Acoples STORZ DIN 1430

STORZ DIN 1430 Fittings
 Raccords STORZ DIN 1430
 Raccordi STORZ DIN 1430

- STORZ aluminio DIN 1430 / STORZ aluminium DIN 1430 / STORZ aluminium DIN 1430 / STORZ alluminio DIN 1430 | 148



ALST01

ALST03

ALST05

ALST02

ALST04

- Juntas STORZ / STORZ Seals / STORZ Joints / Guarnizioni STORZ | 148



NBRST

Acoples EA DIN 3489

EA DIN 3489 Fittings
Raccords EA DIN 3489
Raccordi EA DIN 3489

- EA acero / EA steel / EA acier / EA acciaio

| 149



EA01



EA02



EA04



EA05

- Juntas EA / EA seals / Joints EA / Guarnizioni EA

| 149



NBREA

Acoples UA CHICAGO

UA CHICAGO Fittings
Raccords UA CHICAGO
Raccordi UA CHICAGO

- UA CHICAGO ACERO / UA CHICAGO steel / UA CHICAGO acier / UA CHICAGO acciaio

| 150



UA01



UA02



UA04



UA05

- JUNTAS UA CHICAGO / UA CHICAGO seals / Joints UA CHICAGO / Guarnizioni UA CHICAGO

| 150



NBRUA

Acoples EXPRESS NF E-29-573

EXPRESS NF E-29-573 Fittings
 Raccords EXPRESS NF E-29-573
 Raccordi EXPRESS NF E-29-573

- EXPRESS latón / EXPRESS brass / EXPRESS laiton / EXPRESS ottone | 151



BREX01



BREX02



BREX04



BREX05

- Juntas EXPRESS / EXPRESS seals / Joints EXPRESS / Guarnizioni EXPRESS | 151



NBREX

Acoples GEKA

GEKA Fittings
 Raccords GEKA
 Raccordi GEKA

- GEKA latón / GEKA brass / GEKA laiton / GEKA ottone | 152



BRGE01



BRGE02



BRGE04



BRGE05

- Juntas GEKA / GEKA seals / Joints GEKA / Guarnizioni GEKA | 152



NBRGE

Acoples CAMLOCK MORTERO

MORTAR CAMLOCK Fittings
 Raccords MORTIER CAMLOCK
 Raccordi CAMLOCK MORTAIO

- CAMLOCK MORTERO acero carbono / Carbon steel MORTAR CAMLOCK / CAMLOCK MORTIER acier carbone / CAMLOCK MORTAIO acciaio al carbonio | 153



MT22A



MT22C



MT22D



MT22E

Acoples CHORRO DE ARENA

SANDBLAST Fittings
Raccords SABLAGE
Raccordi per SABBIATURA

- CHORRO DE ARENA aluminio / SANDBLAST aluminum / SABLAGE aluminium / SABBIATURA alluminio | 154



ALCH05

ALCH01

ALCH07

- CHORRO DE ARENA latón / SANDBLAST brass / SABLAGE laiton / SABBIATURA ottone | 154



BRCH05

BRCH01

BRCH07

- CHORRO DE ARENA nylon / SANDBLAST nylon / SABLAGE nylon / SABBIATURA Nylon | 155



NYCH05

NYCH01

NYCH07

- Juntas CHORRO DE ARENA / SANDBLAST Seals / SABLAGE Joints / SABBIATURA Guarnizioni | 155



NBRCH

Acoples BAUER

BAUER Fittings
Raccords BAUER
Raccordi BAUER

- BAUER acero / BAUER carbon steel / BAUER acier / BAUER acciaio | 156



BE

BEM

BEF

- JUNTA BAUER / BAUER seals / Joints BAUER / Guarnizioni BAUER | 156



NBRBE

Acoples PERROT

PERROT Fittings
Raccords PERROT
Raccordi PERROT

- PERROT acero /PERROT carbon steel /PERROT acier /PERROT acciaio | 157



PE

PEM

PEF

- Juntas PERROT /PERROT seals / Joints PERROT /Guarnizioni PERROT | 157



NBRPE

Acoples vapor tipo BOSS

Steam fittings BOSS type
Raccords vapeur type BOSS
Raccordi per vapore tipo BOSS

- BOSS acero /BOSS carbon steel /BOSS acier /BOSS acciaio | 158



B01_3

Acoples vapor EN 14423

Steam EN 14423 fittings
Raccords vapeur EN 14423
Raccordi per vapore EN 14423

- EN 144423 acero carbono /EN 14423 steel fittings /Raccords EN 14423 acier /Raccordi EN 14423 acciaio | 159



AB06



STE01



STE02

Accesorios industriales

Industrial accessories
Accessoires industriels
Accessori industriali

- Campana para racor industrial / Crimping Ferrule for industrial fitting / Jupe pour raccord industriel / Boccia per raccordo industriale | 160



ALCA

- Abrazadera para racor industrial / Clamp for industrial fitting / Collier pour raccord industriel / Collare per raccordo industriale | 160



ALAB01



AB03



AB05



AB04



AB02

CAMLOCK DIN 2828

CAMLOCK DIN 2828 Fittings
Raccords CAMLOCK
Raccordi CAMLOCK

CAMLOCK aluminio macho - rosca hembra BSP Tipo A

CAMLOCK aluminum male - female threaded BSP A Type

CAMLOCK aluminium -adaptateur mâle - filetage femelle Type A

CAMLOCK alluminio -adattatore maschio-filettatura femmina Tipo A



DN	THREAD ROSCA	Part nº Referencia	€
12	1/2"	ALA012	2,43
20	3/4"	ALA020	2,63
25	1"	ALA025	3,42
32	1" 1/4	ALA032	4,54
40	1" 1/2	ALA040	5,26
50	2"	ALA050	6,12
65	2" 1/2	ALA065	10,86
80	3"	ALA080	10,40
100	4"	ALA100	18,95

CAMLOCK aluminio hembra - rosca macho BSPT Tipo B

CAMLOCK aluminum female - male threaded BSPT B Type

CAMLOCK aluminium -adaptateur femelle - filetage mâle Type B

CAMLOCK alluminio -adattatore femmina-filettatura maschio Tipo B



DN	THREAD ROSCA	Part nº Referencia	€
12	1/2"	ALB012	5,79
20	3/4"	ALB020	6,45
25	1"	ALB025	7,83
32	1" 1/4	ALB032	11,65
40	1" 1/2	ALB040	12,11
50	2"	ALB050	13,95
65	2" 1/2	ALB065	16,58
80	3"	ALB080	22,37
100	4"	ALB100	31,32

CAMLOCK aluminio hembra - para manguera Tipo C

CAMLOCK aluminum female - serrated hose shank C Type

CAMLOCK aluminium -coupleur femelle Type C

CAMLOCK alluminio -adattatore con inserto per tubo Tipo C



DN	THREAD ROSCA	Part nº Referencia	€
1/2"	12	ALC012	5,79
3/4"	20	ALC020	6,45
1"	25	ALC025	8,09
1"1/4	32	ALC032	12,24
1"1/2	40	ALC040	13,16
2"	50	ALC050	16,38
2"1/2	65	ALC065	19,21
3"	80	ALC080	26,78
4"	100	ALC100	35,79

CAMLOCK aluminio hembra - rosca hembra BSP Tipo D

CAMLOCK aluminum female - female threaded BSP D Type

CAMLOCK aluminium -adaptateur femelle Type D

CAMLOCK alluminio -adattatore femmina Tipo D



DN	THREAD ROSCA	Part nº Referencia	€
12	1/2"	ALD012	5,46
20	3/4"	ALD020	6,51
25	1"	ALD025	8,09
32	1" 1/4	ALD032	12,04
40	1" 1/2	ALD040	12,83
50	2"	ALD050	14,94
65	2" 1/2	ALD065	18,29
80	3"	ALD080	23,29
100	4"	ALD100	34,08

CAMLOCK aluminio macho - para manguera Tipo E

CAMLOCK aluminum male - serrated hose shank E Type

CAMLOCK aluminium -coupleur mâle Type E

CAMLOCK alluminio -adattatore con inserto per tubo Tipo E



DN	THREAD ROSCA	Part nº Referencia	€
1/2"	12	ALE012	2,57
3/4"	20	ALE020	2,83
1"	25	ALE025	3,88
1"1/4	32	ALE032	5,59
1"1/2	40	ALE040	6,65
2"	50	ALE050	8,95
2"1/2	65	ALE065	15,86
3"	80	ALE080	18,03
4"	100	ALE100	27,77

CAMLOCK aluminio macho - rosca macho BSPT Tipo F

CAMLOCK aluminum male - male threaded BSPT F Type

CAMLOCK aluminium -adaptateur mâle Type F

CAMLOCK alluminio -adattatore maschio Tipo F



DN	THREAD ROSCA	Part nº Referencia	€
12	1/2"	ALF012	2,83
20	3/4"	ALF020	2,83
25	1"	ALF025	4,15
32	1" 1/4	ALF032	6,12
40	1" 1/2	ALF040	7,17
50	2"	ALF050	9,08
65	2" 1/2	ALF065	14,87
80	3"	ALF080	16,45
100	4"	ALF100	27,44

CAMLOCK DIN 2828

CAMLOCK DIN 2828 Fittings
Raccords CAMLOCK
Raccordi CAMLOCK

CAMLOCK aluminio hembra - tapón Tipo DC

CAMLOCK aluminum cap DC Type

CAMLOCK aluminium -bouchon femelle Type DC

CAMLOCK alluminio -tappo di protezione Tipo DC



DN	Part nº Referencia	€
12	ALDC012	5,40
20	ALDC020	6,12
25	ALDC025	7,37
32	ALDC032	10,72
40	ALDC040	11,45
50	ALDC050	13,36
65	ALDC065	15,26
80	ALDC080	20,27
100	ALDC100	29,15

CAMLOCK aluminio macho - tapón tipo DP

CAMLOCK aluminum male - plug DC Type

CAMLOCK aluminium -bouchon mâle Type DP

CAMLOCK alluminio -cappuccio di protezione
Tipo DP



DN	Part nº Referencia	€
12	ALDP012	1,58
20	ALDP020	2,24
25	ALDP025	2,83
32	ALDP032	4,21
40	ALDP040	4,74
50	ALDP050	6,84
65	ALDP065	9,47
80	ALDP080	10,79
100	ALDP100	18,23

CAMLOCK DIN 2828

CAMLOCK DIN 2828 Fittings
Raccords CAMLOCK
Raccordi CAMLOCK

CAMLOCK latón macho - rosca hembra Tipo A

CAMLOCK brass - adaptor, female threaded A Type

CAMLOCK laiton - adaptateur mâle - filetage femelle Type A

CAMLOCK ottone - adattatore maschio-filettatura femmina Tipo A



DN	THREAD ROSCA	Part nº Referencia	€
12	1/2"	BRA012	6,85
20	3/4"	BRA020	7,75
25	1"	BRA025	9,37
32	1" 1/4	BRA032	13,43
40	1" 1/2	BRA040	19,42
50	2"	BRA050	24,41
65	2" 1/2	BRA065	34,63
80	3"	BRA080	41,76
100	4"	BRA100	76,15

CAMLOCK latón hembra - rosca macho Tipo B

CAMLOCK brass - coupling, female threaded B Type

CAMLOCK laiton - adaptateur femelle - filetage mâle Type B

CAMLOCK ottone - adattatore femmina-filettatura maschio Tipo B



DN	THREAD ROSCA	Part nº Referencia	€
12	1/2"	BRB012	15,59
20	3/4"	BRB020	13,27
25	1"	BRB025	18,53
32	1" 1/4	BRB032	27,83
40	1" 1/2	BRB040	32,41
50	2"	BRB050	38,70
65	2" 1/2	BRB065	49,57
80	3"	BRB080	69,06
100	4"	BRB100	96,41

CAMLOCK latón hembra para manguera Tipo C

CAMLOCK brass - coupling with serrated hose shank C Type

CAMLOCK laiton - coupleur femelle Type C

CAMLOCK ottone - adattatore con inserto per tubo Tipo C



DN	THREAD ROSCA	Part nº Referencia	€
1/2"	12	BRC012	16,88
3/4"	20	BRC020	16,73
1"	25	BRC025	23,11
1"1/4	32	BRC032	34,77
1"1/2	40	BRC040	42,76
2"	50	BRC050	52,35
2"1/2	65	BRC065	71,95
3"	80	BRC080	96,87
4"	100	BRC100	158,97

CAMLOCK latón hembra BSP Tipo D

CAMLOCK brass - coupling, female threaded D Type

CAMLOCK laiton - adaptateur femelle Type D

CAMLOCK ottone - adattatore femmina Tipo D



DN	THREAD ROSCA	Part nº Referencia	€
12	1/2"	BRD012	15,52
20	3/4"	BRD020	16,55
25	1"	BRD025	20,51
32	1" 1/4	BRD032	31,11
40	1" 1/2	BRD040	33,71
50	2"	BRD050	42,67
65	2" 1/2	BRD065	49,57
80	3"	BRD080	76,79
100	4"	BRD100	115,76

CAMLOCK latón macho para manguera Tipo E

CAMLOCK brass - adaptor, with serrated hose shank E Type

CAMLOCK laiton - coupleur mâle Type E

CAMLOCK ottone - adattatore con inserto per Tipo E



DN	THREAD ROSCA	Part nº Referencia	€
1/2"	12	BRE012	9,85
3/4"	20	BRE020	11,36
1"	25	BRE025	17,43
1"1/4	32	BRE032	23,41
1"1/2	40	BRE040	32,78
2"	50	BRE050	41,76
2"1/2	65	BRE065	66,78
3"	80	BRE080	96,87
4"	100	BRE100	160,28

CAMLOCK latón macho BSPT Tipo F

CAMLOCK brass - adaptor, male threaded F Type

CAMLOCK laiton - adaptateur mâle Type F

CAMLOCK ottone - adattatore maschio Tipo F



DN	THREAD ROSCA	Part nº Referencia	€
12	1/2"	BRF012	8,37
20	3/4"	BRF020	9,37
25	1"	BRF025	12,05
32	1" 1/4	BRF032	19,04
40	1" 1/2	BRF040	23,11
50	2"	BRF050	32,39
65	2" 1/2	BRF065	48,05
80	3"	BRF080	65,80
100	4"	BRF100	101,63

CAMLOCK DIN 2828

CAMLOCK DIN 2828 Fittings
Raccords CAMLOCK
Raccordi CAMLOCK

CAMLOCK latón hembra -tapón Tipo DC

CAMLOCK brass - cap DC Type

CAMLOCK laiton -bouchon femelle Type DC

CAMLOCK ottone -tappo di protezione Tipo DC



DN		Part nº Referencia	€
1/2"	12	BRDC012	12,98
3/4"	20	BRDC020	14,74
1"	25	BRDC025	18,73
1"1/4	32	BRDC032	29,40
1"1/2	40	BRDC040	32,78
2"	50	BRDC050	41,45
2"1/2	65	BRDC065	52,86
3"	80	BRDC080	62,79
4"	100	BRDC100	90,19

CAMLOCK latón macho -tapón Tipo DP

CAMLOCK brass - plug DP Type

CAMLOCK laiton -bouchon mâle Type DP

CAMLOCK ottone -cappuccio di protezione Tipo DP



DN		Part nº Referencia	€
1/2"	12	BRDP012	5,56
3/4"	20	BRDP020	5,76
1"	25	BRDP025	8,75
1"1/4	32	BRDP032	13,36
1"1/2	40	BRDP040	16,73
2"	50	BRDP050	26,71
2"1/2	65	BRDP065	36,54
3"	80	BRDP080	55,34
4"	100	BRDP100	75,99

CAMLOCK DIN 2828

CAMLOCK DIN 2828 Fittings
Raccords CAMLOCK
Raccordi CAMLOCK

CAMLOCK PP Adaptador macho - rosca hembra Tipo A BSP

CAMLOCK PP-Adaptor, female threaded A Type BSP

CAMLOCK PP-Adaptateur mâle - filetage femelle Type A BSP

CAMLOCK PP-Adattatore maschio-filettatura femmina Tipo A BSP



DN	THREAD ROSCA	Part nº Referencia	€
12	1/2"	PPA012	0,92
20	3/4"	PPA020	0,97
25	1"	PPA025	1,08
32	1"1/4"	PPA032	1,60
40	1"1/2"	PPA040	1,86
50	2"	PPA050	2,99
65	2"1/2"	PPA065	3,79
80	3"	PPA080	4,72
100	4"	PPA100	11,75

CAMLOCK PP Adaptador hembra - rosca macho Tipo B BSPT

CAMLOCK PP-Coupling, female threaded B Type BSPT

CAMLOCK PP-Adaptateur femelle - filetage mâle Type B BSPT

CAMLOCK PP-Adattatore femmina-filettatura maschio Tipo B BSPT



DN	THREAD ROSCA	Part nº Referencia	€
12	1/2"	PPB012	4,95
20	3/4"	PPB020	5,12
25	1"	PPB025	6,17
32	1"1/4"	PPB032	9,24
40	1"1/2"	PPB040	9,53
50	2"	PPB050	10,19
65	2"1/2"	PPB065	12,13
80	3"	PPB080	14,79
100	4"	PPB100	29,33

CAMLOCK PP Conexión hembra para manguera Tipo C

CAMLOCK PP-Coupling with serrated hose shank C Type

CAMLOCK PP-Coupleur femelle Type C

CAMLOCK PP-Adattatore con inserto per tubo Tipo C



DN	THREAD ROSCA	Part nº Referencia	€
12	1/2"	PPC012	5,07
20	3/4"	PPC020	5,24
25	1"	PPC025	6,13
32	1"1/4"	PPC032	9,36
40	1"1/2"	PPC040	9,58
50	2"	PPC050	10,82
65	2"1/2"	PPC065	13,36
80	3"	PPC080	16,16
100	4"	PPC100	31,80

CAMLOCK PP Adaptador hembra Tipo D BSP

CAMLOCK PP-Coupling, female threaded D Type BSP

CAMLOCK PP-Adaptateur femelle Type D BSP

CAMLOCK PP-Adattatore femmina Tipo D BSP



DN	THREAD ROSCA	Part nº Referencia	€
12	1/2"	PPD012	4,86
20	3/4"	PPD020	4,80
25	1"	PPD025	5,75
32	1"1/4"	PPD032	9,10
40	1"1/2"	PPD040	9,64
50	2"	PPD050	10,31
65	2"1/2"	PPD065	10,87
80	3"	PPD080	14,19
100	4"	PPD100	30,85

CAMLOCK PP Conexión macho para manguera Tipo E

CAMLOCK PP-Adaptor, with serrated hose shank E Type

CAMLOCK PP-Coupleur mâle Type E

CAMLOCK PP-Adattatore con inserto per Tipo E



DN	THREAD ROSCA	Part nº Referencia	€
12	1/2"	PPE012	0,90
20	3/4"	PPE020	1,08
25	1"	PPE025	1,20
32	1"1/4"	PPE032	1,70
40	1"1/2"	PPE040	3,10
50	2"	PPE050	3,71
65	2"1/2"	PPE065	4,64
80	3"	PPE080	6,44
100	4"	PPE100	14,15

CAMLOCK PP Adaptador macho Tipo F BSPT

CAMLOCK PP-Adaptor, male threaded F Type BSPT

CAMLOCK PP-Adaptateur mâle Type F BSPT

CAMLOCK PP-Adattatore maschio Tipo F BSPT



DN	THREAD ROSCA	Part nº Referencia	€
12	1/2"	PPF012	0,97
20	3/4"	PPF020	1,15
25	1"	PPF025	1,18
32	1"1/4"	PPF032	1,74
40	1"1/2"	PPF040	1,93
50	2"	PPF050	3,31
65	2"1/2"	PPF065	4,37
80	3"	PPF080	5,09
100	4"	PPF100	13,49

CAMLOCK DIN 2828

CAMLOCK DIN 2828 Fittings
Raccords CAMLOCK
Raccordi CAMLOCK

CAMLOCK PP Tapón hembra Tipo DC

CAMLOCK PP-Caps DC Type

CAMLOCK PP-Bouchon femelle Type DC

CAMLOCK PP-Tappo di protezione Tipo DC



DN	THREAD ROSCA	Part nº Referencia	€
12	1/2"	PPDC012	3,54
20	3/4"	PPDC020	4,45
25	1"	PPDC025	5,64
32	1"1/4"	PPDC032	8,69
40	1"1/2"	PPDC040	9,49
50	2"	PPDC050	9,83
65	2"1/2"	PPDC065	12,28
80	3"	PPDC080	13,90
100	4"	PPDC100	28,20

CAMLOCK PP Tapón macho tipo DP

CAMLOCK PP-Plug DP Type

CAMLOCK PP-Bouchon mâle Type DP

CAMLOCK PP-Cappuccio di protezione Tipo DP



DN	THREAD ROSCA	Part nº Referencia	€
12	1/2"	PPDP012	0,96
20	3/4"	PPDP020	0,96
25	1"	PPDP025	1,12
32	1"1/4"	PPDP032	1,66
40	1"1/2"	PPDP040	1,88
50	2"	PPDP050	2,19
65	2"1/2"	PPDP065	3,58
80	3"	PPDP080	4,83
100	4"	PPDP100	10,25

Juntas CAMLOCK NBR

CAMLOCK NBR Seal

Joint CAMLOCK NBR

Guarnizione in NBR per CAMLOCK



DN	Part nº Referencia	€
12	JCAMNBR012	*
20	JCAMNBR020	*
25	JCAMNBR025	*
32	JCAMNBR032	*
40	JCAMNBR040	*
50	JCAMNBR050	*
65	JCAMNBR065	*
80	JCAMNBR080	*
100	JCAMNBR100	*

*Ver precios en Tarifa Inox pág. 198 / *See prices in Stainless steel Catalogue p. 198 / *Voir prix dans le Catalogue Acier Inox p. 198 / *Prezzi in Acciaio Inossidabile p. 198

Junta CAMLOCK silicona

CAMLOCK Silicone Seal

Joint CAMLOCK silicone

Guarnizione in silicone per CAMLOCK



DN	Part nº Referencia	€
12	JCAMS012	*
20	JCAMS020	*
25	JCAMS025	*
32	JCAMS032	*
40	JCAMS040	*
50	JCAMS050	*
65	JCAMS065	*
80	JCAMS080	*
100	JCAMS100	*

*Ver precios en Tarifa Inox pág. 198 / *See prices in Stainless steel Catalogue p. 198 / *Voir prix dans le Catalogue Acier Inox p. 198 / *Prezzi in Acciaio Inossidabile p. 198

CAMLOCK ACERO INOXIDABLE | STAINLESS STEEL



EN 14420-7 | DIN 2828

Ver ficha técnica | Check technical sheet

Para una amplia gama de aplicaciones como agua, petróleo y productos químicos
For a wide range of applications such as water, petroleum and chemical liquids

Acoples GUILLEMIN NF E-29572

GUILLEMIN NF E-29572 Fittings
Raccords GUILLEMIN NF E-29572
Raccordi GUILLEMIN NF E-29572

GUILLEMIN aluminio con cierre -rosca hembra BSP

GUILLEMIN aluminium with closure-BSP Female thread

GUILLEMIN aluminium avec fermeture-Filetage Femelle BSP

GUILLEMIN alluminio con chiusura-Filetto femmina



DN	THREAD ROSCA	Part n° Referencia	€
20	3/4"	ALGU01C020	8,55
25	1"	ALGU01C025	11,81
32	1" 1/4	ALGU01C032	13,83
40	1" 1/2	ALGU01C040	17,29
50	2"	ALGU01C050	25,50
65	2" 1/2	ALGU01C065	31,90
80	3"	ALGU01C080	35,72
100	4"	ALGU01C100	61,47

GUILLEMIN aluminio con cierre -rosca macho BSP

GUILLEMIN aluminium with closure-BSP Male thread

GUILLEMIN aluminium avec fermeture-Filetage Male BSP

GUILLEMIN alluminio con chiusura-Filetto maschio



DN	THREAD ROSCA	Part n° Referencia	€
20	3/4"	ALGU02C020	8,94
25	1"	ALGU02C025	8,94
32	1" 1/4	ALGU02C032	14,48
40	1" 1/2	ALGU02C040	11,35
50	2"	ALGU02C050	18,47
65	2" 1/2	ALGU02C065	20,48
80	3"	ALGU02C080	34,47
100	4"	ALGU02C100	37,18

GUILLEMIN aluminio sin cierre -rosca hembra BSP

GUILLEMIN aluminium without closure-BSP Female thread

GUILLEMIN aluminium sans fermeture-Filetage Femelle BSP

GUILLEMIN alluminio senza chiusura-Filetto femmina



DN	THREAD ROSCA	Part n° Referencia	€
20	3/4"	ALGU01S020	8,15
25	1"	ALGU01S025	8,15
32	1" 1/4	ALGU01S032	8,87
40	1" 1/2	ALGU01S040	6,86
50	2"	ALGU01S050	9,58
65	2" 1/2	ALGU01S065	11,14
80	3"	ALGU01S080	16,68
100	4"	ALGU01S100	20,23

GUILLEMIN aluminio sin cierre -rosca macho BSP

GUILLEMIN aluminium without closure-BSP Male thread

GUILLEMIN aluminium sans fermeture-Filetage Male BSP

GUILLEMIN alluminio senza chiusura-Filetto maschio



DN	THREAD ROSCA	Part n° Referencia	€
20	3/4"	ALGU02S020	8,15
25	1"	ALGU02S025	8,15
32	1" 1/4	ALGU02S032	9,46
40	1" 1/2	ALGU02S040	8,81
50	2"	ALGU02S050	11,61
65	2" 1/2	ALGU02S065	15,52
80	3"	ALGU02S080	22,44
100	4"	ALGU02S100	29,09

GUILLEMIN aluminio con cierre -tapón

GUILLEMIN aluminium with closure-Plug

GUILLEMIN aluminium avec fermeture-Bouchon

GUILLEMIN alluminio con chiusura-Tappo



DN	Part n° Referencia	€
20	ALGU04C020	10,50
25	ALGU04C025	10,50
32	ALGU04C032	10,50
40	ALGU04C040	12,20
50	ALGU04C050	16,11
65	ALGU04C065	19,24
80	ALGU04C080	27,14
100	ALGU04C100	34,05

GUILLEMIN aluminio con cierre-reductor

GUILLEMIN aluminium with closure-Reducer

GUILLEMIN aluminium avec fermeture-Réduction

GUILLEMIN alluminio con chiusura-Riduzione



DN	Part n° Referencia	€
40-32	ALGU03C040032	45,79
50-40	ALGU03C050040	40,32
65-50	ALGU03C065050	43,44
80-65	ALGU03C080065	59,88
100-80	ALGU03C100080	88,52

GUILLEMIN aluminio sin cierre -tapón

GUILLEMIN aluminium without closure-Plug

GUILLEMIN aluminium sans fermeture-Bouchon

GUILLEMIN alluminio senza chiusura-Tappo



DN	Part n° Referencia	€
32	ALGU04S032	12,00
40	ALGU04S040	12,00
50	ALGU04S050	11,09
65	ALGU04S065	17,03
80	ALGU04S080	17,68
100	ALGU04S100	23,94

Acoples GUILLEMIN NF E-29572

GUILLEMIN NF E-29572 Fittings
Raccords GUILLEMIN NF E-29572
Raccordi GUILLEMIN NF E-29572

GUILLEMIN aluminio con cierre -para manguera

GUILLEMIN aluminium with closure-For hose

GUILLEMIN aluminium avec fermeture-Pour tuyau

GUILLEMIN alluminio con chiusura-Per tubo



L (mm)	SIZE TAMAÑO	Part nº Referencia	€
37	40	ALGU05C040040	15,22
37	40	ALGU05C040045	15,22
50	50	ALGU05C050050	21,36
50	50	ALGU05C050055	18,79
50	65	ALGU05C065065	27,07
70	80	ALGU05C080080	34,57
97	100	ALGU05C100100	52,18

GUILLEMIN -junta NBR

GUILLEMIN -NBR joint

GUILLEMIN -joint NBR

GUILLEMIN -Guarnizioni NBR



DN	SIZE TAMAÑO	Part nº Referencia	€
20	3/4"	NBRGU020	0,39
25	1"	NBRGU025	0,65
32	1"1/4	NBRGU032	0,72
40	1"1/2	NBRGU040	1,24
50	2"	NBRGU050	1,30
65	2"1/2	NBRGU065	2,35
80	3"	NBRGU080	2,67
100	4"	NBRGU100	5,41

GUILLEMIN ACERO INOXIDABLE | STAINLESS STEEL



EN 14420-8 | NF E-29572

Ver ficha técnica | Check technical sheet

Aplicaciones de presión y aspiración en un amplio rango de industrias

Pressure and suction purposes in a wide range of industries

Acoples TW DIN 28450

TW DIN 28450 Fittings
Raccords TW DIN 28450
Raccordi TW DIN 28450

TW latón -Rosca hembra - acople hembra BSP

TW brass -Female thread - female coupling

TW laiton -Filetage Femelle - accouplement Femelle BSP

TW ottone -Filetto femmina- accoppiamento femmina BSP



DN	Part nº Referencia	€
2"	BRMK05032	58,64
3"	BRMK08048	110,89
4"	BRMK10064	221,25

TW latón -Rosca hembra - acople macho BSP

TW brass -Female thread - male coupling

TW laiton - Filetage Femelle - accouplement Male BSP

TW ottone -Filetto femmina- accoppiamento maschio BSP



DN	Ø	Part nº Referencia	€
2"	70.5	BRVK05032	23,61
3"	102	BRVK08048	55,51
4"	128	BRVK10064	83,36

TW aluminio-Tapón - acople hembra

TW aluminum -Female Dust Cap coupling

TW aluminium -Bouchon - accouplement Femelle

TW alluminio -Tappo- accoppiamento femmina



DN	Part nº Referencia	€	Part Nº STA Referencia STA	€
2"	ALMB050	11,35	BRMB050	18,98
3"	ALMB080	22,77	BRMB080	54,01
4"	ALMB100	47,75	BRMB100	92,82

TW aluminio-Tapón - acople macho

TW aluminum - Male Dust Plug coupling

TW aluminium -Bouchon - accouplement Mâle

TW alluminio -Tappo- accoppiamento maschio



DN	Ø	Part nº Referencia	€	Part Nº STA Referencia STA	€
2"	70.5	ALVB050	8,35	BRVB050	18,72
3"	102	ALVB080	16,05	BRVB080	48,92
4"	128	ALVB100	32,35	BRVB100	71,75

Acople BARCELONA UNE 23400

BARCELONA UNE 23400 Fittings
Raccords BARCELONA UNE 23400
Raccordi BARCELONA UNE 23400

BARCELONA aluminio -Rosca hembra BSP

BARCELONA aluminium- Female thread BSP

BARCELONA aluminium- Filetage femelle BSP

BARCELONA Alluminio- Filetto femmina BSP



THREAD ROSCA	SIZE TAMAÑO	Part nº Referencia	€
1"	DN 25	ALBA0102516	11,39
1" 1/2	DN 45	ALBA0104524	17,83
2" 1/2	DN 70	ALBA0107040	34,57

BARCELONA aluminio -Reductor

BARCELONA aluminium- Reducer

BARCELONA aluminium- Reducteur

BARCELONA Alluminio- Riduttore



SIZE TAMAÑO	Part nº Referencia	€
70-45	ALBA03070045	72,34
45-25	ALBA03045025	37,57

BARCELONA aluminio -Para manguera

BARCELONA aluminium- For hose

BARCELONA aluminium- Pour tuyau

BARCELONA Alluminio- Per tubo



DN	Part nº Referencia	€
25	ALBA05025025	18,03
45	ALBA05045045	29,69
70	ALBA05070070	50,97

Juntas NBR BARCELONA

NBR BARCELONA seals

Joints NBR BARCELONA

Guarnizioni NBR BARCELONA



DN	Part nº Referencia	€
25	NBRBA025	0,61
45	NBRBA045	0,91
70	NBRBA070	1,52

BARCELONA aluminio -Rosca macho BSP

BARCELONA aluminium- Male thread BSP

BARCELONA aluminium- Filetage mâle BSP

BARCELONA Alluminio- Filetto maschio BSP



THREAD ROSCA	SIZE TAMAÑO	Part nº Referencia	€
1"	25	ALBA0202516	10,85
1" 1/2	45	ALBA0204524	19,86
2" 1/2	70	ALBA0207040	41,08

BARCELONA aluminio -Tapón

BARCELONA aluminium- Dust Cap

BARCELONA aluminium- Bouchon

BARCELONA Alluminio- Tappo



SIZE TAMAÑO	Part nº Referencia	€
25	ALBA04025	10,76
45	ALBA04045	13,44
70	ALBA04070	25,63

Acoples STORZ DIN 1430

STORZ DIN 1430 Fittings
Raccords STORZ DIN 1430
Raccordi STORZ DIN 1430

STORZ aluminio- Rosca hembra BSP

STORZ aluminium- Female thread BSP

STORZ aluminium- Filetage femelle BSP

STORZ Alluminio- Filetto femmina BSP



DN	THREAD ROSCA	Part nº Referencia	€
25	1"	ALST01025D16	18,00
38	1"1/2	ALST0103824	18,59
52	2"	ALST01052C32	16,63
65	2"1/2	ALST0106540	36,40
75	3"	ALST01075B48	32,57
110	4"	ALST01110A64	74,11

STORZ aluminio- Reductor

STORZ aluminium- Reducer

STORZ aluminium- Reducteur

STORZ Alluminio- Riduttore



DN	Part nº Referencia	€
25-52	ALST03052C025D	48,99
52-75	ALST03075B052C	64,25
65-110	ALST03110A065	150,61
75-110	ALST03110A075B	129,54

STORZ aluminio- Para manguera

STORZ aluminium- For hose

STORZ aluminium- Pour tuyau

STORZ Alluminio- Per tubo



DN	Part nº Referencia	€
25	ALST05025D	13,05
38	ALST05038038	21,40
52	ALST05052C052	19,83
65	ALST05065065	37,18
75	ALST05075B075	36,15
100	ALST05110A100	75,95

Juntas NBR STORZ

STORZ - NBR Seals

Joints STORZ - NBR

STORZ - Guarnizioni NBR



DN	Part nº Referencia	€
25	NBRST025D	0,38
38	NBRST038	0,53
52	NBRST052C	0,69
65	NBRST065	1,14
75	NBRST075B	1,52
100	NBRST110A	4,19

STORZ aluminio- Rosca macho BSP

STORZ aluminium- Male thread BSP

STORZ aluminium- Filetage mâle BSP

STORZ Alluminio- Filetto maschio BSP



DN	THREAD ROSCA	Part nº Referencia	€
25	1"	ALST02025D16	20,74
	1"1/2	ALST0203820	27,01
52	2"	ALST02052C32	18,39
65	2"1/2	ALST0206540	36,40
75	3"	ALST02075B48	36,14
110	4"	ALST02110A64	73,77

STORZ aluminio- Tapón

STORZ aluminium- Cap

STORZ aluminium- Bouchon

STORZ Alluminio- Tappo



DN	Part nº Referencia	€
25	ALST04025D	18,59
38	ALST04038	28,44
52	ALST04052C	20,87
65	ALST04065	35,68
75	ALST04075B	33,20
100	ALST04110A	72,60

Acoples EA DIN 3489

EA DIN 3489 Fittings
Raccords EA DIN 3489
Raccordi EA DIN 3489

Industrial hoses

Industrial fittings

Stainless steel hose, welding fittings and flanges

Low pressure

Air conditioning hoses and fittings

EA acero- Rosca hembra BSP

EA steel- Female thread BSP

EA acier- Filetage femelle BSP

EA acciaio - Filetto femmina BSP



THREAD ROSCA	Part n° Referencia	€
1/2"	EA0108	3,85
3/4"	EA0112	4,31
1"	EA0116	4,63

EA acero- Rosca macho BSP

EA steel- Male thread BSP

EA acier- Filetage mâle BSP

EA acciaio - Filetto maschio BSP



THREAD ROSCA	Part n° Referencia	€
1/2"	EA0208	4,50
3/4"	EA0212	4,63
1"	EA0216	5,48

Juntas NBR EA

EA NBR seals

Joints NBR EA

Guarnizioni EA NBR



DN	Part n° Referencia	€
for all sizes	NBREA	0,42

EA acero- Tapón

EA steel- Cap

EA acier- Bouchon

EA acciaio - Tappo



DESCRIPTION DESCRIPCIÓN	Part n° Referencia	€
Tapón	EA04	4,44

EA acero- Para manguera c/collar

EA steel- For hose

EA acier- Pour tuyau avec collier

EA acciaio - Per tubo



DN	Part n° Referencia	€
13	EA0513	4,63
16	EA0516	4,89
19	EA0519	4,89
25	EA0525	5,74

Acoples UA CHICAGO

UA CHICAGO Fittings
Raccords UA CHICAGO
Raccordi UA CHICAGO

UA CHICAGO acero- Rosca hembra NPT

UA CHICAGO steel- Female thread NPT

UA CHICAGO acier- Filetage femelle NPT

UA CHICAGO acciaio - Filetto femmina NPT



THREAD ROSCA	Part n° Referencia	€
1/4" NPT	UA0104	4,50
3/8" NPT	UA0106	4,50
1/2" NPT	UA0108	4,70
3/4" NPT	UA0112	4,96
1" NPT	UA0116	5,94
1" 1/4 NPT	UA0120	18,26
1" 1/2 NPT	UA0124	19,31
2" NPT	UA0132	19,77

UA CHICAGO acero- Rosca macho NPT

UA CHICAGO steel- Male thread NPT

UA CHICAGO acier- Filetage mâle NPT

UA CHICAGO acciaio - Filetto maschio NPT



THREAD ROSCA	Part n° Referencia	€
1/4" NPT	UA0204	4,63
3/8" NPT	UA0206	4,63
1/2" NPT	UA0208	4,83
3/4" NPT	UA0212	5,28
1" NPT	UA0216	6,33
1 1/4" NPT	UA0220	24,00
1 1/2" NPT	UA0224	25,57
2" NPT	UA0232	26,68

NBR JUNTAS UA CHICAGO

UA CHICAGO NBR seals

Joints NBR UA CHICAGO

Guarnizioni UA CHICAGO NBR



DN	Part n° Referencia	€
for all sizes	NBRUA02	0,46

UA CHICAGO acero- Tapón

UA CHICAGO steel- Cap

UA CHICAGO acier- Bouchon

UA CHICAGO acciaio - Tappo



Part n° Referencia	€
UA0402	5,68

UA CHICAGO acero- Para manguera c/collar

UA CHICAGO steel- For hose

UA CHICAGO acier- Pour tuyau avec collier

UA CHICAGO acciaio - Per tubo



DN	Part n° Referencia	€
7	UA0507	5,87
10	UA0510	4,83
13	UA0513	5,22
19	UA0519	5,35
25	UA0525	6,13
32	UA0532	18,98
38	UA0538	20,29
50	UA0550	25,63

Acoples EXPRESS NF E-29-573

EXPRESS NF E-29-573 Fittings
Raccords EXPRESS NF E-29-573
Raccordi EXPRESS NF E-29-573

Industrial hoses

Industrial fittings

Stainless steel hose, welding fittings and flanges

Low pressure

Air conditioning hoses and fittings

EXPRESS latón- Rosca hembra BSP

EXPRESS brass- Female thread BSP

EXPRESS laiton- Filetage femelle BSP

EXPRESS ottone - Filetto femmina BSP



THREAD ROSCA	Part n° Referencia	€
1/4"	BREX0104	5,48
3/8"	BREX0106	5,48
1/2"	BREX0108	5,74
3/4"	BREX0112	6,26
1"	BREX0116	6,26
1" 1/4	BREX0120	9,00

EXPRESS latón- Rosca macho BSP

EXPRESS brass- Male thread BSP

EXPRESS laiton- Filetage mâle BSP

EXPRESS ottone - Filetto maschio BSP



THREAD ROSCA	Part n° Referencia	€
1/4"	BREX0204	5,48
3/8"	BREX0206	6,07
1/2"	BREX0208	5,55
3/4"	BREX0212	5,87
1"	BREX0216	6,72
1" 1/4	BREX0220	10,37

Juntas NBR EXPRESS

NBR EXPRESS seals

Joints NBR EXPRESS

Guarnizioni EXPRESS



DN	Part n° Referencia	€
for all sizes	NBEX	0,42

EXPRESS latón- Tapón

EXPRESS brass- Cap

EXPRESS laiton- Bouchon

EXPRESS ottone - Tappo



DESCRIPTION DESCRIPCIÓN	Part n° Referencia	€
Tapón	BREX04	5,61

EXPRESS latón- Para manguera

EXPRESS brass- For hose

EXPRESS laiton- Pour tuyau

EXPRESS ottone - Per tubo



Ø OUTER Ø EXT.	SIZE TAMAÑO	Part n° Referencia	€
9	7-9	BREX0508	5,61
10	8-10	BREX0510	4,96
12	11-13	BREX0513	5,22
14	13-16	BREX0514	5,35
17	16-18	BREX0517	8,15
20	19-21	BREX0519	6,52
26	25-27	BREX0525	7,41
31	30-32	BREX0532	8,41

Acoples GEKA

GEKA Fittings
Raccords GEKA
Raccordi GEKA

GEKA latón -Rosca hembra BSP

GEKA brass- Female thread BSP

GEKA laiton- Filetage femelle BSP

GEKA ottone - Filetto femmina BSP

THREAD ROSCA	Part n° Referencia	€
3/8"	BRGE0106	4,63
1/2"	BRGE0108	4,76
3/4"	BRGE0112	4,76
1"	BRGE0116	4,76
1"1/4	BRGE0120	6,85
1"1/2	BRGE0124	8,09



GEKA latón -Rosca macho BSP

GEKA brass- Male thread BSP

GEKA laiton- Filetage mâle BSP

GEKA ottone - Filetto maschio BSP

THREAD ROSCA	Part n° Referencia	€
3/8"	BRGE0206	4,63
1/2"	BRGE0208	4,63
3/4"	BRGE0212	4,76
1"	BRGE0216	4,76
1"1/4	BRGE0220	6,33
1"1/2	BRGE0224	7,83



GEKA latón -Tapón

GEKA brass- Plug

GEKA laiton- Bouchon

GEKA ottone - Tappo

DESCRIPTION DESCRIPCIÓN	Part n° Referencia	€
Plug	BRGE04	4,63



GEKA latón -Para manguera

GEKA brass- For hose

GEKA laiton- Pour tuyau

GEKA ottone - Per tubo

DN	Part n° Referencia	€
10	BRGE0510	4,57
13	BRGE0513	4,57
16	BRGE0516	4,89
19	BRGE0519	5,22
25	BRGE0525	6,72
32	BRGE0532	7,96
38	BRGE0538	10,24



Juntas NBR GEKA

NBR GEKA seals

Joints NBR GEKA

Guarnizioni NBR GEKA

DN	Part n° Referencia	€
for all sizes	NBRGE	0,42



Acoples CAMLOCK MORTERO

MORTAR CAMLOCK Fittings
Raccords MORTIER CAMLOCK
Raccordi CAMLOCK MORTAIO

CAMLOCK MORTERO Tipo A BSP

A Type MORTAR CAMLOCK BSP

CAMLOCK MORTIER Type A BSP

CAMLOCK MORTAIO Tipo A BSP



DN	SERIE	THREAD ROSCA	Part nº Referencia	€
25	22	1"	MT22A2516	18,42
27	22	1"	MT22A2716	18,42
35	22	1" 1/4	MT22A3520	25,11
35	22	1" 1/2	MT22A3524	25,11
50	22	2"	MT22A5032	31,43
35	23.5	1" 1/4	MT23A3520	25,11
35	23.5	1" 1/2	MT23A3524	25,11
50	23.5	2"	MT23A5032	31,43

CAMLOCK MORTERO Tipo C

C Type MORTAR CAMLOCK

CAMLOCK MORTIER Type C

CAMLOCK MORTAIO Tipo C



DN	SERIE	Part nº Referencia	€
27	22	MT22C2725	41,85
35	22	MT22C3535	49,08
50	22	MT22C5050	66,43
35	23.5	MT23C3535	49,08
50	23.5	MT23C5050	66,43

CAMLOCK MORTERO Tipo D BSP

D Type MORTAR CAMLOCK BSP

CAMLOCK MORTIER Type D BSP

CAMLOCK MORTAIO Tipo D BSP



DN	SERIE	THREAD ROSCA	Part nº Referencia	€
25	22	1"	MT22D2516	41,85
27	22	1"	MT22D2716	41,85
35	22	1" 1/4	MT22D3520	48,17
35	22	1" 1/2	MT22D3524	48,17
50	22	2"	MT22D5032	65,75
35	23.5	1" 1/4	MT23D3520	48,17
35	23.5	1" 1/2	MT23D3524	48,17
50	23.5	2"	MT23D5032	65,75

CAMLOCK MORTERO Tipo E

E Type MORTAR CAMLOCK

CAMLOCK MORTIER Type E

CAMLOCK MORTAIO Tipo E



DN	SERIE	Part nº Referencia	€
25	22	MT22E2525	20,93
27	22	MT22E2725	29,53
35	22	MT22E3535	29,75
50	22	MT22E5050	35,61
35	23.5	MT23E3535	20,93
50	23.5	MT23E5050	35,61

Acoples CHORRO DE ARENA

SANDBLAST Fittings
Raccords SABLAGE
Raccordi per SABBIATURA

CHORRO DE ARENA aluminio acople - para manguera

SANDBLAST aluminum -for hose

SABLAGE aluminium -pour le tuyau

Raccordo SABBIATURA alluminio -per tubo



DN	Part nº Referencia	€
19	ALCH0519	11,42
25	ALCH0525	11,42
32	ALCH0532	16,96
38	ALCH0538	24,20

CHORRO DE ARENA aluminio acople - rosca hembra BSP

SANDBLAST aluminum -Female thread BSP

SABLAGE aluminium -Filetage femelle BSP

Raccordo SABBIATURA alluminio -Filetto femmina BSP



THREAD ROSCA	Part nº Referencia	€
1" 1/4	ALCH0120	11,81
1" 1/2	ALCH0124	11,81

CHORRO DE ARENA latón acople - para manguera

SANDBLAST brass -for hose

SABLAGE laiton -pour le tuyau

Raccordo SABBIATURA ottone -per tubo



DN	Part nº Referencia	€
19	BRCH0519	47,42
25	BRCH0525	51,01
32	BRCH0532	77,62
38	BRCH0538	120,67

CHORRO DE ARENA latón acople - rosca hembra BSP

SANDBLAST brass -Female thread BSP

SABLAGE laiton -Filetage femelle BSP

Raccordo SABBIATURA ottone -Filetto femmina BSP



THREAD ROSCA	Part nº Referencia	€
1" 1/4	BRCH0120	52,25
1" 1/2	BRCH0124	52,25

CHORRO DE ARENA aluminio para manguera - rosca hembra BSP

SANDBLAST aluminum -for hose-Female thread BSP

SABLAGE aluminium -Filetage femelle BSP pour tuyau

Raccordo SABBIATURA alluminio -per tubo- Filetto femmina BSP



DN	THREAD ROSCA	Part nº Referencia	€
19	1" 1/4	ALCH071219	6,52
25	1" 1/4	ALCH071625	9,78
32	1" 1/4	ALCH072032	13,44
38	1" 1/4	ALCH072438	18,72

CHORRO DE ARENA latón para manguera - rosca hembra BSP

SANDBLAST brass -for hose-Female thread BSP

SABLAGE laiton -Filetage femelle BSP pour tuyau

Raccordo SABBIATURA ottone -per tubo- Filetto femmina BSP



DN	THREAD ROSCA	Part nº Referencia	€
19	1" 1/4	BRCH071219	39,59
25	1" 1/4	BRCH071625	56,29
32	1" 1/4	BRCH072032	74,43
38	1" 1/4	BRCH072438	100,84

Acoples CHORRO DE ARENA

SANDBLAST Fittings
Raccords SABLAGE
Raccordi per SABBIATURA

Industrial hoses

Industrial fittings

Stainless steel hose, welding fittings and flanges

Low pressure

Air conditioning hoses and fittings

CHORRO DE ARENA nylon acople - para manguera

SANDBLAST nylon for hose

SABLAGE nylon pour le tuyau

Raccordo SABBIATURA nylon per tubo



DN	Part n° Referencia	€
19	NYCH0519	20,17
25	NYCH0525	20,17
32	NYCH0532	20,17
38	NYCH0538	20,17

CHORRO DE ARENA nylon acople - rosca hembra BSP

SANDBLAST nylon female thread BSP

SABLAGE nylon filetage femelle BSP

Raccordo SABBIATURA nylon filetto femmina BSP



THREAD ROSCA	Part n° Referencia	€
1" 1/4	NYCH0120	18,26
1" 1/2	NYCH0124	18,26

CHORRO DE ARENA nylon para manguera - rosca hembra BSP

SANDBLAST nylon for hose female thread BSP

SABLAGE nylon filetage femelle BSP pour tuyau

Raccordo SABBIATURA nylon per tubo filetto femmina BSP



DN	THREAD ROSCA	Ø INNER Ø INT.	Part n° Referencia	€
25	1" 1/4 BSP	38.75	NYCH071625	19,98
32	1" 1/4 BSP	50.20	NYCH072032	19,95
38	1" 1/4 BSP	55.60	NYCH072438	19,03

Juntas NBR CHORRO DE ARENA

SANDBLAST NBR Seals

SABLAGE Joints NBR

SABBIATURA - Guarnizioni NBR



DN	Part n° Referencia	€
for all sizes	NBRCH	0,76

Acoples BAUER

BAUER Fittings
Raccords BAUER
Raccordi BAUER

BAUER acero kit

BAUER carbon steel kit

BAUER acier kit

BAUER acciaio kit



DN	ØRT	Part n° Referencia	€
2"	50	BE050	51,73
3"	76	BE076	70,85
4"	108	BE108	128,71

Hasta fin de existencias / Until end of stock / Jusqu'à la fin du stock / Fino ad esaurimento scorta

BAUER acero macho

BAUER carbon steel male

BAUER acier mâle

BAUER acciaio maschio



DN	ØRT	Part n° Referencia	€
2"	50	BEM050	39,95
3"	76	BEM076	56,15
4"	108	BEM108	96,04

BAUER acero hembra

BAUER carbon steel female

BAUER acier femelle

BAUER acciaio femmina



DN	ØRT	Part n° Referencia	€
2"	50	BEF050	11,78
3"	76	BEF076	14,70
4"	108	BEF108	32,67

Juntas NBR BAUER

NBR BAUER seals

Joints NBR BAUER

Guarnizioni NBR BAUER



DN	Part n° Referencia	€
2"	NBRBE050	2,72
3"	NBRBE076	5,65
4"	NBRBE108	9,80

Acoples PERROT

PERROT Fittings
Raccords PERROT
Raccordi PERROT

Industrial hoses

Industrial fittings

Stainless steel hose, welding fittings and flanges

Low pressure

Air conditioning hoses and fittings

PERROT acero kit

PERROT carbon steel kit

PERROT acier kit

PERROT acciaio kit



DN	Ø OUTER Ø EXT.	Part n° Referencia	€
2"	52.3	PE050	70,45
3"	77.4	PE089	112,32
4"	102.4	PE108	193,73

Hasta fin de existencias / Until end of stock / Jusqu'à la fin du stock / Fino ad esaurimento scorta

PERROT acero macho

PERROT carbon steel male

PERROT acier mâle

PERROT acciaio maschio



DN	Ø OUTER Ø EXT.	Part n° Referencia	€
2"	52.3	PEM050	18,92
3"	77.4	PEM089	31,37
4"	102.4	PEM108	67,18

PERROT acero hembra

PERROT carbon steel female

PERROT acier femelle

PERROT acciaio femmina



DN	Ø OUTER Ø EXT.	Part n° Referencia	€
2"	52.3	PEF050	51,53
3"	77.4	PEF089	80,95
4"	102.4	PEF108	126,54

Juntas NBR PERROT

NBR PERROT seals

Joints NBR PERROT

Guarnizioni NBR PERROT



DN	Part n° Referencia	€
2"	NBRPE050	3,65
3"	NBRPE089	3,65
4"	NBRPE108	6,52

Acoples vapor tipo BOSS

Steam fittings BOSS type
Raccords vapeur type BOSS
Raccordi per vapore tipo BOSS

BOSS acero kit BSP

BOSS carbon steel kit BSP

BOSS acier kit BSP

BOSS acciaio kit BSP



DN	THREAD ROSCA	Part nº Referencia	€
1/2"	1/2" BSP	BO0813	26,35
3/4"	3/4" BSP	BO1219	32,81
1"	1" BSP	BO1625	33,46
1"1/4	1" 1/4 BSP	BO2032	59,29
1"1/2	1" 1/2 BSP	BO2438	60,92
2"	2" BSP	BO3251	81,86



CONEXIÓN STD
+
CASQUILLO STD
+
MANGUERA
INDUS TrAle®

STD FITTINGS
+
STD FERRULES
+
HOSES
INDUS TrAle®



Acoples vapor EN 14423

Steam EN 14423 fittings
Raccords vappeur EN 14423
Raccordi per vapore EN 14423

Abrazadera EN 14423 acero

EN 14423 clamp steel

Collier EN 14423 acier

Collare EN 14423 acciaio



DN	Ø INNER Ø INT.	Part n° Referencia	€
13X6	24-26	AB06024026	17,87
19X7	32-34	AB06032034	23,80
25X7.5	39-41	AB06039041	38,85
32X8	47-50	AB06047050	48,84
38X8	53-56	AB06053056	65,30
50X9	67-69	AB06067069	76,93

Macho Espiga EN 14423 acero

Male-hose tail EN 14423 steel

Mâle à douille EN 14423 acier

Maschio con inserto EN 14423 acciaio



DN	THREAD ROSCA	Part n° Referencia	€
13	1/2" BSPT	STE0108	6,16
19	3/4" BSPT	STE0112	8,74
25	1" BSPT	STE0116	13,19
32	1" 1/4 BSPT	STE0120	22,86
38	1" 1/2 BSPT	STE0124	28,71
50	2" BSPT	STE0132	46,50

Hembra Espiga EN 14423 acero

Female-hose tail EN 14423 steel

Femelle à douille EN 14423 acier

Femmina con inserto EN 14423 acciaio



DN	THREAD ROSCA	Part n° Referencia	€
13	1/2" BSP	STE0208	9,67
19	3/4" BSP	STE0212	13,81
25	1" BSP	STE0216	20,91
32	1" 1/4 BSP	STE0220	30,12
38	1" 1/2 BSP	STE0224	40,02
50	2" BSP	STE0232	61,56

Accesorios industriales

Industrial accessories
Accessoires industriels
Accessori industriale

Campana aluminio para racor industrial - cierre 45°

Crimping Ferrule 45° closure (aluminium)

Jupe aluminium pour raccord industriel -fermeture 45°

Boccola in alluminio per raccordo industriale-chiusura 45°



Ø INNER Ø INT.	Part n° Referencia	€
11	ALCA011000	0,26
12.9	ALCA012900	0,26
13.4	ALCA013400	0,27
14.5	ALCA014500	0,29
15.5	ALCA015500	0,33
17.5	ALCA017500	0,35
18.5	ALCA018500	0,38
20.5	ALCA020500	0,44
21.5	ALCA021500	0,49
24.5	ALCA024500	0,58
26.5	ALCA026500	0,71
28.5	ALCA028500	0,87
30	ALCA030000	1,06
33	ALCA033000	1,28
36	ALCA036000	1,45
39	ALCA039000	1,83
46	ALCA046000	2,13
43	ALCA043000	2,16
48	ALCA048000	2,56
50	ALCA050000	4,50
54	ALCA054000	4,45
56.5	ALCA056500	7,18
63	ALCA063000	5,00
67	ALCA067000	11,02
84	ALCA083000	13,63
98	ALCA099000	14,34
123	ALCA121000	18,72

Abrazadera EN 14420-3 aluminio

Clamp EN 14420-3 aluminium

Collier EN 14420-3 aluminium

Collare EN 14420-3 aluminio



Ø HOSE Ø MANGUERA	Ø INNER Ø INT.	Part n° Referencia	€
13x5	21-25 mm	ALAB01021025	10,50
19X6	29-33 mm	ALAB01029033	10,65
25x5	34-37 mm	ALAB01034037	11,57
25x6	36-39 mm	ALAB01036039	11,57
32X5	41-44 mm	ALAB01041044	13,09
32x6	42-46 mm	ALAB01042046	13,09
38X5	47-51 mm	ALAB01047051	13,93
38X6.5	49-53 mm	ALAB01049053	13,93
38x8	52-56 mm	ALAB01052056	13,93
38x10	56-60 mm	ALAB01056060	13,93
50X5.5	62-64 mm	ALAB01060064	21,08
50x8	63-67 mm	ALAB01063067	21,08
50X10	68-72 mm	ALAB01068072	22,45
63x6	74-77 mm	ALAB01074077	28,08
63X8	77-81 mm	ALAB01077081	30,90
65x10	84-87 mm	ALAB01084087	39,57
75x6	87-90 mm	ALAB01087090	33,71
75x8	89-94 mm	ALAB01089094	36,53
75X10	94-98 mm	ALAB01094098	37,21
100x8	114-119 mm	ALAB01114119	70,24

Abrazadera EXPRESS acero

Clamp EXPRESS steel

Collier EXPRESS acier

Collare EXPRESS acciaio



Ø INNER Ø INT.	Part n° Referencia	€
19-21 mm	AB031921	1,24
22-24 mm	AB032224	1,30
25-27 mm	AB032527	1,37
28-30 mm	AB032830	1,63
31-33 mm	AB033133	2,02
34-36 mm	AB033436	3,46
37-39 mm	AB033739	4,37

Accesorios industriales

Industrial accessories
Accessoires industriels
Accessori industriale

Abrazadera tipo BOSS acero

Clamp BOSS type steel

Collier type BOSS acier

Collare tipo BOSS acciaio



Ø INNER Ø INT.	Nº BOLTS Nº TORNILLOS	Part nº Referencia	€
24-27 mm	2	AB05024027	4,17
30-33 mm	2	AB05030033	7,83
38-43 mm	2	AB05038043	15,98
38-43 mm	4	AB05438043	19,90
43-49 mm	4	AB05043049	17,48
54-60 mm	4	AB05054060	23,22
63-71 mm	4	AB05063071	28,77

Abrazadera DIN 20039 A acero

Clamp DIN 20039 A steel

Collier DIN 20039 A acier

Collare DIN 20039 A acciaio



Ø INNER Ø INT.	Part nº Referencia	€
22-29 mm	AB04022029	5,22
28-34 mm	AB04028034	5,48
32-40 mm	AB04032040	6,00

Abrazadera alta presión W1 acero

Clamp high pressure W1 steel

Collier haute pression W1 acier

Collare alta pressione W1 acciaio



Ø INNER Ø INT.	Part nº Referencia	€
17-19mm	AB02017019	1,36
20-22mm	AB02020022	1,37
23-25mm	AB02023025	1,38
26-28mm	AB02026028	1,40
29-31mm	AB02029031	1,49
32-35mm	AB02032035	1,52
36-39mm	AB02036039	1,54
40-43mm	AB02040043	1,57
44-47mm	AB02044047	1,88
48-51mm	AB02048051	1,91
52-55mm	AB02052055	1,94
56-59mm	AB02056059	1,98
60-63mm	AB02060063	2,02
64-67mm	AB02064067	2,09
68-73mm	AB02068073	2,75
74-79mm	AB02074079	2,83
80-85mm	AB02080085	2,92
86-91mm	AB02086091	3,02
92-97mm	AB02092097	3,08
98-103mm	AB02098103	3,16
104-112mm	AB02104112	3,25
113-121mm	AB02113121	3,32
122-130mm	AB02122130	3,37
131-139mm	AB02131139	4,77
140-148mm	AB02140148	5,03
149-161mm	AB02149161	5,22
162-174mm	AB02162174	5,52
175-187mm	AB02175187	5,67
188-200mm	AB02188200	5,97

Inox Corrugado

Stainless steel hose, welding fittings and flanges

Tuyau Inox, raccords et brides à souder

Tubi Inox, raccordi e flange a saldare

Manguera Inox

Stainless steel hose

Tuyau Inox

Tubi inox

167

Racores soldables

Welding fittings

Raccords à souder

Raccordi a saldare

169

Bridas soldables

Welding flanges

Brides à souder

Flange a saldare

175

3

Manguera Inox

Stainless steel hose

Tuyau Inox

Tubi inox

■ Mangueras Inox Corrugado y Malla Inox / Convuluted stainless steel hoses and AISI 304 Braid / Tuyaux inox onduleux et Tresse Inox / Tubi Inox corrugato e Maglia Inox | 167



M93211



M93161304



M93161



M93161304.EF



M93162304



M93212



M304



M3160

Racores soldables

Welding fittings
Raccords à souder
Raccordi a saldare

■ Racores soldables BSP /BSP Welding fittings /Raccords à souder BSP /Raccordi a saldare BSP | 169

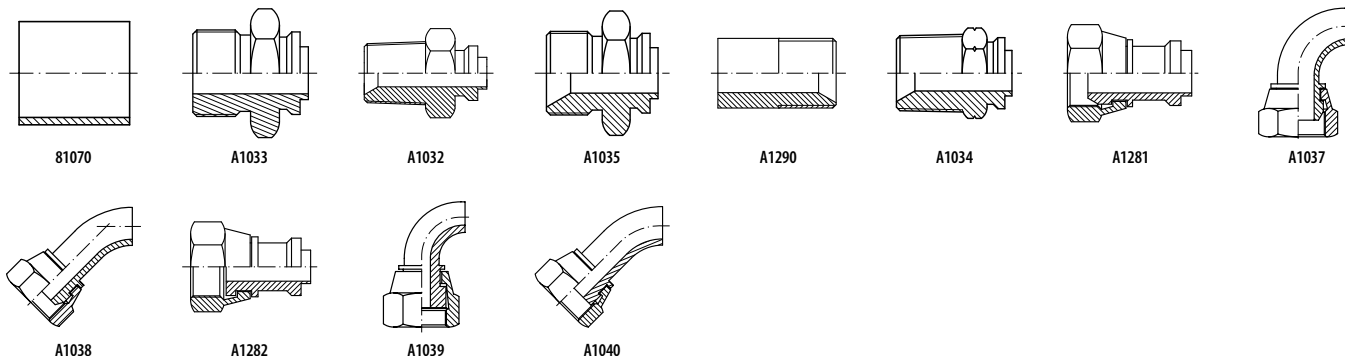

■ Racores soldables JIC 37° /JIC 37° Welding fittings /Raccords à souder JIC 37° /Raccordi a saldare JIC 37° | 171

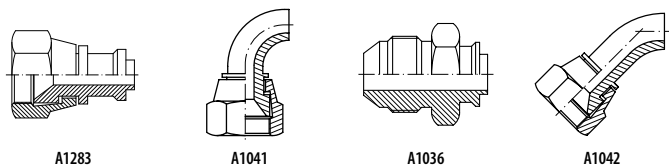

■ Racores soldables métricos /Metric Welding fittings /Raccords à souder métriques /Raccordi a saldare metrici | 172

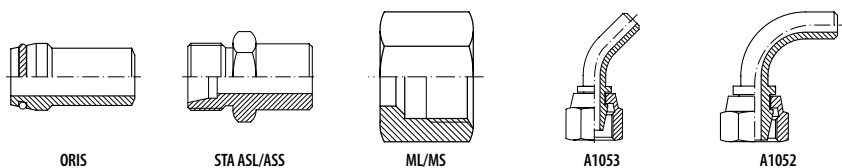

■ Cono y tuerca /Nipple and nut /Collet et écrou /Ogiva e dado | 174

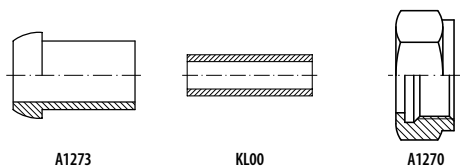

■ Racores para soldar >2" /Welding fittings >2" /Raccords à souder >2" /Raccordi a saldare > 2" | 174

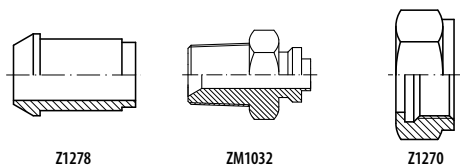

Industrial hoses

Industrial fittings

Stainless steel hose, welding fittings and flanges

Low pressure

Air conditioning hoses and fittings

Bridas soldables

Welding flanges
Brides à souder
Flange a saldare

- Bridas fijas para soldar / Fixed Forged flanges / Brides DIN à souder fixes / Flangia a saldare

| 175

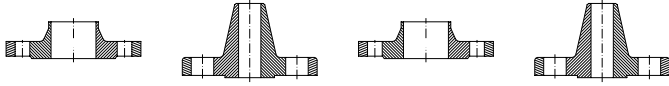

BPN162633

BANSAWN150

BPN402635

BANSAWN300

- Conjunto brida DIN 2642 / DIN 2642 swivel flanges set / Ensemble brides tournantes DIN 2642 / Flangia girevole DIN 2642

| 176

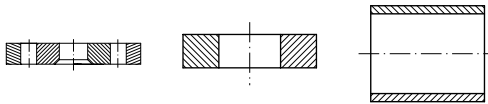

BPN102642

ABARO2642

ABTUB

- Conjunto brida DIN 2656 / DIN 2656 swivel flanges set / Ensemble brides tournantes DIN 2656 / Flangia girevole DIN 2656

| 177

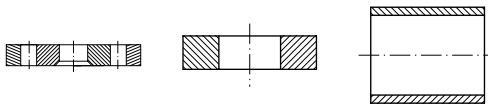

BPN402656

ABARO2656

ABTUB

- Conjunto brida ANSI-ASA / ANSI-ASA swivel flanges set / Ensemble brides ANSI-ASA / Flangia girevole ANSI-ASA

| 178

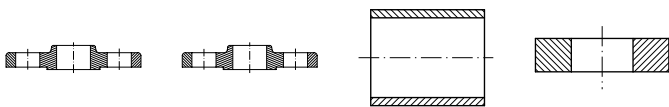

BANSAS0150

BANSAS0300

ABTUB

ABAROANSA

Manguera Inox

Stainless steel hose

Tuyau Inox

Tubi inox

Industrial hoses

Industrial fittings

Stainless steel hose, welding fittings and flanges

Low pressure

Air conditioning hoses and fittings

Inox corrugado AISI 321 con una malla AISI 304

Convuluted S.S. AISI 321 hose with one braid S.S. AISI 304

Inox onduleux AISI 321 avec une tresse inox AISI 304



Tubo in Inox corrugato 321 con una maglia AISI 304

DN	Ø INNER Ø INT.	Part n° Referencia	€
1/4"	6.2	M93211006	7,43
3/8"	10.3	M93211010	9,36
1/2"	12.2	M93211012	9,77
5/8"	16.2	M93211016	15,74
3/4"	20.2	M93211020	20,34
1"	25.4	M93211025	25,43
1" 1/4	34.3	M93211032	31,00
1" 1/2	40.1	M93211040	41,29
2"	50.3	M93211050	56,91
2" 1/2	65.6	M93211065	79,51
3"	80.3	M93211080	87,58
4"	100.8	M93211100	115,83

Inox corrugado AISI 316 con una malla AISI 304

Convuluted S.S. AISI 316 hose with one braid S.S. AISI 304

Inox onduleux AISI 316 avec une tresse inox AISI 304



Tubo in Inox corrugato 316 con una maglia AISI 304

DN	Ø INNER Ø INT.	Part n° Referencia	€
1/4"	6.2	M93161304006	7,43
3/8"	10.3	M93161304010	10,25
1/2"	12.2	M93161304012	10,90
3/4"	20.2	M93161304020	22,04
1"	25.4	M93161304025	28,33
1" 1/4	34.3	M93161304032	35,44
1" 1/2	40.1	M93161304040	48,03
2"	50.3	M93161304050	64,57
2" 1/2	65.6	M93161304065	90,81
3"	80.3	M93161304080	98,07
4"	100.8	M93161304100	133,59

Inox corrugado AISI 316 con una malla AISI 316

Convuluted S.S. AISI 316 hose with one braid S.S. AISI 316

Inox onduleux AISI 316 avec une tresse inox AISI 316



Tubo in Inox corrugato 316 con una maglia AISI 316

DN	Ø INNER Ø INT.	Part n° Referencia	€
1/4"	6.2	M93161006	8,07
3/8"	10.3	M93161010	11,70
1/2"	12.2	M93161012	12,92
3/4"	20.2	M93161020	27,04
1"	25.4	M93161025	35,11
1" 1/4	34.3	M93161032	45,20
1" 1/2	40.1	M93161040	64,57
2"	50.3	M93161050	86,37
2" 1/2	65.6	M93161065	104,93
3"	80.3	M93161080	113,01
4"	100.8	M93161100	157,40

Inox corrugado AISI 316 con una malla AISI 304 extra flexible

Convuluted S.S. AISI 316 hose with one braid S.S. AISI 304 extra flexible

Inox onduleux AISI 316 avec une tresse inox AISI 304 extra flexible



Tubo inox corrugato AISI 316 con una treccia inox AISI 304 extra flessibile

DN	Ø INNER Ø INT.	Part n° Referencia	€
3/4"	20	M93161304020EF	27,44
1"	25	M93161304025EF	34,71
1" 1/4	34.3	M93161304032EF	46,41
1" 1/2	39.8	M93161304040EF	63,77
2"	50	M93161304050EF	85,56

Inox corrugado AISI 316 con dos mallas AISI 304

Convuluted S.S. AISI 316 hose with two braids S.S. AISI 304

Inox onduleux AISI 316 avec deux tresses inox AISI 304



Tubo in Inox corrugato 316 con due maglie AISI 304

DN	Ø INNER Ø INT.	Part n° Referencia	€
1/4"	6.2	M93162304006	8,48
3/8"	10.3	M93162304010	12,27
1/2"	12.2	M93162304012	13,56
3/4"	20.2	M93162304020	28,33
1"	25.4	M93162304025	36,40
1" 1/4	34.3	M93162304032	47,46
1" 1/2	40.1	M93162304040	67,80
2"	50.3	M93162304050	90,69
2" 1/2	65.6	M93162304065	110,18
3"	80.3	M93162304080	118,66
4"	100.8	M93162304100	165,27

Manguera Inox

Stainless steel hose

Tuyau Inox

Tubi inox

Malla inox 304

AISI 304 braid

Tresse inox 304



Maglia di acciaio Inox 304

Ø INNER Ø INT.	Part nº Referencia	€
9,6	M304009.6	3,07
12,3	M304012.3	3,39
14,3	M304014.3	4,44
16,7	M304016.7	4,84
21,6	M304021.6	8,56
26,8	M304026.8	10,33
32,2	M304032.2	11,87
41,1	M304041.1	16,95
49,8	M304049.8	18,97
60,3	M304060.3	29,06
80,8	M304080.8	41,17

Malla inox 316

AISI 316 braid

Tresse inox 316



Maglia di acciaio Inox 316

Ø INNER Ø INT.	Part nº Referencia	€
9,6	M316009.6	4,04
12,3	M316012.3	4,44
14,3	M316014.3	5,65
16,7	M316016.7	6,46
21,6	M316021.6	11,30
26,8	M316026.8	13,56
32,2	M316032.2	15,74
41,1	M316041.1	22,44
49,8	M316049.8	27,85
60,3	M316060.3	37,94
80,8	M316080.8	50,45



Amplia variedad de manguera inoxidable corrugado para instalaciones en el sector químico, centrales eléctricas y plantas petroquímicas.

Wide range of convoluted stainless steel hoses for a variety of facilities, such as chemical sector, power plant, oil and gas.

Racores soldables

Welding fittings
Raccords à souder
Raccordi a saldare

Casquillo soldable Inox corrugado

Convuluted SS welding ferrule

Jupe à souder Inox convoluté

Boccola a saldare per inox corrugato

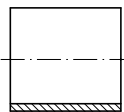

DN	Ø INNER Ø INT.	Part nº Referencia	€
1/4"	14	810700400	*
1/4"	12	810700401	*
3/8"	19	810700600	*
3/8"	17	810700601	*
1/2"	22	810700800	*
1/2"	19	810700801	*
5/8"	25	810701000	*
3/4"	30	810701200	*
3/4"	32	810701201	*
1"	35	810701500	*
1"	38	810701600	*
1"1/4"	47,8	810702000	*
1"1/4"	44,3	810702001	*
1"1/2"	56,3	810702400	*
2"	66	810703201	*
2"1/2"	84,9	810704000	*
2"1/2"	95,6	810704001	*
3"	100	810704801	*
4"	125	810706400	*

*Ver precio en catálogo de inox 173 / *Prices in Stainless Steel Catalogue p.173 / *Prix dans le Catalogue Acier Inox p.173 / *Prezzi in Acciaio Inossidabile p.173

Macho fijo BSP asiento plano - soldable con guía

Welding fixed male BSP flat seat with guide

Mâle fixe BSP fond plat à souder avec guide

Maschio BSP faccia piana, a saldare con guida

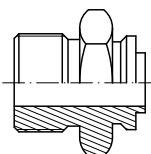

DN	THREAD ROSCA	Part nº Referencia	€
1/4"	1/4" BSP	A103304	1,84
3/8"	3/8" BSP	A103306	2,24
1/2"	1/2" BSP	A103308	2,93
3/4"	3/4" BSP	A103312	4,25
1"	1" BSP	A103316	6,93
1"1/4"	1"1/4 BSP	A103320	13,98
1"1/2"	1"1/2 BSP	A103324	18,19
2"	2" BSP	A103332	28,27

Macho cónico BSPT con guía

Welding adaptor BSPT with guide

Mamelon hexagonal BSPT conique à souder (bw) + guide

Maschio conico BSPT con guida

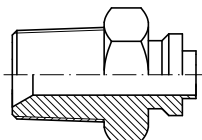

DN	THREAD ROSCA	Part nº Referencia	€
1/4"	1/4" BSPT	A103204	2,18
3/8"	3/8" BSPT	A103206	2,46
1/2"	1/2" BSPT	A103208	3,51
3/4"	3/4" BSPT	A103212	3,74
1"	1" BSPT	A103216	6,58
1"1/4"	1"1/4 BSPT	A103220	15,60
1"1/2"	1"1/2 BSPT	A103224	16,97
2"	2" BSPT	A103232	21,46
2"1/2"	2"1/2 BSPT	A103240	64,67

Macho BSP cono 60° con guía

Welding adaptor BSP 60° with guide

Mamelon hexagonal BSP à souder (bw) + guide

Maschio BSP a saldare sede 60° con guida

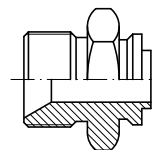

DN	THREAD ROSCA	Part nº Referencia	€
1/4"	1/4" BSP	A103504	1,24
3/8"	3/8" BSP	A103506	1,73
1/2"	1/2" BSP	A103508	2,13
3/4"	3/4" BSP	A103512	3,36
1"	1" BSP	A103516	4,86
1"1/4"	1"1/4 BSP	A103520	11,44
1"1/2"	1"1/2 BSP	A103524	16,12
2"	2" BSP	A103532	30,34

Empalme liso soldable rosca BSP (60°)

Welding union BSP male (60°)

Embout mâle lisse à souder gaz cyl BSP (60°)

Mezzo nipples tondo a saldare BSP 60°

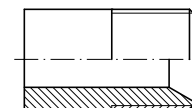

THREAD ROSCA	Part nº Referencia	€
1/8" BSP	A129002	1,36
1/4" BSP	A129004	0,79
3/8" BSP	A129006	1,00
1/2" BSP	A129008	1,22
3/4" BSP	A129012	2,22
1" BSP	A129016	5,16
1"1/4 BSP	A129020	15,41
1"1/2 BSP	A129024	16,87
2" BSP	A129032	16,71

Macho fijo NPT - soldable con guía

Welding fixed male NPT flat seat with guide

Mâle fixe NPT à souder avec guide

Maschio NPT, a saldare con guida

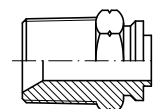

DN	THREAD ROSCA	Part nº Referencia	€
1/4"	1/4" NPT	A103404	1,52
3/8"	3/8" NPT	A103406	2,22
1/2"	1/2" NPT	A103408	2,51
3/4"	3/4" NPT	A103412	4,39
1"	1" NPT	A103416	6,71
1" 1/4	1" 1/4 NPT	A103420	13,05
1" 1/2	1" 1/2 NPT	A103424	16,12
2"	2" NPT	A103432	31,88

Racores soldables

Welding fittings
Raccords à souder
Raccordi a saldare

Hembras giratorias prensada BSP 60° - soldable con guía

Welding BSP swivel female 60° with guide

Femelle tournante BSP 60° à souder avec guide

Femmina diritta girevole BSP, a saldare con guida

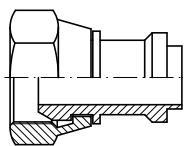

DN	THREAD ROSCA	Part n° Referencia	€
1/4"	1/4" BSP	A128104	1,60
3/8"	3/8" BSP	A128106	2,00
1/2"	1/2" BSP	A128108	2,85
3/4"	3/4" BSP	A128112	4,42
1"	1" BSP	A128116	6,93
1" 1/4	1" 1/4 BSP	A128120	11,79
1" 1/2	1" 1/2 BSP	A128124	15,46

Hembras giratorias prensada 90° BSP 60° - soldable

Welding 90° BSP swivel female 60°

Femelle tournante 90° à souder

Femmina 90° girevole BSP, a saldare

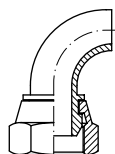

DN	THREAD ROSCA	Part n° Referencia	€
1/4"	1/4" BSP	A103704	2,52
3/8"	3/8" BSP	A103706	3,20
1/2"	1/2" BSP	A103708	5,30
3/4"	3/4" BSP	A103712	7,83
1"	1" BSP	A103716	12,68
1" 1/4	1" 1/4 BSP	A103720	19,23
1" 1/2	1" 1/2 BSP	A103724	27,68
2"	2" BSP	A103732	49,89

Hembras giratorias prensada 45° BSP 60° - soldable

Welding 45° BSP swivel female 60°

Femelle tournante 45° à souder

Femmina 45° girevole BSP, a saldare

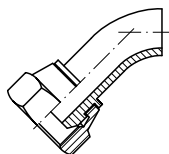

DN	THREAD ROSCA	Part n° Referencia	€
1/4"	1/4" BSP	A103804	2,56
3/8"	3/8" BSP	A103806	3,36
1/2"	1/2" BSP	A103808	4,80
3/4"	3/4" BSP	A103812	9,19
1"	1" BSP	A103816	11,62
1" 1/4	1" 1/4 BSP	A103820	18,68
1" 1/2	1" 1/2 BSP	A103824	27,68
2"	2" BSP	A103832	47,05

Hembras giratorias prensada BSP asiento plano - soldable con guía

Welding BSP swivel female flat seat

Femelle tournante BSP à souder fond plat

Femm. gir. BSP faccia piana, a saldare con guida

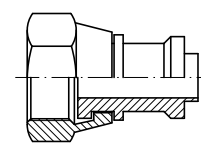

DN	THREAD ROSCA	Part n° Referencia	€
1/4"	1/4" BSP	A128204	1,79
3/8"	3/8" BSP	A128206	2,24
1/2"	1/2" BSP	A128208	3,85
3/4"	3/4" BSP	A128212	5,55
1"	1" BSP	A128216	9,31
1" 1/4	1" 1/4 BSP	A128220	16,82
1" 1/2	1" 1/2 BSP	A128224	24,60
2"	2" BSP	A128232	41,34

Hembras giratorias prensada 90° BSP asiento plano - soldable

Welding 90° BSP swivel female 60° flat seat

Femelle tournante 90° à souder fond plat

Femm. 90° gir. BSP faccia piana, a saldare



DN	THREAD ROSCA	Part n° Referencia	€
1/4"	1/4" BSP	A103904	2,95
3/8"	3/8" BSP	A103906	3,76
1/2"	1/2" BSP	A103908	5,37
3/4"	3/4" BSP	A103912	10,29
1"	1" BSP	A103916	11,62
1" 1/4	1" 1/4 BSP	A103920	20,92
1" 1/2	1" 1/2 BSP	A103924	30,99
2"	2" BSP	A103932	52,67

Hembras giratorias prensada 45° BSP asiento plano - soldable

Welding 45° BSP swivel female 60° flat seat

Femelle tournante 45° à souder fond plat

Femm. 45° gir. BSP faccia piana, a saldare

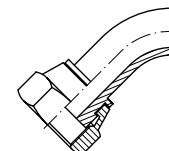

DN	THREAD ROSCA	Part n° Referencia	€
1/4"	1/4" BSP	A104004	3,13
3/8"	3/8" BSP	A104006	4,28
1/2"	1/2" BSP	A104008	5,82
3/4"	3/4" BSP	A104012	10,29
1"	1" BSP	A104016	11,62
1" 1/4	1" 1/4 BSP	A104020	20,92
1" 1/2	1" 1/2 BSP	A104024	30,99
2"	2" BSP	A104032	52,67

Racores soldables

Welding fittings
Raccords à souder
Raccordi a saldare

Industrial hoses

Industrial fittings

Stainless steel hose, welding fittings and flanges

Low pressure

Air conditioning hoses and fittings

Hembra giratoria prensada JIC 37° - soldable con guía

Welding crimped JIC 37° swivel female with guide

Embout à sertir femelle tournante JIC37° à souder

Femmina girevole JIC 37°, a saldare

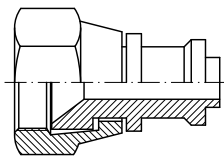

DN	THREAD ROSCA	Part nº Referencia	€
1/4"	7/16" 20h UNF	A12830704	1,49
1/4"	1/2" 20h UNF	A12830804	1,92
3/8"	9/16" 18h UNF	A12830906	2,08
3/8"	3/4" 16h UNF	A12831206	3,04
1/2"	3/4" 16h UNF	A12831208	3,04
1/2"	7/8" 14h UNF	A12831408	3,28
3/4"	1" 1/16 12h UNF	A12831712	4,96
1"	1" 5/16 12h UNF	A12832116	8,79
1" 1/4	1" 5/8 12h UNF	A12832620	14,54
1" 1/2	1" 7/8 12h UNF	A12833024	21,98

Hembra giratoria 90° prensada JIC 37° - soldable

Welding 90° JIC 37° swivel female

Femelle tournante 90° JIC 37° à souder

Femmina 90° girevole JIC 37°, a saldare

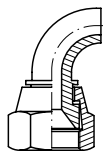

DN	THREAD ROSCA	Part nº Referencia	€
1/4"	7/16" 20h UNF	A10410704	2,68
1/4"	1/2" 20h UNF	A10410804	3,13
3/8"	9/16" 18h UNF	A10410906	3,76
1/2"	3/4" 16h UNF	A10411208	5,37
1/2"	7/8" 14h UNF	A10411408	6,11
3/4"	1" 1/16 12h UNF	A10411712	8,39
1"	1" 5/16 12h UNF	A10412116	13,99
1" 1/4	1" 5/8 12h UNF	A10412620	27,20
1" 1/2	1" 7/8 12h UNF	A10413024	38,92

Macho JIC 37° - soldable con guía

Welding JIC 37° male with guide

Mâle JIC 37° à souder avec guide

Maschio JIC 37° a saldare con guida

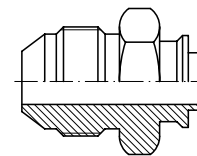

DN	THREAD ROSCA	Part nº Referencia	€
1/4"	7/16" 20h UNF	A10360704	1,49
1/4"	1/2" 20h UNF	A10360804	2,05
3/8"	9/16" 18h UNF	A10360906	1,75
3/8"	3/4" 16h UNF	A10361206	2,78
1/2"	3/4" 16h UNF	A10361208	2,65
1/2"	7/8" 14h UNF	A10361408	3,04
5/8"	7/8" 14h UNF	A10361410	3,41
3/4"	1" 1/16 12h UNF	A10361712	4,95
1"	1" 5/16 12h UNF	A10362116	10,23
1" 1/4	1" 5/8 12h UNF	A10362620	17,72
1" 1/4	1" 7/8 12h UNF	A10363020	22,99

Hembra giratoria 45° prensada JIC 37° - soldable

Welding 45° JIC 37° swivel female

Femelle tournante 45° JIC 37° à souder

Femmina 45° girevole JIC 37°, a saldare

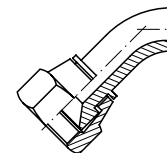

DN	THREAD ROSCA	Part nº Referencia	€
1/4"	7/16" 20h UNF	A10420704	2,95
1/4"	1/2" 20h UNF	A10420804	3,13
3/8"	9/16" 18h UNF	A10420906	3,85
1/2"	3/4" 16h UNF	A10421208	5,46
1/2"	7/8" 14h UNF	A10421408	6,80
3/4"	1" 1/16 12h UNF	A10421712	9,13
1"	1" 5/16 12h UNF	A10422116	14,46
1" 1/4	1" 5/8 12h UNF	A10422620	27,38
1" 1/2	1" 7/8 12h UNF	A10423024	40,26

Racores soldables

Welding fittings
Raccords à souder
Raccordi a saldare

Boquilla para soldar

Welding nipple

Collet cône Métrique (DIN 2353) à souder (BW)
o'ring

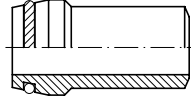

Ogiva a saldare

PIPE TUBO	SERIE	Part n° Referencia	€
15X2.5	L	ORIL 15	*
18X2.5	L	ORIL 18	*
22X2.5	L	ORIL 22	*
28X3	L	ORIL 28	*
35X4	L	ORIL 35	*
42X3	L	ORIL 42	*
6X2	L/S	ORIS 6	*
8X2	L/S	ORIS 8	*
8X1.5	L/S	ORIS 8X1.5	*
10X2	L/S	ORIS 10X2	*
12X2	L/S	ORIS 12	*
12X2.5	S	ORIS 12X2.5	*
14X2	L/S	ORIS 14X2	*
14X3	S	ORIS 14X3	*
16X2	S	ORIS 16X2	*
16X2.5	S	ORIS 16X2.5	*
16X3	S	ORIS 16X3	*
20X2.5	S	ORIS 20X2.5	*
20X3	S	ORIS 20X3	*
20X4	S	ORIS 20X4	*
25X4	S	ORIS 25X4	*
30x4	S	ORIS 30X4	*
30x5	S	ORIS 30X5	*
38x5	S	ORIS 38X5	*

*Ver precios en página 226 / *See prices page 226 / *Voir les prix page 226 / *Vedere prezzi p. 226

Racor recto para soldar

Weldable straight coupling

Raccord droit à souder

Raccordo diritto a saldare

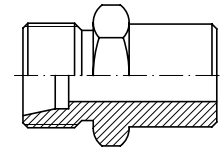

PIPE TUBO	SERIE	Part n° Referencia	€
6	L	STA ASL 6	*
8	L	STA ASL 8	*
10	L	STA ASL 10	*
12	L	STA ASL 12	*
15	L	STA ASL 15	*
18	L	STA ASL 18	*
22	L	STA ASL 22	*
28	L	STA ASL 28	*
35	L	STA ASL 35	*
42	L	STA ASL 42	*
6	S	STA ASS 6	*
8	S	STA ASS 8	*
10	S	STA ASS 10	*
12	S	STA ASS 12	*
14	S	STA ASS 14	*
16	S	STA ASS 16	*
20	S	STA ASS 20	*
25	S	STA ASS 25	*
30	S	STA ASS 30	*
38	S	STA ASS 38	*

*Ver precios en página 226 / *See prices page 226 / *Voir les prix page 226 / *Vedere prezzi p. 226

Tuerca Métrica DIN 3870

Nuts DIN 3870

Écrou Métrique DIN 3870

Dadi Metrici DIN 3870

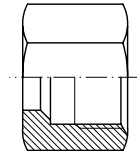

PIPE TUBO	SERIE	THREAD ROSCA	Part n° Referencia	€
4	LL	M8x1	MLL 4 M 8X1	*
6	LL	M10x1	MLL 6 M 10X1	*
8	LL	M12x1	MLL 8 M 12X1	*
6	L	M12x1,5	ML 6 M 12X1.5	*
8	L	M14x1,5	ML 8 M 14X1.5	*
10	L	M16x1,5	ML 10 M 16X1.5	*
12	L	M18x1,5	ML 12 M 18X1.5	*
15	L	M22x1,5	ML 15 M 22X1.5	*
18	L	M26x1,5	ML 18 M 26X1.5	*
22	L	M30x2	ML 22 M 30X2	*
28	L	M36x2	ML 28 M 36X2	*
35	L	M45x2	ML 35 M 45X2	*
42	L	M52x2	ML 42 M 52X2	*
6	S	M14x1,5	MS 6 M 14X1.5	*
8	S	M16x1,5	MS 8 M 16X1.5	*
10	S	M18x1,5	MS 10 M 18X1.5	*
12	S	M20x1,5	MS 12 M 20X1.5	*
14	S	M22x1,5	MS 14 M 22X1.5	*
16	S	M24x1,5	MS 16 M 24X1.5	*
20	S	M30x2	MS 20 M 30X2	*
25	S	M36x2	MS 25 M 36X2	*
30	S	M42x2	MS 30 M 42X2	*
38	S	M52x2	MS 38 M 52X2	*

*Ver precios en página 214 / *See prices page 214 / *Voir les prix page 214 / *Vedere prezzi p. 214

Racores soldables

Welding fittings
Raccords à souder
Raccordi a saldare

Hembra giratoria 45° prensada métrica - soldable

Metric weldable swivel female 45°

Femelle tournante 45° métrique à souder

Femmina girevole 45° metrica a saldare

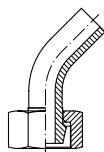

PIPE TUBO	SERIE	THREAD ROSCA	Part nº Referencia	€
6	L	12X1,5	A10531206	4,47
8	L	14x1,5	A10531408	2,63
10	L	16X1,5	A10531610	3,31
12	L	18X1,5	A10531812	3,28
15	L	22X1,5	A10532215	4,72
18	L	26X1,5	A10532618	7,14
22	L	30X2	A10533022	9,99
28	L	36X2	A10533628	18,79
35	L	45X2	A10534535	28,90
42	L	52X2	A10535242	47,60
6	S	14x1,5	A10531406	4,47
8	S	16X1,5	A10531608	3,40
10	S	18X1,5	A10531810	3,58
12	S	20X1,5	A10532012	4,47
14	S	22X1,5	A10532214	5,19
16	s	24x1,5	A10532416	5,59
20	S	30X2	A10533020	10,89
25	S	36X2	A10533625	15,66
30	S	42X2	A10534230	24,60
38	S	52X2	A10535238	39,37

Hembra giratoria 90° prensada métrica - soldable

Metric weldable swivel female 90°

Femelle tournante 90° métrique à souder

Femmina girevole 90° metrica a saldare

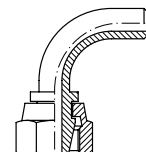

PIPE TUBO	SERIE	THREAD ROSCA	Part nº Referencia	€
6	L	12X1,5	A10521206	4,47
8	L	14X1,5	A10521408	2,95
10	L	16X1,5	A10521610	3,31
12	L	18X1,5	A10521812	3,58
15	L	22X1,5	A10522215	5,19
18	L	26X1,5	A10522618	7,99
22	L	30X2	A10523022	11,45
28	L	36X2	A10523628	18,79
35	L	45X2	A10524535	28,81
42	L	52X2	A10525242	47,60
6	S	14X1,5	A10521406	4,47
8	S	16X1,5	A10521608	3,31
10	S	18X1,5	A10521810	3,58
12	S	20X1,5	A10522012	4,00
14	S	22X1,5	A10522214	5,19
16	S	24X1,5	A10522416	5,59
20	S	30X2	A10523020	9,73
25	S	36X2	A10523625	15,66
30	S	42X2	A10524230	24,60
38	S	52X2	A10525238	39,37

Racores soldables

Welding fittings
Raccords à souder
Raccordi a saldare

Cono ajuste sin guía

Welding nipple without guide

Collet à souder sans guide

Ogiva a saldare BSP

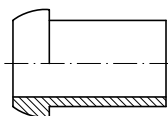

DN	THREAD ROSCA	Part nº Referencia	€
1/4"	1/4" BSP	A127304	0,55
3/8"	3/8" BSP	A127306	0,67
1/2"	1/2" BSP	A127308	1,20
3/4"	3/4" BSP	A127312	1,33
1"	1" BSP	A127316	2,31
1"1/4	1"1/4 BSP	A127320	3,32
1"1/2	1"1/2 BSP	A127324	6,14
2"	2" BSP	A127332	9,32

Espiga lisa métrica recta

Metric standpipe

Embout lisse métrique droit

Estremità tubolare diritta Metrica

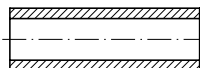

Ø OUTER Ø EXT.	Ø INNER Ø INT.	Part nº Referencia	€
10	7	KL0010	2,76
12	9	KL0012	3,44
14	10	KL0014	3,17
15	12	KL0015	2,82
16	12	KL0016	2,96
18	14	KL0018	3,63
20	14	KL0020	4,67
22	18	KL0022	4,70

Cono ajuste BSP 60° con guía >2"

Welding nipple with 60° cone for BSP nut with guide >2"

Collet à souder BSP cone 60° avec guide >2"

Ogiva a saldare cono 60° con guida per dado BSP >2"

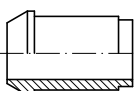

DN	THREAD ROSCA	Part nº Referencia	€
2"1/2	2"1/2 BSP	Z127840	*
3"	3" BSP	Z127848	*
4"	4" BSP	Z127864	*

Ver precios en Tarifa Inox p.178 / *Prices in Stainless Steel Catalogue p.178 / Prix dans le Catalogue Acier Inox p.178 / *Prezzi in Acciaio Inossidabile p.178

Macho BSPT soldar microfundido AISI-316 >2"

Micro-casting BSPT welding male AISI-316 >2"

Mâle BSPT à souder en acier moulé AISI-316 >2"

Maschio BSPT a saldare microfuso AISI-316 >2"

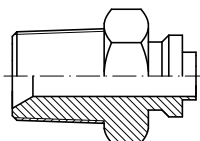

DN	THREAD ROSCA	Part nº Referencia	€
2"1/2	2"1/2 BSPT	ZM103240	*
3"	3" BSPT	ZM103248	*
4"	4" BSPT	ZM103264	*

*Ver precios en Tarifa Inox p.178 / *Prices in Stainless Steel Catalogue p.178 / *Prix dans le Catalogue Acier Inox p.178 / *Prezzi in Acciaio Inossidabile p.178

Tuerca para cono ajuste 60° BSP

BSP nut for welding nipple 60° cone

Écrou BSP pour collet à souder bw (60°)

Dado BSP per nipplo a saldare 60°

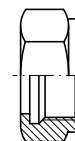

THREAD ROSCA	Part nº Referencia	€
1/4" BSP	A127004	0,94
3/8" BSP	A127006	0,94
1/2" BSP	A127008	1,28
3/4" BSP	A127012	1,68
1" BSP	A127016	3,11
1"1/4 BSP	A127020	6,00
1"1/2 BSP	A127024	9,17
2" BSP	A127032	12,46

Tuercas BSP Microfundido AISI-316 >2"

Micro-casting BSP nuts AISI-316 >2"

Écrous BSP en acier moulé AISI-316 >2"

Dadi BSP microfusi AISI-316 >2"

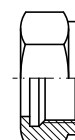

THREAD ROSCA	Part nº Referencia	€
2"1/2 BSP	Z127040	*
3" BSP	Z127048	*
4" BSP	Z127064	*

*Ver precios en Tarifa Inox p.178 / *Prices in Stainless Steel Catalogue p.178 / *Prix dans le Catalogue Acier Inox p.178 / *Prezzi in Acciaio Inossidabile p.178

Bridas soldables

Welding flanges
Brides à souder
Flange a saldare

Brida fija DIN 2633 PN 10/16

Fixed forged flange DIN 2633 PN 10/16

Bride fixe avec collerette DIN 2633 PN 10/16 à souder

Flangia fissa a saldare DIN 2633 PN 10/16

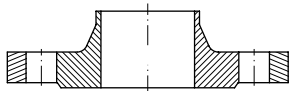

DN	Part n° Referencia	€
3/8"	BPN16263306	16,12
1/2"	BPN16263308	16,45
3/4"	BPN16263312	24,04
1"	BPN16263316	25,33
1"1/4	BPN16263320	27,31
1"1/2	BPN16263324	39,20
2"	BPN16263332	54,23
2"1/2	BPN16263340	59,56
3"	BPN16263348	66,93
4"	BPN16263364	83,63

Brida ANSI-ASA Neck 150 LBS

Flange ANSI-ASA w. Neck 150 LBS

Bride ANSI-ASA w. Neck 150 LBS

Flangia ANSI-ASA 150 LBS

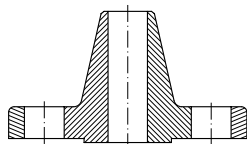

DN	Part n° Referencia	€
1/2"	BANSAWN15008	14,24
3/4"	BANSAWN15012	16,42
1"	BANSAWN15016	19,47
1"1/4	BANSAWN15020	23,91
1"1/2	BANSAWN15024	29,25
2"	BANSAWN15032	37,44
2"1/2	BANSAWN15040	48,12
3"	BANSAWN15048	54,06
4"	BANSAWN15064	76,47

Brida fija DIN 2635 PN 40

Fixed forged flange DIN 2635 PN 40

Bride fixe avec collerette DIN 2635 PN 40 à souder

Flangia fissa a saldare DIN 2635 PN 40

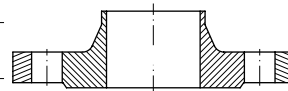

DN	Part n° Referencia	€
3/8"	BPN40263506	3,98
1/2"	BPN40263508	7,68
3/4"	BPN40263512	10,97
1"	BPN40263516	13,29
1"1/4	BPN40263520	18,19
1"1/2	BPN40263524	22,58
2"	BPN40263532	25,48
2"1/2	BPN40263540	48,06
3"	BPN40263548	58,63
4"	BPN40263564	54,71

Brida ANSI-ASA Neck 300 LBS

Flange ANSI-ASA w. Neck 300 LBS

Bride ANSI-ASA w. Neck 300 LBS

Flangia ANSI-ASA Neck 300 LBS

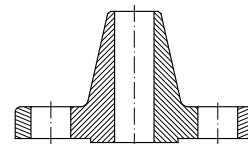

DN	Part n° Referencia	€
1/2"	BANSAWN30008	16,55
3/4"	BANSAWN30012	22,59
1"	BANSAWN30016	25,11
1"1/4	BANSAWN30020	29,15
1"1/2	BANSAWN30024	34,38
2"	BANSAWN30032	39,84
2"1/2	BANSAWN30040	43,42
3"	BANSAWN30048	83,92
4"	BANSAWN30064	128,66

Bridas soldables

Welding flanges
Brides à souder
Flange a saldare

Brida loca DIN 2642 PN 10/16

Swivel forged flange DIN 2642 PN 10/16

Bride plate tournante DIN 2642 PN 10/16 à souder

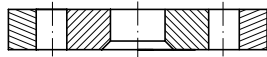

Flangia girevole a saldare DIN 2642 PN 10/16

DN	Part n° Referencia	€
3/8"	BPN10264206	8,20
1/2"	BPN10264208	8,99
3/4"	BPN10264212	10,40
1"	BPN10264216	13,44
1"1/4	BPN10264220	17,97
1"1/2	BPN10264224	19,90
2"	BPN10264232	24,14
2"1/2	BPN10264240	26,37
3"	BPN10264248	33,27
4"	BPN10264264	37,88

Aro para brida DIN 2642

Ring for flange DIN 2642

Collet épais pour bride DIN 2642

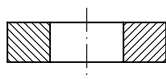

Anello per flangia DIN 2642

DN	Part n° Referencia	€
3/8"	ABARO264206	4,61
1/2"	ABARO264208	6,01
3/4"	ABARO264212	7,24
1"	ABARO264216	11,25
1"1/4	ABARO264220	14,58
1"1/2	ABARO264224	12,40
2"	ABARO264232	19,18
2"1/2	ABARO264240	18,72
3"	ABARO264248	25,27
4"	ABARO264264	59,54

Tubo soldar brida ANSI-DIN

Tube for welding flanges ANSI-DIN

Tube à souder brides ANSI-DIN

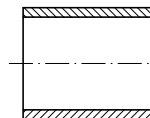

Tubo per flangia a saldare ANSI-DIN

DN	Part n° Referencia	€
3/8"	ABTUB006	2,29
1/2"	ABTUB008	2,58
3/4"	ABTUB012	3,09
1"	ABTUB016	3,95
1"1/4	ABTUB020	5,09
1"1/2	ABTUB024	6,10
2"	ABTUB032	7,58
2"1/2	ABTUB040	9,24
3"	ABTUB048	10,50
4"	ABTUB064	12,71

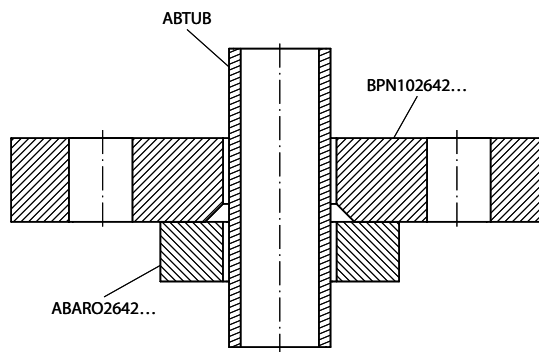

Bridas soldables

Welding flanges
Brides à souder
Flange a saldare

Brida loca DIN 2656 PN 40

Swivel forged flange DIN 2656 PN 40

Bride plate tournante DIN 2656 PN 40 à souder

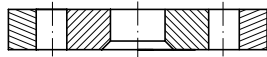

Flangia girevole a saldare DIN 2656 PN 40

DN	Part n° Referencia	€
3/8"	BPN40265606	6,00
1/2"	BPN40265608	6,57
3/4"	BPN40265612	10,48
1"	BPN40265616	13,10
1"1/4	BPN40265620	18,12
1"1/2	BPN40265624	23,96
2"	BPN40265632	28,82
2"1/2	BPN40265640	36,60
3"	BPN40265648	30,84
4"	BPN40265664	59,85

Aro para brida DIN 2656

Ring for flange DIN 2656

Collet épais pour bride DIN 2656

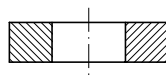

Anello per flangia DIN 2656

DN	Part n° Referencia	€
3/8"	ABARO265606	6,09
1/2"	ABARO265608	7,55
3/4"	ABARO265612	7,24
1"	ABARO265616	9,61
1"1/4	ABARO265620	10,24
1"1/2	ABARO265624	11,94
2"	ABARO265632	19,94
2"1/2	ABARO265640	21,48
3"	ABARO265648	33,46

Tubo soldar brida ANSI-DIN

Tube for welding flanges ANSI-DIN

Tube à souder brides ANSI-DIN

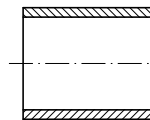

Tubo per flangia a saldare ANSI-DIN

DN	Part n° Referencia	€
3/8"	ABTUB006	2,29
1/2"	ABTUB008	2,58
3/4"	ABTUB012	3,09
1"	ABTUB016	3,95
1"1/4	ABTUB020	5,09
1"1/2	ABTUB024	6,10
2"	ABTUB032	7,58
2"1/2	ABTUB040	9,24
3"	ABTUB048	10,50
4"	ABTUB064	12,71

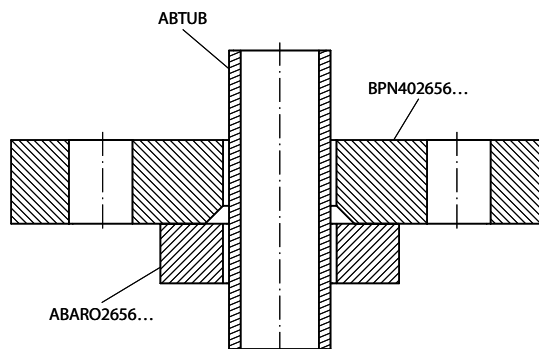

Bridas soldables

Welding flanges
Brides à souder
Flange a saldare

Brida loca ANSI-ASA 150 LBS

Swivel flange ANSI-ASA 150 LBS

Bride tourn. ANSI-ASA 150 LBS



Flangia ANSI-ASA 150 LBS

DN	Part n° Referencia	€
1/2"	BANSASO15008	10,86
3/4"	BANSASO15012	7,77
1"	BANSASO15016	8,16
1"1/4	BANSASO15020	10,76
1"1/2	BANSASO15024	18,97
2"	BANSASO15032	30,09
2"1/2	BANSASO15040	35,55
3"	BANSASO15048	42,70
4"	BANSASO15064	105,10

Brida loca ANSI-ASA 300 LBS

Swivel flange ANSI-ASA 300 LBS

Bride tourn. ANSI-ASA 300 LBS



Flangia ANSI-ASA 300 LBS

DN	Part n° Referencia	€
1/2"	BANSASO30008	11,50
3/4"	BANSASO30012	19,47
1"	BANSASO30016	22,31
1"1/4	BANSASO30020	17,70
1"1/2	BANSASO30024	26,58
2"	BANSASO30032	30,55
2"1/2	BANSASO30040	33,66
3"	BANSASO30048	47,17
4"	BANSASO30064	77,14

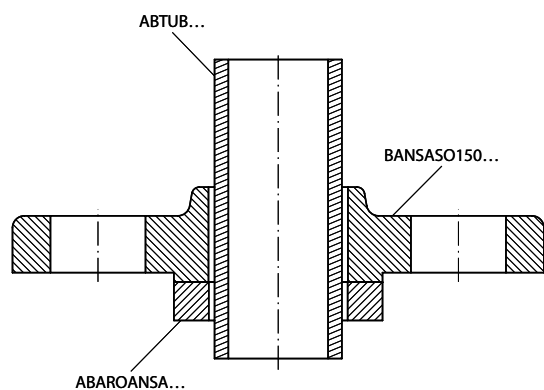

Tubo soldar brida ANSI-DIN

Tube for welding flanges ANSI-DIN

Tube à souder brides ANSI-DIN

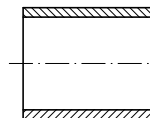

Tube per flangia a saldare ANSI-DIN

DN	Part n° Referencia	€
3/8"	ABTUB006	2,29
1/2"	ABTUB008	2,58
3/4"	ABTUB012	3,09
1"	ABTUB016	3,95
1"1/4	ABTUB020	5,09
1"1/2	ABTUB024	6,10
2"	ABTUB032	7,58
2"1/2	ABTUB040	9,24
3"	ABTUB048	10,50
4"	ABTUB064	12,71

Aro para brida ANSI-ASA 150/300 LBS

Ring for welding flanges ANSI-ASA 150/300 LBS

Collet épais pour bride ANSI-ASA 150/300 LBS

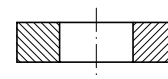

Anello per flangia ANSI-ASA 150/300 LBS

DN	Part n° Referencia	€
1/2"	ABAROANSA08	3,28
3/4"	ABAROANSA12	3,94
1"	ABAROANSA16	6,62
1"1/4	ABAROANSA20	5,89
1"1/2	ABAROANSA24	7,48
2"	ABAROANSA32	11,92
2"1/2	ABAROANSA40	16,01
3"	ABAROANSA48	21,01
4"	ABAROANSA64	33,57

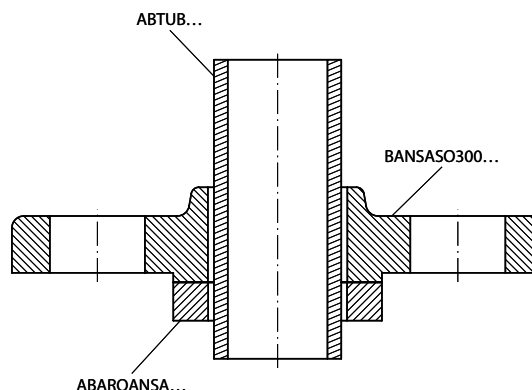

MANGUERAS ACERO INOXIDABLE *STAINLESS STEEL HOSES*

TALLER DE SOLDADURA
WELDING WORKSHOP

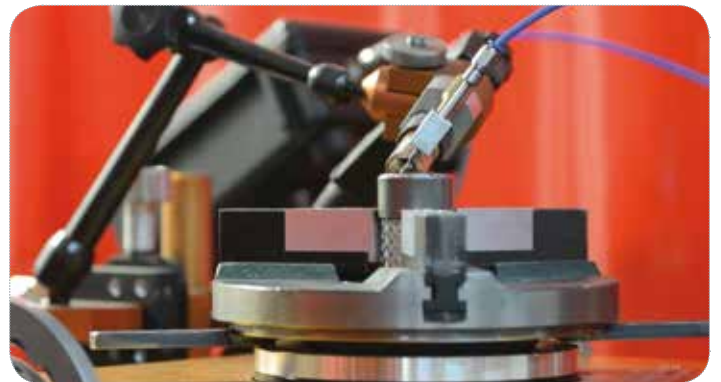

www.dicsaes.com

Baja presión

Low pressure

Basse pression

Tubi a bassa pressione

Mangueras baja presión

Low pressure hoses

Tuyaux basse pression

Tubi bassa pressione

183

Racores baja presión

Low pressure fittings

Raccords basse pression

Raccordi bassa pressione

184

4

Mangueras baja presión

Low pressure hoses
Tuyaux basse pression
Tubi bassa pressione

- Mangueras de caucho sintético / Synthetic rubber hoses (diesel oil) / Tuyaux de caoutchouc synthétique (gas-oil) / Tubi di caucciú sintético (diesel) | 183



M100



M110

Racores baja presión

Low pressure fittings
Raccords basse pression
Raccordi bassa pressione

- Casquillos (campanillas) / Sleeves / Jupes basse pression / Boccole | 184



A5010



ALCA

- Conexiones BSP / BSP Fittings / Embouts BSP basse pression / Raccordi BSP | 184



D5042



D5040



D5052



D5050



D5030



D5091

- Conexiones Métricas / Metric fittings / Embouts Métriques basse pression / Raccordi Metrici | 186



D5062



D5082



D5080



D5060



D5070



D5090



D5085



D5020

Mangueras baja presión

Low pressure hoses
Tuyaux basse pression
Tubi bassa pressione

Manguera de caucho sintético con una malla de acero galvanizado (gasoil)

Synthetic rubber hose with a galvanized steel braided (gasoil)

Tuyau de caoutchouc synthétique avec une tresse d'acier galvanisé (gasoil)

Tubo di caucciú sintético con una treccia di acciaio galvanizzato (gasolio)



Ø INNER Ø INT.	Part nº Referencia	€
5	M10005	4,73
6	M10006	5,46
7	M10007	5,80
8	M10008	6,59
9	M10009	7,49
12	M10012	10,73
14	M10014	12,10
15	M10015	14,11
18	M10018	17,77
20	M10020	18,85
22	M10022	21,41
26	M10025	24,99
30	M10030	31,48
40	M10040	77,24
50	M10050	102,69

Manguera de caucho sintético con una malla textil de alta tenacidad (gasoil y gasolina)

Synthetic rubber hose with a textile braided high toughness (gasoil and gasolina)

Tuyau de caoutchouc synthétique avec une tresse textile d'haute tenacité (gasoil et essence)

Tubo di caucciú sintético con una treccia tessile ad alta resistenza (gasolio e benzina)



Ø INNER Ø INT.	Part nº Referencia	€
4	M11004	4,40
5	M11005	4,80
6	M11006	5,56
7	M11007	6,25
8	M11008	6,08
9	M11009	7,76
12	M11012	11,81

Máquina prensar baja presión | Low pressure crimping machine | Presse basse pression | Macchina pressatubi bassa pressione

PBPH25PI



PBPH25



Mordazas incluidas | Included dies | Mors inclus | Morsetti inclusi
Ø10-13-16 mm.

Ø máx. | Ø max. | Ø max. | Ø massimo

25 mm.

Apertura | Opening | Overture | Apertura

+21 mm.

Peso | Weight | Poids | Peso

25 kg.

Dimensiones | Dimensions | Dimensions | Dimensioni

500 x 180 x 310 mm.

Alimentación neumática | Pneumatic input |

Alimentation Pneumatique | Alimentazione pneumatica

Máx. 7 bar.

Mordazas incluidas | Included dies | Mors inclus | Morsetti inclusi
Ø10-13-16 mm.

Ø máx. | Ø max. | Ø max. | Ø massimo

25 mm.

Apertura | Opening | Overture | Apertura

+21 mm.

Peso | Weight | Poids | Peso

12 kg.

Dimensiones | Dimensions | Dimensions | Dimensioni

500 x 180 x 310 mm.

Racores baja presión

Low pressure fittings
Raccords basse pression
Raccordi bassa pressione

Campana acero para manguera de baja presión

Sleeves for low pressure hose (steel)

Jupe acier doux malléable pour tuyau basse pression

Boccola in acciaio sottile per tubo bassa pressione



Ø OUTER Ø EXT.	Ø INNER Ø INT.	Part n° Referencia	€
11,6	10,5	A50101050000	0,28
13,7	12,4	A50101200000	0,32
14,7	13,5	A50101350000	0,35
15,6	14,5	A50101450000	0,35
16,5	15,5	A50101550000	0,38
18,8	17,3	A50101700000	0,44
19,5	18,5	A50101850000	0,46
22,9	20,5	A50102050000	0,56
23,9	22,5	A50102250000	0,64
26,2	24,5	A50102450000	0,73
28	26,4	A50102600000	0,74
30	28	A50102800000	0,90
32,2	30	A50103000000	1,44
35,5	33,5	A50103300000	1,46
38,2	36	A50103600000	1,61
45,2	42,2	A50104200000	5,30
60,8	56	A50105600000	6,55
65,5	61	A50106100000	8,28
70,3	66,5	A50106650000	11,33
76,7	71	A50107100000	12,68

Campana aluminio para racor industrial - cierre 45°

Crimping ferrule 45° closure (aluminium)

Jupe aluminium pour raccord industriel - fermeture 45°

Boccola alluminio per raccordo industriale - chiusura 45°



Ø INNER Ø INT.	Part n° Referencia	€
11	ALCA011000	*
12.9	ALCA012900	*
13.4	ALCA013400	*
14.5	ALCA014500	*
15.5	ALCA015500	*
17.5	ALCA017500	*
18.5	ALCA018500	*
20.5	ALCA020500	*
21.5	ALCA021500	*
24.5	ALCA024500	*
26.5	ALCA026500	*
28.5	ALCA028500	*
30	ALCA030000	*
33	ALCA033000	*
36	ALCA036000	*
39	ALCA039000	*
46	ALCA046000	*
43	ALCA043000	*
48	ALCA048000	*
50	ALCA050000	*
54	ALCA054000	*
56.5	ALCA056500	*
63	ALCA063000	*
67	ALCA067000	*
84	ALCA083000	*
98	ALCA099000	*
123	ALCA121000	*

*Ver precios en p.160 / *See prices in p.160 / *Prix à la p.160 / *Vedere prezzi p.160

Macho BSP rosca cilíndrica asiento cónico 60°

BSP Cylindrical male low pressure 60° cone

Embout mâle fixe BSP cône 60° basse pression

Maschio BSP cilindrica sede conica 60° bassa pressione



PIPE TUBO	THREAD ROSCA	Part n° Referencia	€
5-6	1/4"	D50420405000	2,38
7-8	1/4"	D50420407000	2,57
7-8	3/8"	D50420607000	2,47
9-10	3/8"	D50420609000	2,75
12-13	3/8"	D50420612000	3,07
12-13	1/2"	D50420812000	4,38
15-16	1/2"	D50420815000	3,16
15-16	3/4"	D50421216000	5,17
19-20	3/4"	D50421220000	5,03
19-20	1"	D50421620000	7,76
25	1"	D50421625000	6,89
30	1"1/4	D50422030000	20,89
40	1"1/2	D50422440000	27,64
50	2"	D50423250000	34,81

Macho BSP rosca cilíndrica asiento plano

Low pressure BSP cylindrical male flat seat

Embout mâle gaz fond plat basse pression

Maschio BSP cilindrico sede piana bassa pressione



PIPE TUBO	THREAD ROSCA	Part n° Referencia	€
5-6	1/8"	D50400205000	1,70
5-6	1/4"	D50400405000	2,38
7-8	1/4"	D50400407000	2,38
7-8	3/8"	D50400607000	2,46
9-10	3/8"	D50400609000	2,46
12-13	1/2"	D50400812000	3,16
15-16	1/2"	D50400815000	3,16
15-16	3/4"	D50401216000	5,17
19-20	3/4"	D50401220000	4,66
19-20	1"	D50401620000	7,76
25	1"	D50401625000	7,11
30	1"1/4	D50402030000	21,08
40	1"1/2	D50402440000	25,29
50	2"	D50403250000	34,81

Racores baja presión

Low pressure fittings
Raccords basse pression
Raccordi bassa pressione

Boquilla asiento cónico 60° (BSP) baja presión

BSP Nipple 60° cone low pressure

Nipple embout femelle BSP 60° basse pression

Inserto cono 60° BSP bassa pressione



DN	NUT TUERCA	Part n° Referencia	€
5-6	1/4"	D50520405000	1,30
7-8	1/4"	D50520407000	1,11
7-8	3/8"	D50520607000	1,33
9-10	3/8"	D50520609000	1,31
12-13	1/2"	D50520812000	1,64
15-16	1/2"	D50520815000	2,01
15-16	3/4"	D50521216000	2,22
19-20	3/4"	D50521220000	2,37
19-20	1"	D50521620000	4,24
25	1"	D50521625000	3,77
30	1"1/4	D50522030000	8,20
40	1"1/2	D50522440000	13,39
50	2"	D50523250000	21,71

Boquilla asiento plano (BSP) baja presión

BSP Nipple flat seat

Nipple embout femelle fond plat BSP basse pression

Inserto faccia piana BSP bassa pressione



PIPE TUBO	NUT TUERCA	Part n° Referencia	€
5-6	1/4"	D50500405000	1,30
7-8	1/4"	D50500407000	1,30
9-10	3/8"	D50500609000	1,33
12-13	1/2"	D50500812000	1,61
15-16	1/2"	D50500815000	1,77
15-16	3/4"	D50501216000	2,22
19-20	3/4"	D50501220000	2,05
19-20	1"	D50501620000	4,24
25	1"	D50501625000	3,77
30	1"1/4	D50502030000	8,52
40	1"1/2	D50502440000	16,44
50	2"	D50503250000	21,71

Tuerca BSP

BSP Nut

Ecrou BSP

Dado BSP



THREAD ROSCA	Part n° Referencia	€
1/4" BSP	D50300400000	0,84
3/8" BSP	D50300600000	0,90
1/2" BSP	D50300800000	1,44
3/4" BSP	D50301200000	1,95
1" BSP	D50301600000	3,41
1"1/4 BSP	D50302000000	7,51
1"1/2 BSP	D50302400000	8,88
2" BSP	D50303200000	16,58

Codo 90° baja gas cono 60°

90° BSP Swivel female 60° cone low pressure

Embout femelle 90° gaz cyl BSP 60° basse pression

Femmina a 90° sede 60° bassa pressione



PIPE TUBO	THREAD ROSCA	Part n° Referencia	€
5-6	1/4"	D50910405000	6,07
7-8	1/4"	D50910407000	5,02
9-10	3/8"	D50910609000	6,21
12-13	1/2"	D50910812000	8,91
15-16	1/2"	D50910815000	9,26
15-16	3/4"	D50911216000	17,90
19-20	3/4"	D50911220000	16,71
19-20	1"	D50911620000	27,94
25	1"	D50911625000	19,87
30	1"1/4	D50912030000	63,62

Racores baja presión

Low pressure fittings
Raccords basse pression
Raccordi bassa pressione

Macho rosca métrica asiento cónico 60° baja presión

Metric cylindrical male 60° cone

Embout mâle DIN métrique cône 60° basse pression

Maschio Metrico sede conica 60° bassa pressione



PIPE TUBO	THREAD ROSCA	Part nº Referencia	€
5-6	10X1	D50621005000	2,38
7-8	12X1,5	D50621207000	2,60
9-10	14X1,5	D50621409000	2,86
9-10	16X1,5	D50621609000	3,22
12-13	16X1,5	D50621612000	3,64
9-10	18X1,5	D50621810000	3,78
12-13	22X1,5	D50622212000	4,69
15-16	22X1,5	D50622215000	4,85
12-13	26X1,5	D50622612000	5,41
15-16	26X1,5	D50622615000	5,41

Macho rosca métrica asiento plano baja presión

Metric cyl male flat seat low pressure

Embout mâle métrique fond plat basse pression

Maschio Metrico sede piana bassa pressione



PIPE TUBO	THREAD ROSCA	Part nº Referencia	€
5-6	10X1	D50601005000	2,39
7-8	12X1,5	D50601207000	2,60
9-10	14X1,5	D50601409000	2,86
9-10	16X1,5	D50601609000	3,25
12-13	16X1,5	D50601612000	3,61
9-10	18X1,5	D50601810000	4,00
12-13	22X1,5	D50602212000	3,79
15-16	22X1,5	D50602215000	3,37
12-13	26X1,5	D50602612000	5,41
15-16	26X1,5	D50602615000	5,41

Boquilla asiento cónico 60° (Métrica) baja presión

Metric nipple 60° cone low pressure

Nipple pour embout femelle DIN métrique cône 60° basse pression

Inserto cono 60° Metrico bassa pressione



PIPE TUBO	NUT TUERCA	Part nº Referencia	€
5-6	10X1	D50821005000	1,39
7-8	12X1,5	D50821207000	1,60
9-10	14X1,5	D50821409000	1,60
8-9	16X1,5	D50821609000	1,72
9-10	18X1,5	D50821810000	2,10
12-13	22X1,5	D50822212000	2,52
15-16	22X1,5	D50822215000	2,52
12-13	26X1,5	D50822612000	3,86
15-16	26X1,5	D50822615000	3,86

Boquilla asiento plano (Métrica) baja presión

Metric nipple flat seat low pressure

Nipple pour embout femelle métrique fond plat basse pression

Inserto faccia piana bassa pressione



PIPE TUBO	NUT TUERCA	Part nº Referencia	€
5-6	10X1	D50801005000	1,39
7-8	12X1,5	D50801207000	1,54
9-10	14X1,5	D50801409000	1,60
9-10	16X1,5	D50801609000	1,42
9-10	18X1,5	D50801810000	2,22
12-13	22X1,5	D50802212000	2,52
15-16	22X1,5	D50802215000	1,68
12-13	26X1,5	D50802612000	3,86
15-16	26X1,5	D50802615000	3,86

Tuerca Métrica

Metric nut

Écrou métrique

Dado Metrico



THREAD ROSCA	Part nº Referencia	€
10X1	D50701000000	0,98
12X1,5	D50701200000	1,11
14X1,5	D50701400000	1,39
16X1,5	D50701600000	1,39
18X1,5	D50701800000	1,62
22X1,5	D50702200000	2,68
26X1,5	D50702600000	3,10

Boquilla en codo 90° asiento cónico 60° (métrica) baja presión

Nipple in 90° metric swivel female tapered seat low pressure 60°

Nipple en embout femelle 90° DIN métrique cône 60° basse pression

Femmina a 90° Metrica sede conica 60°



PIPE TUBO	THREAD ROSCA	Part nº Referencia	€
5-6	10X1	D50901006000	6,93
7-8	12X1,5	D50901207000	10,55
9-10	14X1,5	D50901409000	8,44
9-10	16X1,5	D50901609000	8,45

Racores baja presión

Low pressure fittings
Raccords basse pression
Raccordi bassa pressione

Espiga lisa métrica baja presión

Metric standpipe low pressure

Embout lisse métrique basse pression



Estremità tubolare Metrica bassa pressione

PIPE TUBO		Part nº Referencia	€
5-6	4	D50850405000	5,14
5-6	6	D50850606000	2,93
5-6	8	D50850806000	2,93
7-8	8	D50850808000	2,93
7-8	10	D50851008000	3,15
9-10	10	D50851010000	3,15
12-13	12	D50851212000	3,31
15,5	15	D50851515000	5,22
15-16	18	D50851815000	5,50

Orientable métrico baja presión

Low pressure metric banjo

Embout banjo métrique basse pression



Raccordo ad occhio Metrico bassa pressione

PIPE TUBO	Ø	Part nº Referencia	€
5-6	8	D50200805	4,03
7-8	8	D50200807	4,03
5-6	10	D50201005	4,42
7-8	10	D50201007	4,42
9-10	10	D50201009	4,49
5-6	12	D50201205	4,60
7-8	12	D50201207	4,60
9-10	12	D50201209	4,60
5-6	14	D50201405	4,74
7-8	14	D50201407	4,74
9-10	14	D50201409	4,74

Aire acondicionado

Air conditioning hoses and fittings

Climatisation

Aria condizionata

Manguera aire acondicionado

Air conditioning hose

Tuyau Freon

Tube Freon

193

Racores aire acondicionado

Air conditioning fittings

Raccords climatisation

Raccordi aria condizionata

194

5

Manguera aire acondicionado

Air conditioning hose

Tuyau Freon

Tube Freon

- Mangueras Freón / Air conditioning hose / Tuyau Freon / Tubo Freon



M5200



MSB25

Racores aire acondicionado

Air conditioning fittings
Raccords climatisation
Raccordi aria condizionata

- Rotalock sin válvula / Rotalock without valve / Raccords Rotalock sans vanne / Raccordi Rotalock senza valvola | 194



- Rotalock con válvula / Rotalock with valve / Raccords Rotalock avec vanne / Raccordi Rotalock con valvola | 194



- Racores de unión / Couplings / Raccord union / Raccordi di unione | 194



- Hembras con junta tórica sin válvula / Swivel female with green joint / Femelles tournantes avec joint vert sans vanne / Femmine con o'ring senza valvola | 195



- Hembras con junta tórica con válvula / Swivel female with green joint with valve / Femelles tournantes avec joint vert et avec vanne / Femmine con o'ring e valvola | 195



- Machos con junta tórica / Males with green joint / Mâles avec joint vert / Maschi con o'ring | 196



- Conexiones rosca SAE / Swivel females SAE / Femelles tournantes SAE / Raccordi SAE | 196



- Conexiones con válvula para Freón 12 / Fittings with valve for air conditioning 12 / Embouts climatisation pour Freón 12 avec vanne / Raccordi con valvola per Freon 12 | 197



Racores aire acondicionado

Air conditioning fittings
Raccords climatisation
Raccordi aria condizionata

- Juntas tóricas y racores recuperables / Joints and reusable fittings / Joints toriques et raccords récupérables / O'ring e raccordi recuperabili



*FREON



CRF

Manguera aire acondicionado

Air conditioning hose

Tuyau Freon

Tube Freon

Industrial hoses

Industrial fittings

Stainless steel hose, welding fittings and flanges

Low pressure

Air conditioning hoses and fittings

Freón DAYCO

Air conditioning DAYCO

Tuyaux Freon DAYCO

Freon DAYCO



DN		Part nº Referencia	€
5/16"	8	M520006	15,58
13/32"	10	M520008	21,65
1/2"	13	M520010	24,89
5/8"	16	M520012	31,43

Freón TrΔle

Air conditioning TrΔle

Tuyaux Freon TrΔle

Freon TrΔle



DN		Part nº Referencia	€
5/16"	8	MSB2506	12,90
13/32"	10	MSB2508	13,20
1/2"	12	MSB2510	15,30
5/8"	16	MSB2512	16,50

Mangueras Freón Barrier N (polivalente) Freón 134, 12...

Air Conditioning Barrier N Hose Freon 134, 12...



SAE J51
SAE J2064



-30 / 95 °C

- Está compuesta por Nitrilo, Nylon y Neopreno. Cubierta exterior de EPDM resistente al calor, abrasión y al exterior.

Tube: Nitrile, Nylon and Neoprene. Outer cover of EPDM, heat, abrasion and ozone resistant.

- Refrigerantes / refrigerants
HFC-134a / CFC-12

- Prensas eléctricas
Electric crimping machine

- Prensa manual
Manual crimping machine

- Prensa Freón. Ref. V001040 (sin juegos de mordazas)
Air conditioning hose crimping machine (without clamps)

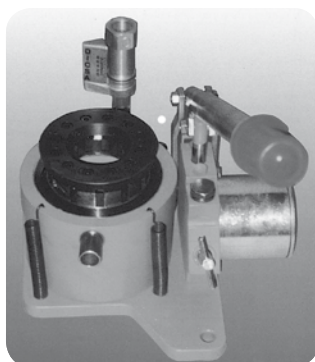

Disponemos de garras de freón para las prensas
SE 25 - PE 25 / 28 / 32 / 38 / 50 / 58 / 4-50 - PE 180 - PES 50...
We have air conditioning clamps for the following machines
SE 25 - PE 25 / 28 / 32 / 38 / 50 / 58 / 4-50 - PE 180 - PES 50...

Racores aire acondicionado

Air conditioning fittings
Raccords climatisation
Raccordi aria condizionata

Hembra recta con junta Rotalock

Straight female with Rotalock joint

Femelle climatisation droite Rotalock avec raccord tube "o" compresseur



Femmina diritta con guarnizione Rotalock

DN	THREAD ROSCA	Part n° Referencia	€
13/32"	1" 14h UNS	FXR 1108	12,88
1/2"	1" 14h UNS	FXR 1110	13,34
5/8"	1" 14h UNS	FXR 1112	19,17

Hembra 45° con junta Rotalock

45° Female with Rotalock joint

Femelle climatisation 45° Rotalock avec raccord tube 45° "o" compresseur



Femmina a 45° con guarnizione Rotalock

DN	THREAD ROSCA	Part n° Referencia	€
13/32"	1" 14h UNS	FX45 1108	14,26
1/2"	1" 14h UNS	FX45 1110	15,34
5/8"	1" 14h UNS	FX45 1112	21,78

Hembra 90° con junta Rotalock

90° Female with Rotalock joint

Femelle climatisation 90° Rotalock avec raccord tube 90° "o" compresseur



Femmina a 90° con guarnizione Rotalock

DN	THREAD ROSCA	Part n° Referencia	€
13/32"	1" 14h UNS	FX90 1108	14,42
1/2"	1" 14h UNS	FX90 1110	15,34
5/8"	1" 14h UNS	FX90 1112	21,93

Hembra especial 90° con junta Rotalock

90° Special female with Rotalock joint

Femelle climatisation spéciale 90° Rotalock avec raccord tube 90° spécial "o" compresseur



Femmina a 90° speciale con guarnizione Rotalock

DN	THREAD ROSCA	Part n° Referencia	€
13/32"	1" 14h UNS	FXA90 1108	22,55
1/2"	1" 14h UNS	FXA90 1110	22,85

Hembra recta con junta Rotalock y válvula 134

Straight female with Rotalock joint and 134 valve

Femelle droite Rotalock avec joint et vanne pour 134



Femmina diritta con guarnizione Rotalock e valvola 134

DN	THREAD ROSCA	Part n° Referencia	€
13/32"	1" 14h UNS	134 FXRV 1108	23,47
1/2"	1" 14h UNS	134 FXRV 1110	24,08
5/8"	1" 14h UNS	134 FXRV 1112	26,53

Hembra 90° con junta Rotalock y válvula 134

90° Female with Rotalock joint and 134 valve

Femelle 90° Rotalock avec joint et vanne pour 134



Femmina a 90° con guarnizione Rotalock e valvola 134

DN	THREAD ROSCA	Part n° Referencia	€
13/32"	1" 14h UNS	134 FX90V 1108	24,69
1/2"	1" 14h UNS	134 FX90V 1110	25,31
5/8"	1" 14h UNS	134 FX90V 1112	29,29

Hembra 45° con junta Rotalock y válvula 134

45° Female with Rotalock joint and 134 valve

Femelle 45° Rotalock avec joint et vanne pour 134



Femmina a 45° con guarnizione Rotalock e valvola 134

DN	THREAD ROSCA	Part n° Referencia	€
13/32"	1" 14h UNS	134 FX45V 1108	26,23
1/2"	1" 14h UNS	134 FX45V 1110	25,15

Hembra especial 90° con junta Rotalock y válvula 134

90° special Female with Rotalock joint and 134 valve

Femelle climatisation spéciale 90° Rotalock avec joint et vanne pour 134



Femmina a 90° speciale con guarnizione Rotalock e valvola 134

DN	THREAD ROSCA	Part n° Referencia	€
13/32"	1" 14h UNS	134 FXAV90 1108	30,06
1/2"	1" 14h UNS	134 FXAV90 1110	30,37

Racor de unión con válvula 134

134 valve coupling

Raccord d'union climatisation avec vanne pour splicer vanne pour 134



Raccordo di unione tubi con valvola 134

DN	Part n° Referencia	€
5/16"	134 URTV 0006	23,77
13/32"	134 URTV 0008	25,31
1/2"	134 URTV 0010	25,46
5/8"	134 URTV 0012	25,77

Racor de unión

Hose-hose coupling

Raccord d'union climatisation splicer



Raccordo di unione tubo-tubo

DN	Part n° Referencia	€
5/16"	URT 0006	10,89
13/32"	URT 0008	11,20
1/2"	URT 0010	12,73
5/8"	URT 0012	13,34

Racores aire acondicionado

Air conditioning fittings
Raccords climatisation
Raccordi aria condizionata

Industrial hoses

Industrial fittings

Stainless steel hose, welding fittings and flanges

Low pressure

Air conditioning hoses and fittings

Hembra giratoria recta con junta verde

Straight swivel female with green joint

Femelle tournante avec joint vert

Femmina diritta con o'ring verde



DN	THREAD ROSCA	Part n° Referencia	€
5/16"	5/8" 18h UNF	FOR 0606	9,05
13/32"	3/4" 16h UNF	FOR 0808	9,66
1/2"	7/8" 14h UNF	FOR 1010	11,04
5/8"	7/8" 14h UNF	FOR 1012	12,27
5/8"	1"1/16 12h UNF	FOR 1212	14,57

Hembra giratoria 90° con junta verde

90° swivel female with green joint

Femelle tournante 90° avec joint vert

Femmina a 90° con o'ring verde



DN	THREAD ROSCA	Part n° Referencia	€
5/16"	5/8" 18h UNF	FO90 0606	10,28
13/32"	3/4" 16h UNF	FO90 0808	10,89
1/2"	7/8" 14h UNF	FO90 1010	11,81
5/8"	7/8" 14h UNF	FO90 1012	12,88
5/8"	1"1/16 12h UNF	FO90 1212	15,64

Hembra giratoria 45° con junta verde

45° swivel female with green joint

Femelle tournante 45° avec joint vert

Femmina a 45° con o'ring verde



DN	THREAD ROSCA	Part n° Referencia	€
5/16"	5/8" 18h UNF	FO45 0606	9,97
13/32"	3/4" 16h UNF	FO45 0808	10,89
1/2"	7/8" 14h UNF	FO45 1010	11,81
5/8"	7/8" 14h UNF	FO45 1012	12,88
5/8"	1"1/16 12h UNF	FO45 1212	15,64

Hembra giratoria recta con válvula

Straight swivel female with green joint and valve

Femelle tournante avec joint vert et vanne pour 134

Femmina diritta con o'ring verde e valvola 134



DN	THREAD ROSCA	Part n° Referencia	€
5/16"	5/8" 18h UNF	FORV 0606	19,63
13/32"	3/4" 16h UNF	FORV 0808	20,25
1/2"	7/8" 14h UNF	FORV 1010	20,86
5/8"	7/8" 14h UNF	FORV 1012	22,09
5/8"	1"1/16 12h UNF	FORV 1212	25,00

Hembra giratoria 45° con válvula

45° Swivel female with green joint and valve

Femelle tournante 45° avec joint vert et vanne pour 134

Femmina a 45° con o'ring verde e valvola 134



DN	THREAD ROSCA	Part n° Referencia	€
5/16"	5/8" 18h UNF	FO45V 0606	20,71
13/32"	3/4" 16h UNF	FO45V 0808	21,63
1/2"	7/8" 14h UNF	FO45V 1010	22,09
5/8"	7/8" 14h UNF	FO45V 1012	22,85
5/8"	1"1/16 12h UNF	FO45V 1212	27,45

Hembra giratoria 90° con válvula

90° Swivel female with green joint and valve

Femelle tournante 90° avec joint vert et vanne pour 134

Femmina a 90° con o'ring verde e valvola 134



DN	THREAD ROSCA	Part n° Referencia	€
5/16"	5/8" 18h UNF	FO90V 0606	21,78
13/32"	3/4" 16h UNF	FO90V 0808	22,70
1/2"	7/8" 14h UNF	FO90V 1010	22,85
5/8"	7/8" 14h UNF	FO90V 1012	22,85
5/8"	1"1/16 12h UNF	FO90V 1212	27,61

Racores aire acondicionado

Air conditioning fittings
Raccords climatisation
Raccordi aria condizionata

Macho recto con junta tórica

Straight male with green joint

Mâle tournant avec joint vert



Maschio diritto con o'ring

DN	THREAD ROSCA	Part nº Referencia	€
5/16"	5/8" 18h UNF	MOR 0606	9,05
13/32"	3/4" 18h UNF	MOR 0808	9,66
1/2"	7/8" 18h UNF	MOR 1010	11,50
5/8"	7/8" 18h UNF	MOR 1012	13,25
5/8"	1"1/16 16h UNF	MOR 1212	14,88

Macho 90° con junta tórica

90° Male with green joint

Mâle tournant 90° avec joint vert



Maschio a 90° con o'ring

DN	THREAD ROSCA	Part nº Referencia	€
5/16"	5/8" 18h UNF	MO90 0606	10,28
13/32"	3/4" 18h UNF	MO90 0808	11,04
1/2"	7/8" 18h UNF	MO90 1010	12,58
5/8"	7/8" 18h UNF	MO90 1012	14,11
5/8"	1"1/16 16h UNF	MO90 1212	16,26

Macho 45° con junta tórica

45° Male with green joint

Mâle tournant 45° avec joint vert



Maschio a 45° con o'ring

DN	THREAD ROSCA	Part nº Referencia	€
5/16"	5/8" 18h UNF	MO45 0606	10,28
13/32"	3/4" 18h UNF	MO45 0808	10,89
1/2"	7/8" 18h UNF	MO45 1010	12,27
5/8"	7/8" 18h UNF	MO45 1012	14,11
5/8"	1"1/16 16h UNF	MO45 1212	16,10

Hembra giratoria recta SAE

Straight swivel female SAE

Femelle tournante SAE droite



Femmina diritta SAE

DN	THREAD ROSCA	Part nº Referencia	€
5/16"	5/8" 18h UNF	FSR 0606	11,96
13/32"	3/4" 16h UNF	FSR 0808	13,04
1/2"	7/8" 14h UNF	FSR 1010	14,57

Codo 45° hembra giratoria SAE

45° Swivel female SAE

Femelle tournante 45° SAE



Femmina a 45° SAE

DN	THREAD ROSCA	Part nº Referencia	€
5/16"	5/8" 18h UNF	FS45 0606	12,88
13/32"	3/4" 16h UNF	FS45 0808	14,42
1/2"	7/8" 14h UNF	FS45 1010	15,34

Codo 90° hembra giratoria SAE

90° Swivel female SAE

Femelle tournante 90° SAE



Femmina a 90° SAE

DN	THREAD ROSCA	Part nº Referencia	€
5/16"	5/8" 18h UNF	FS90 0606	13,04
13/32"	3/4" 16h UNF	FS90 0808	14,42
1/2"	7/8" 14h UNF	FS90 1010	15,49

Racores aire acondicionado

Air conditioning fittings
Raccords climatisation
Raccordi aria condizionata

Hembra recta con junta Rotalock y válvula

Straight female with Rotalock joint and valve

Femelle droite Rotalock avec joint et vanne pour R12

Femmina diritta con guarnizione Rotalock e valvola



DN	THREAD ROSCA	Part n° Referencia	€
13/32"	1" 14h UNS	FXRV 1108	20,25
1/2"	1" 14h UNS	FXRV 1110	22,42

Hembra especial 90° con junta Rotalock y válvula

90° Special female with Rotalock joint and valve

Femelle spéciale 90° Rotalock avec joint et vanne pour R12

Femmina a 90° speciale con guarnizione Rotalock e valvola



DN	THREAD ROSCA	Part n° Referencia	€
13/32"	1" 14h UNS	FXAV90 1108	29,14
1/2"	1" 14h UNS	FXAV90 1110	29,45

Junta tórica para racores Freón 134

Joints for air conditioning 134 fittings

Joint torique spécial pour Freon 134

O'ring per raccordi per Freon 134



DN	Part n° Referencia	€
5/16"	7.65X1.78 FREON	0,72
13/32"	10.82X1.78 FREON	0,84
5/8"	14X1.78 FREON	1,05
5/8"	18.77X1.78 FREON	1,31

Racor de unión con válvula

Union fitting with valve

Raccord union avec vanne pour R14 splicer vanne pour R12

Raccordi de unione con valvola



DN	Part n° Referencia	€
5/16"	URTV 0006	17,79
13/32"	URTV 0008	18,25
1/2"	URTV 0010	18,87

Hembra 90° con junta Rotalock y válvula

90° Female with Rotalock joint and valve

Femelle 90° Rotalock avec joint et vanne pour R12

Femmina a 90° con guarnizione Rotalock e valvola



DN	THREAD ROSCA	Part n° Referencia	€
13/32"	1" 14h UNS	FX90V 1108	22,24
1/2"	1" 14h UNS	FX90V 1110	23,31

Racores recuperables cargadoras

Reusable fittings for loaders

Raccords climatisation récupérables pour chargeurs

Raccordi recuperabili per carico



DN	THREAD ROSCA	DESCRIPTION DESCRIPCIÓN	Part n° Referencia	€
3/16"	7/16"	90° Swivel female	CRFC900703	14,70
3/16"	7/16"	Ferrule	CRFM003	4,46
3/16"	7/16"	Swivel female	CRFTL0703	6,04

ATENCIÓN



UNA CORRECTA LUBRICACIÓN GARANTIZA EL BUEN FUNCIONAMIENTO DE LAS ROSCAS

NO LO OLVIDE



DO NOT FORGET IT

A CORRECT LUBRICATING GUARANTEES YOU A CORRECT USE OF THE THREADS



WARNING

Tubo rígado

Pipe connectors
Connectique rigide
Tubo rigido

TrAle®

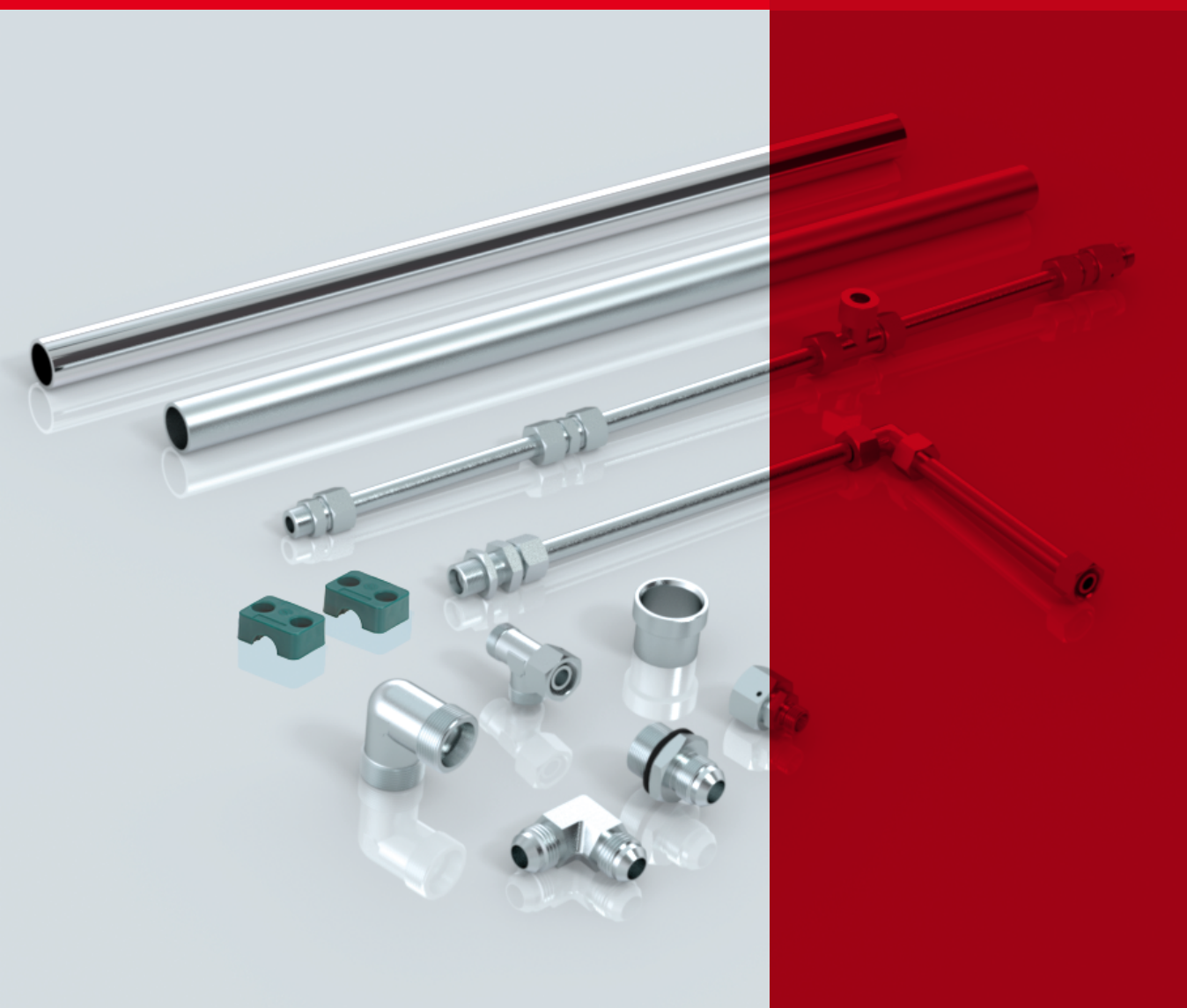

Tubo rígido TrΔle

TrΔle Pipe
Tube rigide TrΔle
Tubo rigido TrΔle

1

Racores DIN 2353 / Racores JIC 37°

Pipe Fittings DIN 2353 / Flare fittings JIC 37°
Raccords DIN 2353 / Adapteurs JIC 37°
Raccordi DIN 2353 / Raccordi JIC 37°

2

Bridas SAE

SAE Flanges
Brides de fixation SAE
Flangia SAE

3

Abrazaderas TrΔle

TrΔle Clamps
Colliers TrΔle
Collari fissatubo TrΔle

4

Máquinas para procesar el tubo rígido

Machines for processing rigid pipes
Machines pour travailler le tube rigide
Macchine per il trattamento del tubo rigido

5

Tubo rígido TrΔle

TrΔle Pipe

Tube rigide TrΔle

Tubo rigido TrΔle

Tubo rígido métrico TrΔle

Pipe EN 10305-4 (Metric) TrΔle

Tube rigide EN 10305-4 (Métrique) TrΔle

Tubo rigido EN 10305-4 (metrico) TrΔle

1

Tubo rígido métrico TrΔle

Pipe EN 10305-4 (Metric) TrΔle

Tube rigide EN 10305-4 (Métrique) TrΔle

Tubo rígido EN 10305-4 (metrico) TrΔle

- EN 10305-4 / Pipe EN 10305-4 (Metric) / Tube rigide EN 10305-4 (Métrique) / Tubo rígido EN 10305-4 (metrico)



TH0



THZ



TH0_3



THZ_3

TrAle[®]
DIN 2353



RACORES FABRICADOS POR
PIPE FITTINGS MANUFACTURED BY

DICSA

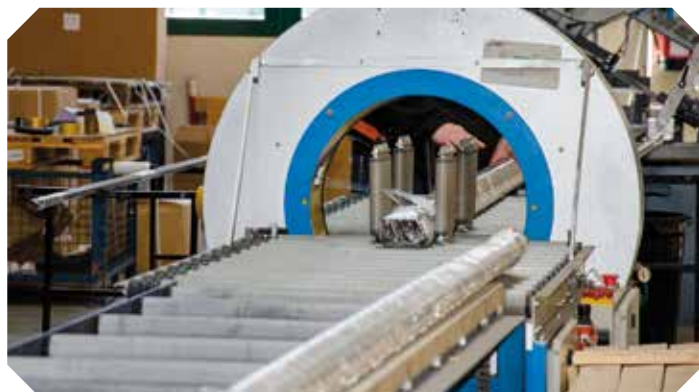

Tubo rígido métrico TrΔle

Pipe EN 10305-4 (Metric) TrΔle

Tube rigide EN 10305-4 (Métrique) TrΔle

Tubo rígido EN 10305-4 (metrico) TrΔle

Tubo rígido E235 (standard) - 6 mts

Pipe E235 (standard) - 6 mts

Tube rigide E235 (standard) - 6 mts

Tubo rígido E235 (standard) - 6 mts



Ø OUTER Ø EXT.	Ø INNER Ø INT.	WP (bar) PRESIÓN TRABAJO (bar)	KG/M	Part nº Referencia	€
6	4	365	0,123	TH0060100	4,45
8	6	259	0,173	TH0080100	5,01
8	5	423	0,240	TH0080150	5,38
10	7	321	0,314	TH0100150	5,94
12	9	259	0,388	TH0120150	6,62
14	10	303	0,592	TH0140200	9,65
15	12	201	0,499	TH0150150	7,85
16	12	259	0,690	TH0160200	10,51
18	14	226	0,789	TH0180200	10,88
20	14	321	1,258	TH0200300	16,75
22	18	181	0,986	TH0220200	13,66
25	19	247	1,628	TH0250300	20,65
28	24	139	1,282	TH0280200	18,05
30	24	201	1,997	TH0300300	24,61
35	29	169	2,367	TH0350300	29,74
42	36	139	2,885	TH0420300	36,23

Tubo rígido E235 (standard) - 3 mts

Pipe E235 (standard) - 3 mts

Tube rigide E235 (standard) - 3 mts

Tubo rígido E235 (standard) - 3 mts



Ø OUTER Ø EXT.	Ø INNER Ø INT.	WP (bar) PRESIÓN TRABAJO (bar)	KG/M	Part nº Referencia	€
6	4	365	0,123	TH0060100-3	4,67
8	6	259	0,172	TH0080100-3	5,26
8	5	423	0,24	TH0080150-3	5,65
10	7	321	0,314	TH0100150-3	6,23
12	9	259	0,388	TH0120150-3	6,95
14	10	303	0,591	TH0140200-3	10,13
15	12	201	0,499	TH0150150-3	8,24
16	12	259	0,69	TH0160200-3	11,04
18	14	226	0,789	TH0180200-3	11,43
20	14	321	1,257	TH0200300-3	17,59
22	18	181	0,986	TH0220200-3	14,35
25	19	247	1,627	TH0250300-3	21,68
28	24	139	1,282	TH0280200-3	18,96
30	24	201	1,997	TH0300300-3	25,84
35	29	169	2,367	TH0350300-3	31,22
42	36	139	2,885	TH0420300-3	38,04

Tubo rígido E235 (Cromo III) - 6 mts

Pipe E235 (Chrome III) - 6 mts

Tube rigide E235 (Chrome III) - 6 mts

Tubo rígido E235 (Cromo III) - 6 mts



Ø OUTER Ø EXT.	Ø INNER Ø INT.	WP (bar) PRESIÓN TRABAJO (bar)	KG/M	Part nº Referencia	€
6	4	365	0,123	THZ060100	5,13
8	6	259	0,173	THZ080100	5,94
8	5	423	0,240	THZ080150	6,18
10	7	321	0,314	THZ100150	7,23
12	9	259	0,388	THZ120150	7,91
12	8	365	0,500	THZ120200	9,95
14	10	303	0,592	THZ140200	11,13
15	12	201	0,499	THZ150150	9,58
15	11	279	0,641	THZ150200	12,86
16	12	259	0,690	THZ160200	12,24
18	15	164	0,610	THZ180150	11,19
18	14	226	0,789	THZ180200	12,92
20	14	321	1,258	THZ200300	18,92
22	18	189	0,986	THZ220200	16,07
25	19	247	1,628	THZ250300	23,93
28	24	139	1,282	THZ280200	21,70
30	22	279	2,565	THZ300400	36,60
35	29	169	2,367	THZ350300	34,44
38	30	213	3,354	THZ380400	47,79
42	36	139	2,885	THZ420300	42,29

Tubo rígido E235 (Cromo III) - 3 mts

Pipe E235 (Chrome III) - 3 mts

Tube rigide E235 (Chrome III) - 3 mts

Tubo rígido E235 (Cromo III) - 3 mts



Ø OUTER Ø EXT.	Ø INNER Ø INT.	WP (bar) PRESIÓN TRABAJO (bar)	KG/M	Part nº Referencia	€
6	4	365	0,123	THZ060100-3	5,39
8	6	259	0,172	THZ080100-3	6,23
8	5	423	0,240	THZ080150-3	6,49
10	7	321	0,314	THZ100150-3	7,60
12	9	259	0,388	THZ120150-3	8,31
12	8	365	0,500	THZ120200-3	10,45
14	10	303	0,591	THZ140200-3	11,68
15	12	201	0,499	THZ150150-3	10,06
15	11	279	0,641	THZ150200-3	13,50
16	12	259	0,690	THZ160200-3	12,85
18	15	164	0,610	THZ180150-3	11,75
18	14	226	0,789	THZ180200-3	13,57
20	14	321	1,257	THZ200300-3	19,87
22	18	189	0,986	THZ220200-3	16,88
25	19	247	1,627	THZ250300-3	25,12
28	24	139	1,282	THZ280200-3	22,79
30	22	279	2,564	THZ300400-3	38,43
35	29	169	2,367	THZ350300-3	36,16
38	30	213	3,354	THZ380400-3	50,18
42	36	139	2,885	THZ420300-3	44,40

ACERO INOXIDABLE

SCHEDULE

TUBO + RACOR

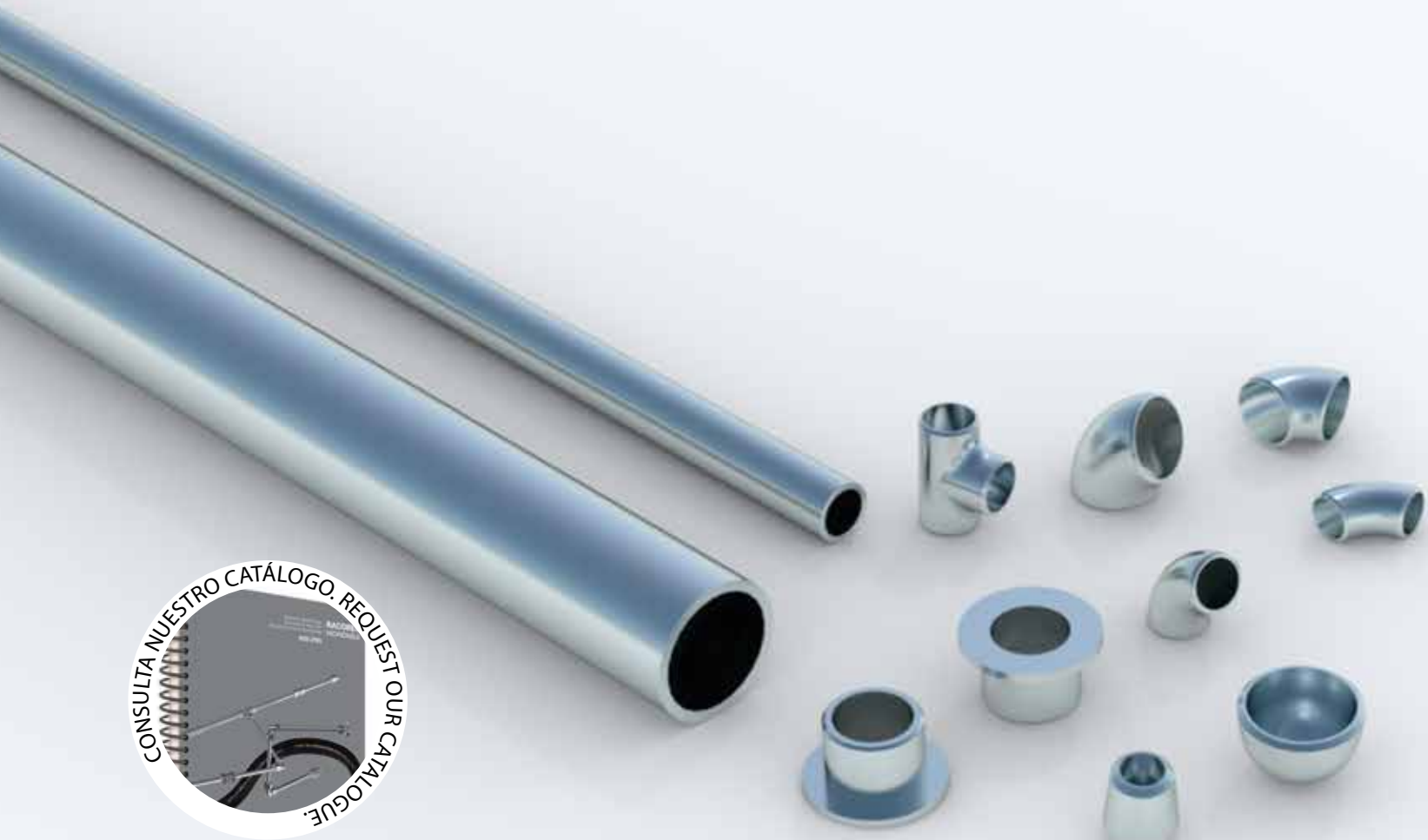

PIPE + FITTINGS

SCHEDULE

STAINLESS STEEL

Racores DIN 2353 / Racores JIC 37°

Pipe Fittings DIN 2353 / Flare fittings JIC 37°

Raccords DIN 2353 / Adapteurs JIC 37°

Raccordi DIN 2353 / Raccordi JIC 37°

Racores DIN 2353

DIN 2353 Pipe fittings

Raccords à bague DIN 2353

Raccordi ad anello DIN 2353

214

Racores JIC 37°

JIC 37° fittings

Raccords JIC 37°

Raccordi JIC 37°

233

2

Racores DIN 2353

DIN 2353 Pipe fittings

Raccords à bague DIN 2353

Raccordi ad anello DIN 2353

- Tuercas y anillos / Nuts and cutting rings / Écrou et bagues / Dadi e anelli | 214

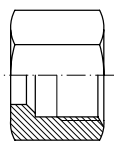

ML/MS



ACL/ACS

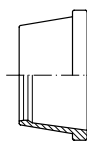

VA



ACIL/ACIS

- Uniones tubo-tubo / Straight couplings / Unions doubles / Raccordi intermedi | 216

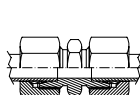

DL/DS

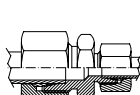

DL/DS

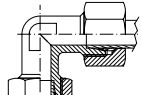

EL/ES

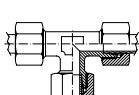

TL/TS

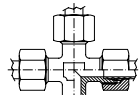

KVL/KVS

- Uniones rectas tubo-rosca / Straight male stud couplings / Unions simples mâle / Raccordi di estremità diritti | 218

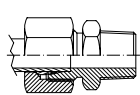

AKL/AKS BSPT

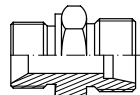

AL RC

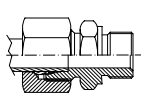

AL/AS BSP

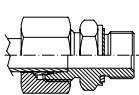

AL/AS WD BSP

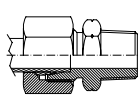

AKL/AKS NPT

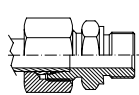

AL/AS UNF

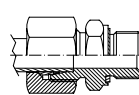

AL/AS WD METRICA

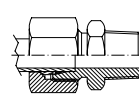

AKLL METRICA

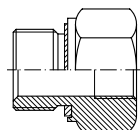

RI-R WD

- Codos tubo-rosca / Male stud elbows / Coudes mâle gaz / Raccordi di estremità a 90° | 222

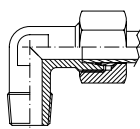

CKL/CKS BSPT

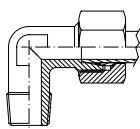

CKL/CKS METRICA

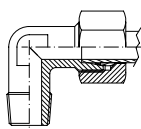

CKL/CKS NPT

- Uniones Métricas / Metric unions / Unions Métriques / Raccordi di riduzione (Metrici) | 223

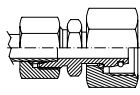

KORL-TLM

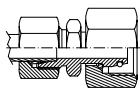

KORS-TLM

- Racores regulables / Adjustable stud couplings / Raccords réglables / Raccordi orientabili | 223

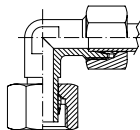

EEL/EES-CTA

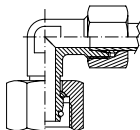

EEL/EES-TLM

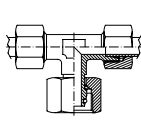

TEL/TES-TLM

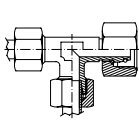

LEL/LES-TLM

- Tubo roscado (hembra giratoria) / Adjustable straight stud / Tube fileté / Raccordi di estremità per combinazioni | 225

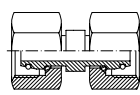

ATL/ATS

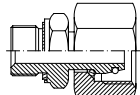

RAL/RAS-TLM METRICA

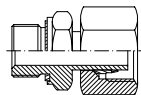

RAL/RAS-CTA METRICA

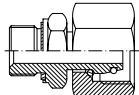

RAL/RAS-TLM BSP

Racores DIN 2353

DIN 2353 Pipe fittings
Raccords à bague DIN 2353
Raccordi ad anello DIN 2353

- Soldables /Welding couplings /Raccords à souder /Raccordi a saldare

| 226

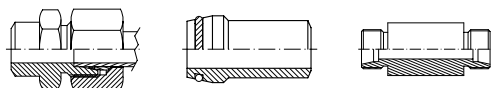

ASL/ASS

ORIS

ESVL/ESVS

- Pasatabiques /Bulkhead /Passe cloison /Raccordi di attraversamento

| 227

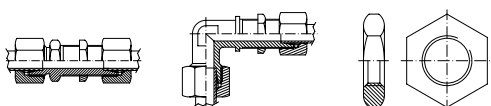

SVL/SVS

USVL/USVS

TP L/S

- Racor recto hembra /Straight female coupling /Raccord droit femelle /Raccordi diritti con estremità femmina

| 228

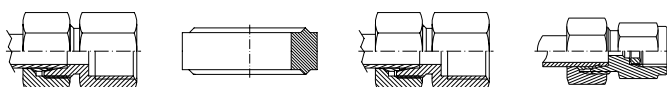

GAIL/GAIS BSP

AM

GAIL/GAIS METRICA

MAVL/MAVS BSP

- Orientables /Banjos /Banjos /Raccordi orientabili a occhio

| 229

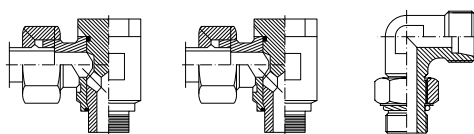

WSVL/WSVS BSP

WSVL/WSVS METRICA

STA WEE

- Taponos /Plugs /Bouchons /Tappi

| 230

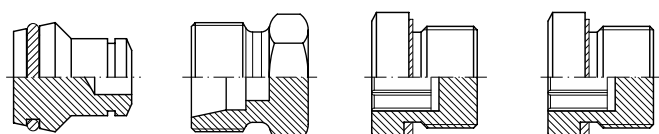

BUTZEN L/S

STA TML/TMS

STOPFEN BSP

STOPFEN METRICA

- Válvulas antirretorno /Non-return valves /Clapet antiretour pour tube /Valvole di ritegno

| 231

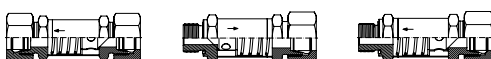

RHD/L/RHDS

RHV/L/RHVS

RHZ/L/RHZS

Racores JIC 37°

JIC 37° fittings

Raccordi JIC 37°

Raccordi JIC 37°

- Tuercas y férulas JIC 37° / Nuts and Sleeves / Écrous et Férules JIC 37° / Dadi e Bussole JIC 37°

| 233

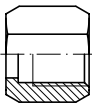

S110

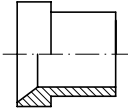

S120

- Tapones JIC 37° / JIC 37° Plugs / Bouchons JIC 37° / Tappi JIC 37°

| 233

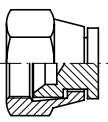

S130

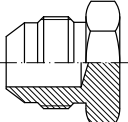

S140

- Uniones rectas JIC 37° / JIC 37° Straight union / Unions droites JIC 37° / Adattatori diritti JIC 37°

| 233

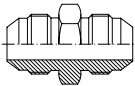

S260

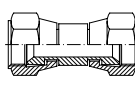

S730

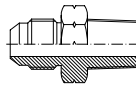

S200

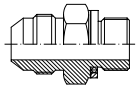

S230

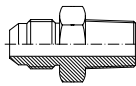

S210

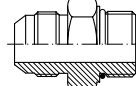

S220

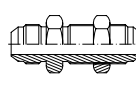

S250

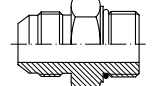

S240

- Uniones macho-hembra JIC 37° / JIC 37° Male-female unions / Unions mâle JIC 37° x femelle JIC 37° / Adattatori maschio-femmina JIC 37°

| 235

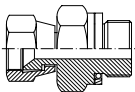

S180

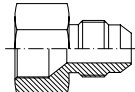

S290

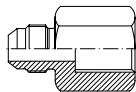

S280

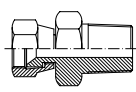

S150



S215

- Codos JIC 37° / JIC 37° Elbows / Coudes JIC 37° / Adattatori a 45° e 90° JIC 37°

| 236

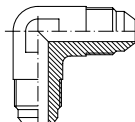

S500

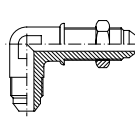

S650

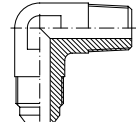

S550

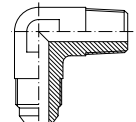

S525

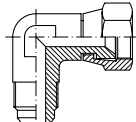

S675

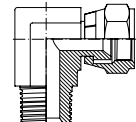

S595

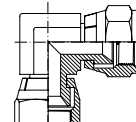

S665

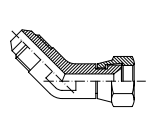

S690

- Codos Orientables JIC 37° / JIC 37° Elbow / Adapteur orientable coude JIC 37° / Raccordo orientabile

| 238

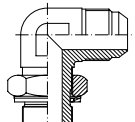

S600

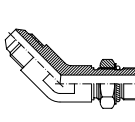

S615

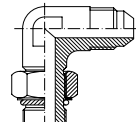

S575

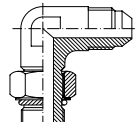

S625

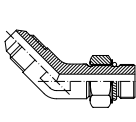

S775

- Tes JIC 37° / JIC 37° Tees / Tés JIC 37° / Adattatori a T JIC 37°

| 239

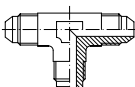

S505

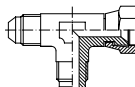

S680

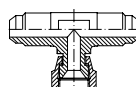

S685

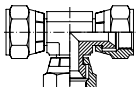

S670

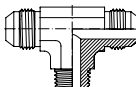

S681

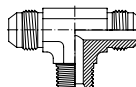

S695

- Tes orientable JIC 37° / JIC 37° Adjustable Tees / Tés orientables JIC 37° / Adattatori a T orientabili

| 240

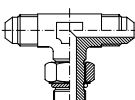

S610

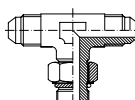

S585

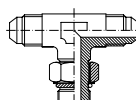

S635

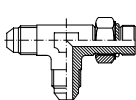

S605

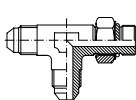

S580

Racores DIN 2353

DIN 2353 Pipe fittings
Raccords à bague DIN 2353
Raccordi DIN 2353

Tr/Ale Pipe

Pipe Fittings DIN 2353
/ Flare fittings JIC 37°

SAE Flanges

Tr/Ale Clamps

Machines for
processing rigid pipes

Instrucciones de montaje del racor DIN 2353 sobre el tubo rígido (se recomienda el uso de herramientas de premontaje)

Assembly of the pipe fittings DIN 2353 in the rigid pipe (It is recommended to use pre-assembly tools)

Mode d'emploi de montage du raccord DIN 2353 sur le tube rigide (l'utilisation des outils de pré-montage est conseillée)

Assemblaggio del raccordo ad anello DIN 2353 nel tubo rigido (è si consiglia l'uso degli utensili di premontaggio)

A. Preparación del tubo

Preparation of the tube

Préparation du tube

Preparazione del tubo

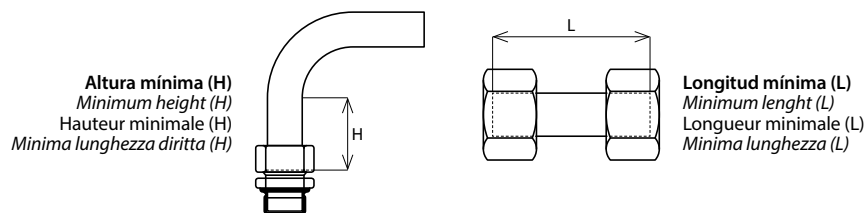

Altura mínima (H)
Minimum height (H)
Hauteur minimale (H)
Minima lunghezza diritta (H)

Longitud mínima (L)
Minimum length (L)
Longueur minimale (L)
Minima lunghezza (L)

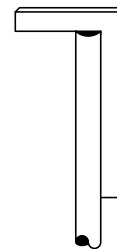

Cortar el tubo a escuadra y eliminar rebabas.

Rectangularly saw off the pipe and slightly deburr the tube ends inside and outside.

Couper le tube à angle droit sans bavure. Tagliare il tubo ad angolo retto ed eliminare i residui metallici.

	Series / Series / Série / Serie		
	LL	L	S
Ø exterior Ø outer Ø extérieur Ø esterno	4-5-6-8	6-8-10-12-15-18-22-28-35-42	6-8-10-12-14-16-20-25-30-38
H mínimo H minimum H minimum H minimo	24-25-25-26	31-31-33-33-36-38-42-42-48-48	35-35-37-37-43-43-50-54-58-65
L mínimo L minimum L minimum L minimo	30-32-32-33	39-39-42-42-45-48-53-53-60-60	44-44-47-47-54-54-63-68-73-82

B. Lubricar adecuadamente

Lubricate suitably

Lubrifier convenablement

Lubrificare convenientemente

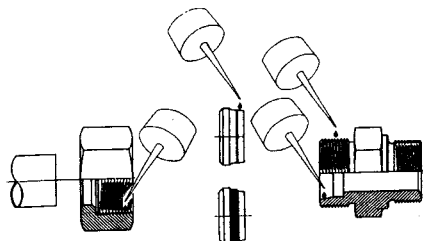

C. Montaje

Assembly

Montage

Montaggio



D. Apriete

Blocking

Blockage

Bloccaggio

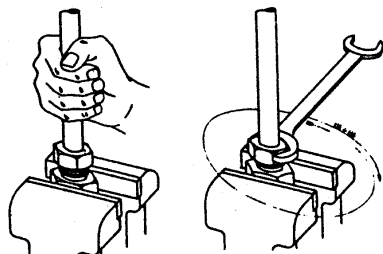

E. Control

Control

Control

Controllo

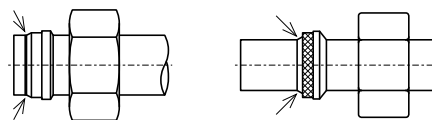

F. Montaje final

Final assembly

Montage final

Montaggio finale

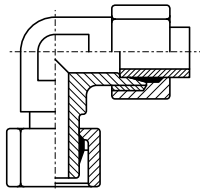

G. Montajes posteriores

Later assemblies

Montages posterieurs

Montaggio successivo

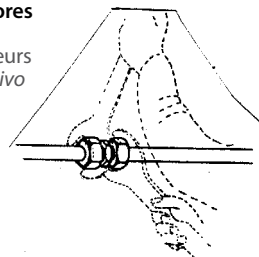

Nota sobre piezas premontadas (CTA): El montaje final se realizará apretando la tuerca al menos ½ vuelta más desde el punto a partir del cual se empieza a hacer más fuerza.

For preassembled fittings (CTA), the final assembly is made tightening the nut at least ½ turn beyond the point of a noticeable increase in force.

Pour les pièces pré-assemblées (CTA), le montage final doit être fait en tournant au moins un ½ tour à partir du point où une résistance plus importante est appréciée.

Per tutti i raccordi premontati (CTA), il premontaggio avviene con apposite attrezzature. Il montaggio finale si realizza serrando almeno ½ giro oltre il punto in cui si inizia ad avvertire chiaramente l'aumento della resistenza.

Racores DIN 2353

DIN 2353 Pipe fittings

Raccords à bague DIN 2353

Raccordi ad anello DIN 2353

Tuerca Métrica DIN 3870

Nuts DIN 3870

Écrou Métrique DIN 3870

Dadi Metrici DIN 3870

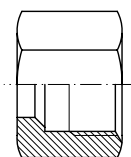

PIPE TUBO	SERIE	THREAD ROSCA	Part nº Referencia	€
4	LL	M8x1	MLL 4 M 8X1	0,35
6	LL	M10x1	MLL 6 M 10X1	0,35
8	LL	M12x1	MLL 8 M 12X1	0,41
6	L	M12x1,5	ML 6 M 12X1.5	0,35
8	L	M14x1,5	ML 8 M 14X1.5	0,32
10	L	M16x1,5	ML 10 M 16X1.5	0,38
12	L	M18x1,5	ML 12 M 18X1.5	0,47
15	L	M22x1,5	ML 15 M 22X1.5	0,74
18	L	M26x1,5	ML 18 M 26X1.5	1,15
22	L	M30x2	ML 22 M 30X2	1,62
28	L	M36x2	ML 28 M 36X2	2,67
35	L	M45x2	ML 35 M 45X2	4,63
42	L	M52x2	ML 42 M 52X2	6,36
6	S	M14x1,5	MS 6 M 14X1.5	0,39
8	S	M16x1,5	MS 8 M 16X1.5	0,43
10	S	M18x1,5	MS 10 M 18X1.5	0,55
12	S	M20x1,5	MS 12 M 20X1.5	0,59
14	S	M22x1,5	MS 14 M 22X1.5	1,12
16	S	M24x1,5	MS 16 M 24X1.5	1,16
20	S	M30x2	MS 20 M 30X2	1,82
25	S	M36x2	MS 25 M 36X2	3,78
30	S	M42x2	MS 30 M 42X2	5,78
38	S	M52x2	MS 38 M 52X2	7,61

Anillos de corte DIN 3861

Cutting rings DIN 3861

Bague Métrique DIN 3861

Anelli DIN 3861



PIPE TUBO	SERIE	Part nº Referencia	€
4	LL	ACLL 4	0,23
6	LL	ACLL 6	0,24
8	LL	ACLL 8	0,29
6	L/S	ACL 6	0,31
8	L/S	ACL 8	0,32
10	L/S	ACL 10	0,44
12	L/S	ACL 12	0,46
15	L	ACL 15	0,49
18	L	ACL 18	0,70
22	L	ACL 22	0,79
28	L	ACL 28	1,01
35	L	ACL 35	1,08
42	L	ACL 42	2,03
14	S	ACS 14	0,60
16	S	ACS 16	0,70
20	S	ACS 20	0,79
25	S	ACS 25	1,01
30	S	ACS 30	1,23
38	S	ACS 38	1,59

Anillo FKM antifuga

FKM seal non-leak

Joint FKM anti-fouet

Anello FKM anti-trafilamento

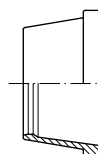

PIPE TUBO	SERIE	Part nº Referencia	€
6	L/S	VA006L	1,33
8	L/S	VA008L	1,41
10	L/S	VA010L	1,46
12	L/S	VA012L	1,58
15	L	VA015L	2,07
18	L	VA018L	2,13
22	L	VA022L	2,39
28	L	VA028L	3,29
35	L	VA035L	5,20
42	L	VA042L	6,25
14	S	VA014S	1,72
16	S	VA016S	2,09
20	S	VA020S	2,30
25	S	VA025S	3,12
30	S	VA030S	4,77
38	S	VA038S	6,15

Hasta fin de existencias / Until end of stock / Jusqu'à la fin du stock / Fino ad esaurimento scorta

Racores DIN 2353

DIN 2353 Pipe fittings
Raccords à bague DIN 2353
Raccordi ad anello DIN 2353

Anillos de corte con junta plana + tórica

Cutting ring with captive seal & o'ring

Bague Métrique avec écrou + o'ring

Anelli tagliante con guarnizione piana + O-ring



PIPE TUBO	SERIE	Part nº Referencia	€
6	L	ACJL 6	1,06
8	L	ACJL 8	1,16
10	L	ACJL 10	1,23
12	L	ACJL 12	1,37
15	L	ACJL 15	1,64
18	L	ACJL 18	2,11
22	L	ACJL 22	2,55
28	L	ACJL 28	3,46
35	L	ACJL 35	5,66
42	L	ACJL 42	6,52
6	S	ACJS 6	1,06
8	S	ACJS 8	1,26
10	S	ACJS 10	1,26
12	S	ACJS 12	1,49
14	S	ACJS 14	1,59
16	S	ACJS 16	1,93
20	S	ACJS 20	2,68
25	S	ACJS 25	3,55
30	S	ACJS 30	4,81
38	S	ACJS 38	6,87

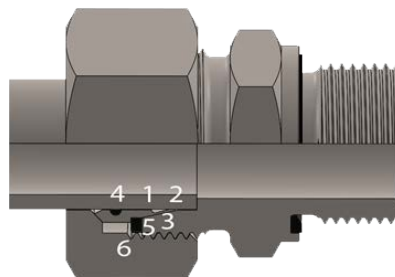

- Asegura una completa estanqueidad con el anillo de corte con junta
- To ensure the right tightening with our cutting ring with joint

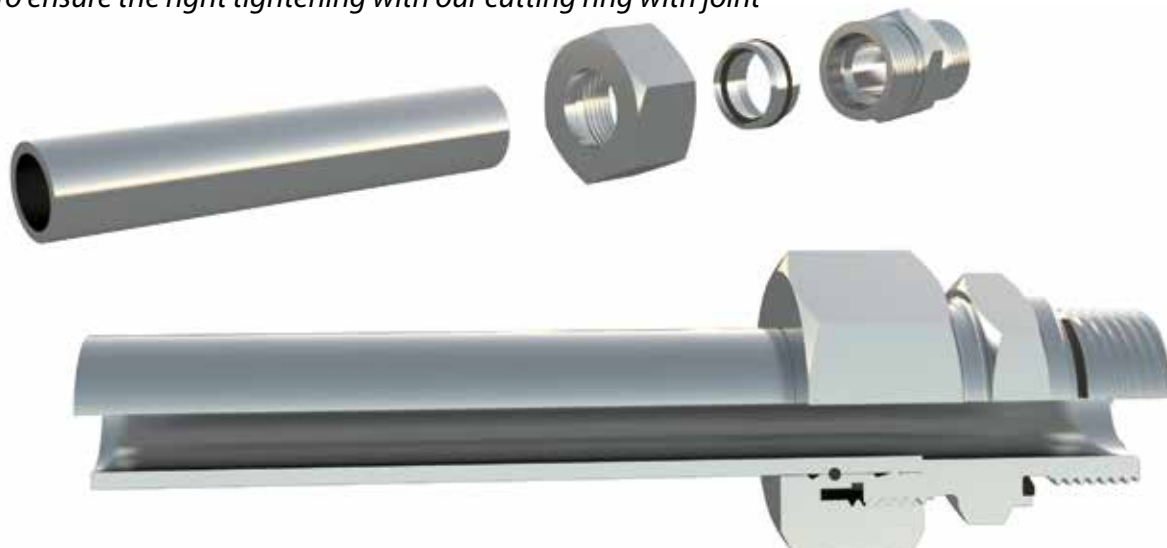

Consulta en nuestra ficha técnica datos | Check our technical sheet for data

Racores DIN 2353

DIN 2353 Pipe fittings
Raccords à bague DIN 2353
Raccordi ad anello DIN 2353

Unión recta tubo-tubo

Straight coupling (pipe-pipe)

Union droite (tuyau-tuyau)

Raccordo intermedio diritto (tubo-tubo)

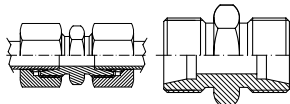

PIPE TUBO	SERIE	Part nº Referencia	€	Part Nº STA Referencia STA	€
4	LL	DLL 4	2,76	STA DLL 4	1,08
6	LL	DLL 6	2,75	STA DLL 6	1,05
8	LL	DLL 8	2,97	STA DLL 8	1,05
6	L	DL 6	2,67	STA DL 6	0,83
8	L	DL 8	2,75	STA DL 8	0,95
10	L	DL 10	3,18	STA DL 10	1,02
12	L	DL 12	3,41	STA DL 12	1,03
15	L	DL 15	4,83	STA DL 15	1,69
18	L	DL 18	6,35	STA DL 18	1,97
22	L	DL 22	8,96	STA DL 22	3,10
28	L	DL 28	13,62	STA DL 28	5,22
35	L	DL 35	20,78	STA DL 35	7,80
42	L	DL 42	31,32	STA DL 42	12,98
6	S	DS 6	2,93	STA DS 6	1,01
8	S	DS 8	3,36	STA DS 8	1,34
10	S	DS 10	4,13	STA DS 10	1,63
12	S	DS 12	4,40	STA DS 12	1,78
14	S	DS 14	6,28	STA DS 14	2,16
16	S	DS 16	6,63	STA DS 16	2,23
20	S	DS 20	10,21	STA DS 20	3,95
25	S	DS 25	17,10	STA DS 25	6,48
30	S	DS 30	24,98	STA DS 30	9,40
38	S	DS 38	35,20	STA DS 38	15,24

Unión recta en reducción tubo-tubo

Straight reducing coupling (pipe-pipe)

Union double en réduction (tuyau-tuyau)

Raccordo intermedio di riduzione (tubo-tubo)

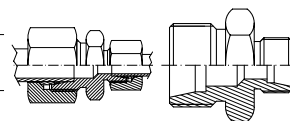

PIPE TUBO	SERIE	Part nº Referencia	€	Part Nº STA Referencia STA	€	
8	6	L	DL 8-6	3,01	STA DL 8-6	1,19
10	6	L	DL 10-6	3,24	STA DL 10-6	1,24
10	8	L	DL 10-8	3,32	STA DL 10-8	1,34
12	8	L	DL 12-8	3,43	STA DL 12-8	1,34
12	10	L	DL 12-10	3,64	STA DL 12-10	1,37
15	10	L	DL 15-10	4,72	STA DL 15-10	2,07
15	12	L	DL 15-12	4,81	STA DL 15-12	2,05
18	12	L	DL 18-12	5,79	STA DL 18-12	2,41
18	15	L	DL 18-15	6,05	STA DL 18-15	2,29
22	15	L	DL 22-15	8,52	STA DL 22-15	4,02
22	18	L	DL 22-18	8,67	STA DL 22-18	3,55
28	22	L	DL 28-22	12,87	STA DL 28-22	5,74
35	22	L	DL 35-22	31,43	STA DL 35-22	22,01
35	28	L	DL 35-28	32,70	STA DL 35-28	22,01
8	6	S	DS 8-6	3,50	STA DS 8-6	1,53
10	6	S	DS 10-6	3,69	STA DS 10-6	1,48
10	8	S	DS 10-8	3,86	STA DS 10-8	1,60
12	6	S	DS 12-6	4,44	STA DS 12-6	2,17
12	8	S	DS 12-8	4,91	STA DS 12-8	2,59
12	10	S	DS 12-10	5,15	STA DS 12-10	2,59
14	10	S	DS 14-10	5,70	STA DS 14-10	2,39
14	12	S	DS 14-12	5,68	STA DS 14-12	2,31
16	12	S	DS 16-12	6,16	STA DS 16-12	2,65
16	14	S	DS 16-14	7,02	STA DS 16-14	2,76
20	12	S	DS 20-12	9,05	STA DS 20-12	4,61
20	16	S	DS 20-16	9,69	STA DS 20-16	4,36
25	16	S	DS 25-16	14,33	STA DS 25-16	6,82
25	20	S	DS 25-20	16,47	STA DS 25-20	8,03
30	20	S	DS 30-20	34,96	STA DS 30-20	24,04
30	25	S	DS 30-25	37,53	STA DS 30-25	24,43
38	30	S	DS 38-30	52,22	STA DS 38-30	34,45

Racores DIN 2353

DIN 2353 Pipe fittings
Raccords à bague DIN 2353
Raccordi ad anello DIN 2353

Tr/Ale pipe

Pipe fittings DIN 2353
/ Flare fittings JIC 37°

SAE Flanges

Tr/Ale Clamps

Machines for
processing rigid pipes

Unión en codo tubo-tubo

Equal elbow coupling (pipe-pipe)

Union en coude égal (tuyau-tuyau)

Raccordo intermedio a 90° (tubo-tubo)

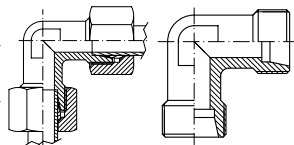

PIPE TUBO	SERIE	Part nº Referencia	€	Part Nº STA Referencia STA	€
4	LL	ELL 4	3,90	STA ELL 4	2,22
6	LL	ELL 6	3,92	STA ELL 6	2,22
8	LL	ELL 8	4,48	STA ELL 8	2,56
6	L	EL 6	4,81	STA EL 6	2,97
8	L	EL 8	4,70	STA EL 8	2,90
10	L	EL 10	5,06	STA EL 10	2,90
12	L	EL 12	5,62	STA EL 12	3,24
15	L	EL 15	8,00	STA EL 15	4,86
18	L	EL 18	10,65	STA EL 18	6,27
22	L	EL 22	13,58	STA EL 22	7,72
28	L	EL 28	22,46	STA EL 28	14,06
35	L	EL 35	37,97	STA EL 35	24,99
42	L	EL 42	48,81	STA EL 42	30,47
6	S	ES 6	5,38	STA ES 6	3,46
8	S	ES 8	5,62	STA ES 8	3,60
10	S	ES 10	7,10	STA ES 10	4,60
12	S	ES 12	6,56	STA ES 12	3,94
14	S	ES 14	9,91	STA ES 14	5,79
16	S	ES 16	10,13	STA ES 16	5,73
20	S	ES 20	13,98	STA ES 20	7,72
25	S	ES 25	21,63	STA ES 25	11,01
30	S	ES 30	42,33	STA ES 30	26,75
38	S	ES 38	48,41	STA ES 38	28,45

Unión en te tubo-tubo

Equal Tee union (pipe-pipe-pipe)

Union en Té égal (tuyau-tuyau)

Raccordo intermedio a T (tubo-tubo)

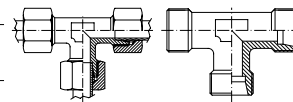

PIPE TUBO	SERIE	Part nº Referencia	€	Part Nº STA Referencia STA	€
4	LL	TLL 4	5,88	STA TLL 4	3,36
6	LL	TLL 6	5,30	STA TLL 6	2,75
8	LL	TLL 8	6,20	STA TLL 8	3,32
6	L	TL 6	6,18	STA TL 6	3,42
8	L	TL 8	6,56	STA TL 8	3,86
10	L	TL 10	7,09	STA TL 10	3,85
12	L	TL 12	8,02	STA TL 12	4,45
15	L	TL 15	10,08	STA TL 15	5,37
18	L	TL 18	15,96	STA TL 18	9,39
22	L	TL 22	21,12	STA TL 22	12,33
28	L	TL 28	34,15	STA TL 28	21,55
35	L	TL 35	63,79	STA TL 35	44,32
42	L	TL 42	91,70	STA TL 42	64,19
6	S	TS 6	6,48	STA TS 6	3,60
8	S	TS 8	8,75	STA TS 8	5,72
10	S	TS 10	9,49	STA TS 10	5,74
12	S	TS 12	10,49	STA TS 12	6,56
14	S	TS 14	13,16	STA TS 14	6,98
16	S	TS 16	15,18	STA TS 16	8,58
20	S	TS 20	20,41	STA TS 20	11,02
25	S	TS 25	37,04	STA TS 25	21,11
30	S	TS 30	48,94	STA TS 30	25,57
38	S	TS 38	72,96	STA TS 38	43,02

Unión en cruz tubo-tubo

Equal cross union (pipe-pipe-pipe-pipe)

Union en croix égale (tuyau-tuyau)

Raccordo intermedio a croce (tubo-tubo)

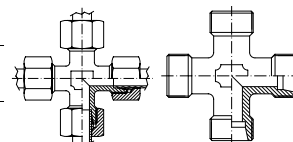

PIPE TUBO	SERIE	Part nº Referencia	€	Part Nº STA Referencia STA	€
6	L	KVL 6	*	STA KVL 6	8,41
8	L	KVL 8	*	STA KVL 8	10,45
10	L	KVL 10	*	STA KVL 10	10,45
12	L	KVL 12	*	STA KVL 12	10,62
15	L	KVL 15	*	STA KVL 15	15,00
18	L	KVL 18	*	STA KVL 18	21,34
22	L	KVL 22	*	STA KVL 22	44,90
28	L	KVL 28	*	STA KVL 28	52,51
35	L	KVL 35	*	STA KVL 35	88,55
42	L	KVL 42	*	STA KVL 42	141,59
6	S	KVS 6	*	STA KVS 6	15,59
8	S	KVS 8	*	STA KVS 8	16,38
10	S	KVS 10	*	STA KVS 10	16,74
12	S	KVS 12	*	STA KVS 12	17,83
14	S	KVS 14	*	STA KVS 14	27,27
16	S	KVS 16	*	STA KVS 16	27,37
20	S	KVS 20	*	STA KVS 20	46,58
25	S	KVS 25	*	STA KVS 25	52,95
30	S	KVS 30	*	STA KVS 30	103,25
38	S	KVS 38	*	STA KVS 38	141,59

Racores DIN 2353

DIN 2353 Pipe fittings
Raccords à bague DIN 2353
Raccordi ad anello DIN 2353

Racor recto rosca cónica BSPT

Straight male stud coupling BSPT tapered

Union simple mâle conique

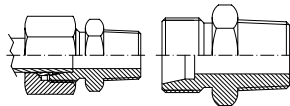

Raccordo di estremità diritto conico BSPT

PIPE TUBO	SERIE	THREAD ROSCA	Part nº Referencia	€	Part Nº STA Referencia STA	€
4	LL	1/8" BSPT	AKLL 4 R 1/8	1,69	STA AKLL 4 R 1/8	0,85
6	LL	1/8" BSPT	AKLL 6 R 1/8	1,70	STA AKLL 6 R 1/8	0,85
8	LL	1/8" BSPT	AKLL 8 R 1/8	1,83	STA AKLL 8 R 1/8	0,87
8	LL	1/4" BSPT	AKLL 8 R 1/4	1,93	STA AKLL 8 R 1/4	0,97
6	L	1/8" BSPT	AKL 6 R 1/8	1,81	STA AKL 6 R 1/8	0,89
6	L	1/4" BSPT	AKL 6 R 1/4	2,17	STA AKL 6 R 1/4	1,25
8	L	1/4" BSPT	AKL 8 R 1/4	2,12	STA AKL 8 R 1/4	1,22
10	L	1/4" BSPT	AKL 10 R 1/4	2,29	STA AKL 10 R 1/4	1,21
10	L	3/8" BSPT	AKL 10 R 3/8	2,57	STA AKL 10 R 3/8	1,49
12	L	1/4" BSPT	AKL 12 R 1/4	2,71	STA AKL 12 R 1/4	1,52
12	L	3/8" BSPT	AKL 12 R 3/8	2,69	STA AKL 12 R 3/8	1,50
12	L	1/2" BSPT	AKL 12 R 1/2	3,19	STA AKL 12 R 1/2	2,00
15	L	3/8" BSPT	AKL 15 R 3/8	3,15	STA AKL 15 R 3/8	1,58
15	L	1/2" BSPT	AKL 15 R 1/2	3,63	STA AKL 15 R 1/2	2,06
18	L	1/2" BSPT	AKL 18 R 1/2	4,83	STA AKL 18 R 1/2	2,64
22	L	3/4" BSPT	AKL 22 R 3/4	6,43	STA AKL 22 R 3/4	3,50
6	S	1/4" BSPT	AKS 6 R 1/4	2,30	STA AKS 6 R 1/4	1,34
8	S	1/4" BSPT	AKS 8 R 1/4	2,53	STA AKS 8 R 1/4	1,52
10	S	3/8" BSPT	AKS 10 R 3/8	2,78	STA AKS 10 R 3/8	1,53
12	S	3/8" BSPT	AKS 12 R 3/8	3,26	STA AKS 12 R 3/8	1,95
16	S	1/2" BSPT	AKS 16 R 1/2	5,18	STA AKS 16 R 1/2	2,98
20	S	3/4" BSPT	AKS 20 R 3/4	8,67	STA AKS 20 R 3/4	5,54

Racor recto rosca cilíndrica BSP 60°

Straight male stud coupling BSP cyl. 60°

Union simple mâle gaz cylindrique 60°

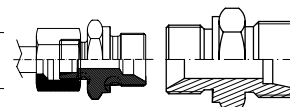

Raccordo di estremità diritto BSP 60°

T.	S.	THREAD ROSCA	Part nº Referencia	€	Part Nº STA Referencia STA	€
6	L	1/8" BSP	AL 6 RC 1/8	1,91	STA AL 6 RC 1/8	0,99
6	L	1/4" BSP	AL 6 RC 1/4	2,15	STA AL 6 RC 1/4	1,23
6	L	1/2" BSP	AL 6 RC 1/2	2,78	STA AL 6 RC 1/2	1,86
6	L	3/8" BSP	AL 6 RC 3/8	2,55	STA AL 6 RC 3/8	1,63
10	L	1/2" BSP	AL 8 RC 1/8	2,03	STA AL 8 RC 1/8	1,13
8	L	1/4" BSP	AL 8 RC 1/4	2,20	STA AL 8 RC 1/4	1,30
8	L	3/8" BSP	AL 8 RC 3/8	2,63	STA AL 8 RC 3/8	1,73
8	L	1/2" BSP	AL 8 RC 1/2	3,66	STA AL 8 RC 1/2	2,76
10	L	1/8" BSP	AL 10 RC 1/8	2,65	STA AL 10 RC 1/8	1,57
10	L	1/4" BSP	AL 10 RC 1/4	2,30	STA AL 10 RC 1/4	1,22
10	L	3/8" BSP	AL 10 RC 3/8	2,69	STA AL 10 RC 3/8	1,61
10	L	1/2" BSP	AL 10 RC 1/2	3,18	STA AL 10 RC 1/2	2,10
12	L	1/4" BSP	AL 12 RC 1/4	2,70	STA AL 12 RC 1/4	1,51
12	L	3/8" BSP	AL 12 RC 3/8	2,43	STA AL 12 RC 3/8	1,24
12	L	1/2" BSP	AL 12 RC 1/2	3,26	STA AL 12 RC 1/2	2,07
12	L	3/4" BSP	AL 12 RC 3/4	3,95	STA AL 12 RC 3/4	2,76
15	L	3/8" BSP	AL 15 RC 3/8	3,30	STA AL 15 RC 3/8	1,73
15	L	1/2" BSP	AL 15 RC 1/2	3,64	STA AL 15 RC 1/2	2,07
15	L	3/4" BSP	AL 15 RC 3/4	4,24	STA AL 15 RC 3/4	2,67
18	L	3/8" BSP	AL 18 RC 3/8	4,05	STA AL 18 RC 3/8	1,86
18	L	1/2" BSP	AL 18 RC 1/2	4,35	STA AL 18 RC 1/2	2,16
18	L	3/4" BSP	AL 18 RC 3/4	6,04	STA AL 18 RC 3/4	3,85
22	L	1/2" BSP	AL 22 RC 1/2	6,37	STA AL 22 RC 1/2	3,44
22	L	3/4" BSP	AL 22 RC 3/4	6,19	STA AL 22 RC 3/4	3,26
22	L	1" BSP	AL 22 RC 1	10,27	STA AL 22 RC 1	7,34
28	L	3/4" BSP	AL 28 RC 3/4	11,18	STA AL 28 RC 3/4	6,98
28	L	1" BSP	AL 28 RC 1	10,51	STA AL 28 RC 1	6,31
35	L	1" BSP	AL 35 RC 1	17,23	STA AL 35 RC 1	10,74
35	L	1" 1/4 BSP	AL 35 RC 1 1/4	16,82	STA AL 35 RC 1 1/4	10,33
42	L	1" 1/2 BSP	AL 42 RC 1 1/2	23,65	STA AL 42 RC 1 1/2	14,48
6	S	1/4" BSP	AS 6 RC 1/4	2,48	STA AS 6 RC 1/4	1,52
8	S	1/4" BSP	AS 8 RC 1/4	2,45	STA AS 8 RC 1/4	1,44
8	S	3/8" BSP	AS 8 RC 3/8	2,94	STA AS 8 RC 3/8	1,93
10	S	1/4" BSP	AS 10 RC 1/4	2,91	STA AS 10 RC 1/4	1,66
10	S	3/8" BSP	AS 10 RC 3/8	3,16	STA AS 10 RC 3/8	1,91
10	S	1/2" BSP	AS 10 RC 1/2	3,49	STA AS 10 RC 1/2	2,24
12	S	1/4" BSP	AS 12 RC 1/4	3,16	STA AS 12 RC 1/4	1,85
12	S	3/8" BSP	AS 12 RC 3/8	3,14	STA AS 12 RC 3/8	1,83
12	S	1/2" BSP	AS 12 RC 1/2	3,81	STA AS 12 RC 1/2	2,50
14	S	3/8" BSP	AS 14 RC 3/8	4,02	STA AS 14 RC 3/8	1,96
14	S	1/2" BSP	AS 14 RC 1/2	4,75	STA AS 14 RC 1/2	2,69
16	S	3/8" BSP	AS 16 RC 3/8	4,80	STA AS 16 RC 3/8	2,60
16	S	1/2" BSP	AS 16 RC 1/2	4,78	STA AS 16 RC 1/2	2,58
16	S	3/4" BSP	AS 16 RC 3/4	6,11	STA AS 16 RC 3/4	3,91
20	S	1/2" BSP	AS 20 RC 1/2	7,59	STA AS 20 RC 1/2	4,46
20	S	3/4" BSP	AS 20 RC 3/4	7,12	STA AS 20 RC 3/4	3,99
25	S	3/4" BSP	AS 25 RC 3/4	11,85	STA AS 25 RC 3/4	6,54
25	S	1" BSP	AS 25 RC 1	11,27	STA AS 25 RC 1	5,96
30	S	1" BSP	AS 30 RC 1	15,85	STA AS 30 RC 1	8,06
30	S	1" 1/4 BSP	AS 30 RC 1 1/4	18,12	STA AS 30 RC 1 1/4	10,33
38	S	1" 1/4 BSP	AS 38 RC 1 1/4	17,56	STA AS 38 RC 1 1/4	7,58
38	S	1" 1/2 BSP	AS 38 RC 1 1/2	23,41	STA AS 38 RC 1 1/2	13,43

Racores DIN 2353

DIN 2353 Pipe fittings
Raccords à bague DIN 2353
Raccordi ad anello DIN 2353

Racor recto rosca cilíndrica BSP

Straight male stud coupling BSP cyl

Union simple mâle gaz cyl

Raccordo di estremità diritto BSP

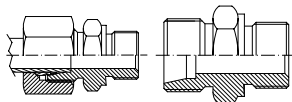

T.	S.	THREAD ROSCA	Part nº Referencia	€	Part Nº STA Referencia STA	€
6	L	1/8" BSP	AL 6 R 1/8	1,91	STA AL 6 R 1/8	0,99
6	L	1/4" BSP	AL 6 R 1/4	2,15	STA AL 6 R 1/4	1,23
6	L	3/8" BSP	AL 6 R 3/8	2,55	STA AL 6 R 3/8	1,63
6	L	1/2" BSP	AL 6 R 1/2	2,78	STA AL 6 R 1/2	1,86
8	L	1/8" BSP	AL 8 R 1/8	2,03	STA AL 8 R 1/8	1,13
8	L	1/4" BSP	AL 8 R 1/4	2,20	STA AL 8 R 1/4	1,30
8	L	3/8" BSP	AL 8 R 3/8	2,63	STA AL 8 R 3/8	1,73
8	L	1/2" BSP	AL 8 R 1/2	3,66	STA AL 8 R 1/2	2,76
10	L	1/8" BSP	AL 10 R 1/8	2,65	STA AL 10 R 1/8	1,57
10	L	1/4" BSP	AL 10 R 1/4	2,30	STA AL 10 R 1/4	1,22
10	L	3/8" BSP	AL 10 R 3/8	2,69	STA AL 10 R 3/8	1,61
10	L	1/2" BSP	AL 10 R 1/2	3,18	STA AL 10 R 1/2	2,10
12	L	1/4" BSP	AL 12 R 1/4	2,70	STA AL 12 R 1/4	1,51
12	L	1/2" BSP	AL 12 R 1/2	3,26	STA AL 12 R 1/2	2,07
12	L	3/4" BSP	AL 12 R 3/4	3,95	STA AL 12 R 3/4	2,76
12	L	3/8" BSP	AL 12 R 3/8	2,43	STA AL 12 R 3/8	1,24
15	L	3/8" BSP	AL 15 R 3/8	3,30	STA AL 15 R 3/8	1,73
15	L	1/2" BSP	AL 15 R 1/2	3,64	STA AL 15 R 1/2	2,07
15	L	3/4" BSP	AL 15 R 3/4	4,24	STA AL 15 R 3/4	2,67
18	L	1/2" BSP	AL 18 R 1/2	4,35	STA AL 18 R 1/2	2,16
18	L	3/4" BSP	AL 18 R 3/4	6,04	STA AL 18 R 3/4	3,85
18	L	3/8" BSP	AL 18 R 3/8	4,05	STA AL 18 R 3/8	1,86
22	L	1/2" BSP	AL 22 R 1/2	6,37	STA AL 22 R 1/2	3,44
22	L	3/4" BSP	AL 22 R 3/4	6,19	STA AL 22 R 3/4	3,26
22	L	1" BSP	AL 22 R 1	10,27	STA AL 22 R 1	7,34
28	L	3/4" BSP	AL 28 R 3/4	11,18	STA AL 28 R 3/4	6,98
28	L	1" BSP	AL 28 R 1	10,51	STA AL 28 R 1	6,31
35	L	1" BSP	AL 35 R 1	17,23	STA AL 35 R 1	10,74
35	L	1 1/4" BSP	AL 35 R 1 1/4	16,82	STA AL 35 R 1 1/4	10,33
42	L	1 1/2" BSP	AL 42 R 1 1/2	23,65	STA AL 42 R 1 1/2	14,48
6	S	1/4" BSP	AS 6 R 1/4	2,48	STA AS 6 R 1/4	1,52
8	S	1/4" BSP	AS 8 R 1/4	2,45	STA AS 8 R 1/4	1,44
8	S	3/8" BSP	AS 8 R 3/8	2,94	STA AS 8 R 3/8	1,93
10	S	1/4" BSP	AS 10 R 1/4	2,91	STA AS 10 R 1/4	1,66
10	S	3/8" BSP	AS 10 R 3/8	3,16	STA AS 10 R 3/8	1,91
10	S	1/2" BSP	AS 10 R 1/2	3,49	STA AS 10 R 1/2	2,24
12	S	1/4" BSP	AS 12 R 1/4	3,16	STA AS 12 R 1/4	1,85
12	S	3/8" BSP	AS 12 R 3/8	3,14	STA AS 12 R 3/8	1,83
12	S	1/2" BSP	AS 12 R 1/2	3,81	STA AS 12 R 1/2	2,50
14	S	3/8" BSP	AS 14 R 3/8	4,02	STA AS 14 R 3/8	1,96
14	S	1/2" BSP	AS 14 R 1/2	4,75	STA AS 14 R 1/2	2,69
16	S	3/8" BSP	AS 16 R 3/8	4,80	STA AS 16 R 3/8	2,60
16	S	1/2" BSP	AS 16 R 1/2	4,78	STA AS 16 R 1/2	2,58
16	S	3/4" BSP	AS 16 R 3/4	6,11	STA AS 16 R 3/4	3,91
20	S	1/2" BSP	AS 20 R 1/2	7,59	STA AS 20 R 1/2	4,46
20	S	3/4" BSP	AS 20 R 3/4	7,12	STA AS 20 R 3/4	3,99
25	S	3/4" BSP	AS 25 R 3/4	11,85	STA AS 25 R 3/4	6,54
25	S	1" BSP	AS 25 R 1	11,27	STA AS 25 R 1	5,96
30	S	1" BSP	AS 30 R 1	15,85	STA AS 30 R 1	8,06
30	S	1 1/4" BSP	AS 30 R 1 1/4	18,12	STA AS 30 R 1 1/4	10,33
38	S	1 1/4" BSP	AS 38 R 1 1/4	17,56	STA AS 38 R 1 1/4	7,58
38	S	1 1/2" BSP	AS 38 R 1 1/2	23,41	STA AS 38 R 1 1/2	13,43

Hasta fin de existencias / Until end of stock / Jusqu'à la fin du stock / Fino ad esaurimento scorta

Racor recto rosca cilíndrica BSP con junta

Straight male stud coupling with captive seal BSP cyl

Union simple mâle gaz cyl avec joint plat

Raccordo di estremità diritto BSP con guarnizione

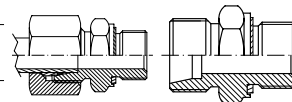

T.	S.	THREAD ROSCA	Part nº Referencia	€	Part Nº STA Referencia STA	€
6	L	1/8" BSP	AL 6 R 1/8 WD	2,23	STA AL 6 R 1/8 WD	1,31
6	L	1/4" BSP	AL 6 R 1/4 WD	2,63	STA AL 6 R 1/4 WD	1,71
6	L	3/8" BSP	AL 6 R 3/8 WD	2,80	STA AL 6 R 3/8 WD	1,88
8	L	1/8" BSP	AL 8 R 1/8 WD	2,14	STA AL 8 R 1/8 WD	1,24
8	L	1/4" BSP	AL 8 R 1/4 WD	2,30	STA AL 8 R 1/4 WD	1,40
8	L	3/8" BSP	AL 8 R 3/8 WD	2,54	STA AL 8 R 3/8 WD	1,64
8	L	1/2" BSP	AL 8 R 1/2 WD	4,11	STA AL 8 R 1/2 WD	3,21
10	L	1/8" BSP	AL 10 R 1/8 WD	2,69	STA AL 10 R 1/8 WD	1,61
10	L	1/4" BSP	AL 10 R 1/4 WD	2,28	STA AL 10 R 1/4 WD	1,20
10	L	3/8" BSP	AL 10 R 3/8 WD	2,72	STA AL 10 R 3/8 WD	1,64
10	L	1/2" BSP	AL 10 R 1/2 WD	3,43	STA AL 10 R 1/2 WD	2,35
12	L	1/4" BSP	AL 12 R 1/4 WD	2,54	STA AL 12 R 1/4 WD	1,35
12	L	3/8" BSP	AL 12 R 3/8 WD	2,64	STA AL 12 R 3/8 WD	1,45
12	L	1/2" BSP	AL 12 R 1/2 WD	3,54	STA AL 12 R 1/2 WD	2,35
12	L	3/4" BSP	AL 12 R 3/4 WD	5,65	STA AL 12 R 3/4 WD	4,46
15	L	3/8" BSP	AL 15 R 3/8 WD	3,79	STA AL 15 R 3/8 WD	2,22
15	L	1/2" BSP	AL 15 R 1/2 WD	3,92	STA AL 15 R 1/2 WD	2,35
15	L	3/4" BSP	AL 15 R 3/4 WD	5,68	STA AL 15 R 3/4 WD	4,11
18	L	3/8" BSP	AL 18 R 3/8 WD	5,16	STA AL 18 R 3/8 WD	2,97
18	L	1/2" BSP	AL 18 R 1/2 WD	4,69	STA AL 18 R 1/2 WD	2,50
18	L	3/4" BSP	AL 18 R 3/4 WD	5,65	STA AL 18 R 3/4 WD	3,46
22	L	1/2" BSP	AL 22 R 1/2 WD	6,37	STA AL 22 R 1/2 WD	3,44
22	L	3/4" BSP	AL 22 R 3/4 WD	6,43	STA AL 22 R 3/4 WD	3,50
22	L	1" BSP	AL 22 R 1 WD	9,41	STA AL 22 R 1 WD	6,48
28	L	3/4" BSP	AL 28 R 3/4 WD	10,68	STA AL 28 R 3/4 WD	6,48
28	L	1" BSP	AL 28 R 1 WD	11,19	STA AL 28 R 1 WD	6,99
35	L	1 1/4" BSP	AL 35 R 1 1/4 WD	17,48	STA AL 35 R 1 1/4 WD	10,99
42	L	1 1/2" BSP	AL 42 R 1 1/2 WD	25,40	STA AL 42 R 1 1/2 WD	16,23
6	S	1/4" BSP	AS 6 R 1/4 WD	2,68	STA AS 6 R 1/4 WD	1,72
8	S	1/4" BSP	AS 8 R 1/4 WD	2,61	STA AS 8 R 1/4 WD	1,60
8	S	3/8" BSP	AS 8 R 3/8 WD	3,19	STA AS 8 R 3/8 WD	2,18
10	S	1/4" BSP	AS 10 R 1/4 WD	3,01	STA AS 10 R 1/4 WD	1,76
10	S	3/8" BSP	AS 10 R 3/8 WD	3,55	STA AS 10 R 3/8 WD	2,30
10	S	1/2" BSP	AS 10 R 1/2 WD	3,42	STA AS 10 R 1/2 WD	2,17
12	S	1/4" BSP	AS 12 R 1/4 WD	3,27	STA AS 12 R 1/4 WD	1,96
12	S	3/8" BSP	AS 12 R 3/8 WD	3,22	STA AS 12 R 3/8 WD	1,91
12	S	1/2" BSP	AS 12 R 1/2 WD	4,00	STA AS 12 R 1/2 WD	2,69
14	S	3/4" BSP	AS 14 R 3/8 WD	4,64	STA AS 14 R 3/8 WD	2,58
14	S	1/2" BSP	AS 14 R 1/2 WD	4,97	STA AS 14 R 1/2 WD	2,91
16	S	3/8" BSP	AS 16 R 3/8 WD	4,77	STA AS 16 R 3/8 WD	2,57
16	S	1/2" BSP	AS 16 R 1/2 WD	4,84	STA AS 16 R 1/2 WD	2,64
16	S	3/4" BSP	AS 16 R 3/4 WD	4,96	STA AS 16 R 3/4 WD	2,76
20	S	1/2" BSP	AS 20 R 1/2 WD	8,13	STA AS 20 R 1/2 WD	5,00
20	S	3/4" BSP	AS 20 R 3/4 WD	7,24	STA AS 20 R 3/4 WD	4,11
25	S	3/4" BSP	AS 25 R 3/4 WD	12,51	STA AS 25 R 3/4 WD	7,20
25	S	1" BSP	AS 25 R 1 WD	12,30	STA AS 25 R 1 WD	6,99
30	S	1" BSP	AS 30 R 1 WD	17,76	STA AS 30 R 1 WD	9,97
30	S	1 1/4" BSP	AS 30 R 1 1/4 WD	20,21	STA AS 30 R 1 1/4 WD	12,42
38	S	1 1/4" BSP	AS 38 R 1 1/4 WD	37,41	STA AS 38 R 1 1/4 WD	27,43
38	S	1 1/2" BSP	AS 38 R 1 1/2 WD	28,77	STA AS 38 R 1 1/2 WD	18,79

Racores DIN 2353

DIN 2353 Pipe fittings
Raccords à bague DIN 2353
Raccordi ad anello DIN 2353

Racor recto rosca cónica NPT

Straight male stud coupling NPT

Union simple mâle NPT

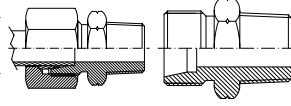

Raccordo di estremità diritto NPT conico

T.	S.	THREAD ROSCA	Part nº Referencia	€	Part Nº STA Referencia STA	€
6	LL	1/8" NPT	AKLL 6 1/8 NPT	1,90	STA AKLL 6 1/8 NPT	1,05
8	LL	1/8" NPT	AKLL 8 1/8 NPT	2,78	*	*
6	L	1/8" NPT	AKL 6 1/8 NPT	2,05	STA AKL 6 1/8 NPT	1,13
6	L	1/4" NPT	AKL 6 1/4 NPT	2,38	STA AKL 6 1/4 NPT	1,46
8	L	1/4" NPT	AKL 8 1/4 NPT	2,30	STA AKL 8 1/4 NPT	1,40
10	L	1/4" NPT	AKL 10 1/4 NPT	2,94	STA AKL 10 1/4 NPT	1,86
10	L	3/8" NPT	AKL 10 3/8 NPT	3,31	STA AKL 10 3/8 NPT	2,23
12	L	1/4" NPT	AKL 12 1/4 NPT	2,53	STA AKL 12 1/4 NPT	1,34
12	L	3/8" NPT	AKL 12 3/8 NPT	2,98	STA AKL 12 3/8 NPT	1,79
12	L	1/2" NPT	AKL 12 1/2 NPT	3,93	STA AKL 12 1/2 NPT	2,74
15	L	1/2" NPT	AKL 15 1/2 NPT	4,36	STA AKL 15 1/2 NPT	2,79
18	L	1/2" NPT	AKL 18 1/2 NPT	5,15	STA AKL 18 1/2 NPT	2,96
22	L	3/4" NPT	AKL 22 3/4 NPT	7,09	STA AKL 22 3/4 NPT	4,16
28	L	1" NPT	AKL 28 1 NPT	14,80	STA AKL 28 1 NPT	10,60
35	L	1 1/4" NPT	AKL 35 1 1/4 NPT	29,30	STA AKL 35 1 1/4 NPT	22,81
42	L	1 1/2" NPT	AKL 42 1 1/2 NPT	40,10	STA AKL 42 1 1/2 NPT	30,93
6	S	1/4" NPT	AKS 6 1/4 NPT	2,41	STA AKS 6 1/4 NPT	1,45
8	S	1/4" NPT	AKS 8 1/4 NPT	2,95	STA AKS 8 1/4 NPT	1,94
10	S	1/4" NPT	AKS 10 1/4 NPT	2,36	STA AKS 10 1/4 NPT	1,11
10	S	3/8" NPT	AKS 10 3/8 NPT	3,44	STA AKS 10 3/8 NPT	2,19
12	S	3/8" NPT	AKS 12 3/8 NPT	4,05	STA AKS 12 3/8 NPT	2,74
12	S	1/2" NPT	AKS 12 1/2 NPT	3,76	STA AKS 12 1/2 NPT	2,45
14	S	1/2" NPT	AKS 14 1/2 NPT	4,47	STA AKS 14 1/2 NPT	2,41
16	S	1/2" NPT	AKS 16 1/2 NPT	5,39	STA AKS 16 1/2 NPT	3,19
20	S	3/4" NPT	AKS 20 3/4 NPT	7,81	STA AKS 20 3/4 NPT	4,68
25	S	1" NPT	AKS 25 1 NPT	12,87	STA AKS 25 1 NPT	7,56
30	S	1 1/4" NPT	AKS 30 1 1/4 NPT	32,16	STA AKS 30 1 1/4 NPT	24,37
38	S	1 1/2" NPT	AKS 38 1 1/2 NPT	44,68	STA AKS 38 1 1/2 NPT	34,70

Racor recto rosca cilíndrica UNF

Straight male stud coupling UNF

Union simple mâle UNF

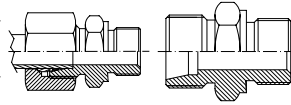

Raccordo di estremità diritto UNF

T.	S.	THREAD ROSCA	Part nº Referencia	€	Part Nº STA Referencia STA	€
10	L	7/16" UNF	AL 10 7/16 UNF	*	STA AL 10 7/16 UNF	2,11
12	L	3/4" UNF	AL 12 3/4 UNF	*	STA AL 12 3/4 UNF	10,83
12	L	7/8" UNF	AL 12 7/8 UNF	*	STA AL 12 7/8 UNF	3,54
15	L	3/4" UNF	AL 15 3/4 UNF	*	STA AL 15 3/4 UNF	3,66
18	L	3/4" UNF	AL 18 3/4 UNF	*	STA AL 18 3/4 UNF	3,53
18	L	7/8" UNF	AL 18 7/8 UNF	*	STA AL 18 7/8 UNF	3,46
22	L	7/8" UNF	AL 22 7/8 UNF	*	STA AL 22 7/8 UNF	15,09
22	L	1" 1/16 UNF	AL 22 1 1/16 UNF	*	STA AL 22 1 1/16 UNF	15,42
22	L	1" 5/16 UNF	AL 22 1 5/16 UNF	*	STA AL 22 1 5/16 UNF	18,91
28	L	1" 1/16 UNF	AL 28 1 1/16 UNF	*	STA AL 28 1 1/16 UNF	19,12
28	L	1" 5/16 UNF	AL 28 1 5/16 UNF	*	STA AL 28 1 5/16 UNF	19,21
35	L	1" 5/16 UNF	AL 35 1 5/16 UNF	*	STA AL 35 1 5/16 UNF	24,84
35	L	1" 5/8 UNF	AL 35 1 5/8 UNF	*	STA AL 35 1 5/8 UNF	28,32
8	S	7/16" UNF	AS 8 7/16 UNF	*	STA AS 8 7/16 UNF	9,24
10	S	9/16" UNF	AS 10 9/16 UNF	*	STA AS 10 9/16 UNF	9,99
12	S	9/16" UNF	AS 12 9/16 UNF	*	STA AS 12 9/16 UNF	10,82
20	S	3/4" UNF	AS 20 3/4 UNF	*	STA AS 20 3/4 UNF	15,53
20	S	7/8" UNF	AS 20 7/8 UNF	*	STA AS 20 7/8 UNF	16,14
20	S	1" 1/16 UNF	AS 20 1 1/16 UNF	*	STA AS 20 1 1/16 UNF	16,90
25	S	1" 5/16 UNF	AS 25 1 5/16 UNF	*	STA AS 25 1 5/16 UNF	20,62

Racor recto rosca cilíndrica Métrica con junta

Straight male stud coupling with captive seal Metrical cyl

Union simple mâle Métrique cyl + joint plat

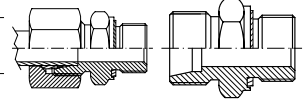

Raccordo di estremità diritto cilindrico Metrico con guarnizione

T.	S.	THREAD ROSCA	Part nº Referencia	€	Part Nº STA Referencia STA	€
6	L	M10x1	AL 6 M 10X1 WD	2,24	STA AL 6 M 10X1 WD	1,32
8	L	M12x1,5	AL 8 M 12X1.5 WD	2,60	STA AL 8 M 12X1.5 WD	1,70
10	L	M14x1,5	AL 10 M 14X1.5 WD	2,60	STA AL 10 M 14X1.5 WD	1,52
10	L	M16x1,5	AL 10 M 16X1.5 WD	3,45	STA AL 10 M 16X1.5 WD	2,37
10	L	M18x1,5	AL 10 M 18X1.5 WD	4,28	STA AL 10 M 18X1.5 WD	3,20
10	L	M22x1,5	AL 10 M 22X1.5 WD	4,71	STA AL 10 M 22X1.5 WD	3,63
12	L	M16x1,5	AL 12 M 16X1.5 WD	3,08	STA AL 12 M 16X1.5 WD	1,89
12	L	M22x1,5	AL 12 M 22X1.5 WD	4,81	STA AL 12 M 22X1.5 WD	3,62
15	L	M18x1,5	AL 15 M 18X1.5 WD	4,40	STA AL 15 M 18X1.5 WD	2,83
15	L	M22x1,5	AL 15 M 22X1.5 WD	5,24	STA AL 15 M 22X1.5 WD	3,67
18	L	M18x1,5	AL 18 M 18X1.5 WD	11,71	STA AL 18 M 18X1.5 WD	9,52
18	L	M22x1,5	AL 18 M 22X1.5 WD	5,14	STA AL 18 M 22X1.5 WD	2,95
22	L	M26x1,5	AL 22 M 26X1.5 WD	8,59	STA AL 22 M 26X1.5 WD	5,66
28	L	M33x2	AL 28 M 33X2 WD	11,76	STA AL 28 M 33X2 WD	7,56
35	L	M42x2	AL 35 M 42X2 WD	21,39	STA AL 35 M 42X2 WD	14,90
42	L	M48x2	AL 42 M 48X2 WD	36,88	STA AL 42 M 48X2 WD	27,71
6	S	M12x1,5	AS 6 M 12X1.5 WD	2,33	STA AS 6 M 12X1.5 WD	1,37
10	S	M16x1,5	AS 10 M 16X1.5 WD	3,23	STA AS 10 M 16X1.5 WD	1,98
12	S	M18x1,5	AS 12 M 18X1.5 WD	4,34	STA AS 12 M 18X1.5 WD	3,03
14	S	M20x1,5	AS 14 M 20X1.5 WD	4,71	STA AS 14 M 20X1.5 WD	2,65
16	S	M22x1,5	AS 16 M 22X1.5 WD	6,15	STA AS 16 M 22X1.5 WD	3,95
25	S	M33x2	AS 25 M 33X2 WD	12,22	STA AS 25 M 33X2 WD	6,91
30	S	M42x2	AS 30 M 42X2 WD	19,84	STA AS 30 M 42X2 WD	12,05
38	S	M48x2	AS 38 M 48X2 WD	26,05	STA AS 38 M 48X2 WD	16,07

Racor recto rosca cónica Métrica

Straight male stud coupling metrical tapered

Union simple mâle métrique type A

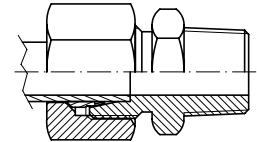

Raccordo di estremità diritto conico Metrico

PIPE TUBO	SERIE	THREAD ROSCA	Part nº Referencia	€
4	LL	M 8x1	AKLL 4 M 8X1	2,08
6	LL	M 10x1	AKLL 6 M 10X1	2,04
8	LL	M 10x1	AKLL 8 M 10X1	2,16

Racores DIN 2353

DIN 2353 Pipe fittings
Raccords à bague DIN 2353
Raccordi ad anello DIN 2353

Reducción con rosca M-HF BSP con junta

Male-female reducing adaptor BSP cyl with captive seal

Réduction mâle gaz-femelle gaz avec joint plat

Adattatore di riduzione filettato maschio-femmina BSP con guarnizione

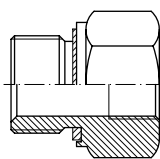

THREAD ROSCA		Part nº Referencia	€
M 1/8" BSP	F 1/4" BSP	RI-R 1/8 R 1/4WD	1,90
M 1/8" BSP	F 3/8" BSP	RI-R 1/8 R 3/8WD	2,76
M 1/4" BSP	F 1/8" BSP	RI-R 1/4 R 1/8WD	1,86
M 1/4" BSP	F 3/8" BSP	RI-R 1/4 R 3/8WD	2,94
M 1/4" BSP	F 1/2" BSP	RI-R 1/4 R 1/2 WD	5,00
M 1/4" BSP	F 3/4" BSP	RI-R 1/4 R 3/4 WD	13,15
M 3/8" BSP	F 1/8" BSP	RI-R 3/8 R 1/8WD	2,03
M 3/8" BSP	F 1/4" BSP	RI-R 3/8 R 1/4 WD	2,54
M 3/8" BSP	F 1/2" BSP	RI-R 3/8 R 1/2WD	5,05
M 3/8" BSP	F 3/4" BSP	RI-R 3/8 R 3/4WD	7,40
M 1/2" BSP	F 1/8" BSP	RI-R 1/2 R 1/8WD	2,98
M 1/2" BSP	F 1/4" BSP	RI-R 1/2 R 1/4WD	2,94
M 1/2" BSP	F 3/8" BSP	RI-R 1/2 R 3/8WD	3,63
M 1/2" BSP	F 3/4" BSP	RI-R 1/2 R 3/4WD	7,60
M 1/2" BSP	F 1" BSP	RI-R 1/2 R 1WD	9,36
M 1/2" BSP	F 1 1/4 BSP	RI-R 1/2 R 1 1/4WD	26,78
M 3/4" BSP	F 1/4" BSP	RI-R 3/4 R 1/4WD	4,63
M 3/4" BSP	F 3/8" BSP	RI-R 3/4 R 3/8WD	4,63
M 3/4" BSP	F 1/2" BSP	RI-R 3/4 R 1/2WD	5,69
M 3/4" BSP	F 1" BSP	RI-R 3/4 R 1WD	9,67
M 3/4" BSP	F 1 1/4 BSP	RI-R 3/4 R 1 1/4WD	17,95
M 3/4" BSP	F 1 1/2 BSP	RI-R 3/4 R 1 1/2WD	32,49
M 1" BSP	F 1/4" BSP	RI-R 1 R 1/4WD	7,55
M 1" BSP	F 3/8" BSP	RI-R 1 R 3/8WD	7,55
M 1" BSP	F 1/2" BSP	RI-R 1 R 1/2WD	7,55
M 1" BSP	F 3/4" BSP	RI-R 1 R 3/4WD	9,51
M 1" BSP	F 1 1/4 BSP	RI-R 1 R 1 1/4WD	18,68
M 1" BSP	F 1 1/2 BSP	RI-R 1 R 1 1/2WD	33,28
M 1 1/4 BSP	F 1/2" BSP	RI-R 1 1/4 R 1/2WD	11,96
M 1 1/4 BSP	F 3/4" BSP	RI-R 1 1/4 R 3/4WD	11,96
M 1 1/4 BSP	F 1" BSP	RI-R 1 1/4 R 1WD	15,38
M 1 1/4 BSP	F 1 1/2 BSP	RI-R 1 1/4 R 1 1/2WD	34,08
M 1 1/2 BSP	F 1/2" BSP	RI-R 1 1/2 R 1/2WD	14,78
M 1 1/2 BSP	F 3/4" BSP	RI-R 1 1/2 R 3/4WD	14,78
M 1 1/2 BSP	F 1" BSP	RI-R 1 1/2 R 1WD	14,78
M 1 1/2 BSP	F 1 1/4 BSP	RI-R 1 1/2 R 1 1/4WD	19,58

Racores DIN 2353

DIN 2353 Pipe fittings
Raccords à bague DIN 2353
Raccordi ad anello DIN 2353

Racor en codo rosca cónica BSPT

Male stud elbow BSPT conical

Union coude mâle conique BSPT

Raccordo a gomito, conico BSPT

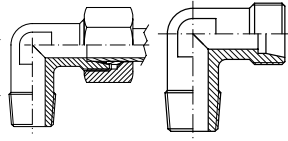

T.	S.	THREAD ROSCA	Part nº Referencia	€	Part Nº STA Referencia STA	€
4	LL	1/8" BSPT	CKLL 4 R 1/8	3,52	STA CKLL 4 R 1/8	2,68
6	LL	1/8" BSPT	CKLL 6 R 1/8	3,53	STA CKLL 6 R 1/8	2,68
8	LL	1/8" BSPT	CKLL 8 R 1/8	4,07	STA CKLL 8 R 1/8	3,11
6	L	1/8" BSPT	CKL 6 R 1/8	3,57	STA CKL 6 R 1/8	2,65
6	L	1/4" BSPT	CKL 6 R 1/4	3,82	STA CKL 6 R 1/4	2,90
8	L	1/8" BSPT	CKL 8 R 1/8	4,54	STA CKL 8 R 1/8	3,64
8	L	1/4" BSPT	CKL 8 R 1/4	4,22	STA CKL 8 R 1/4	3,32
8	L	3/8" BSPT	CKL 8 R 3/8	5,74	STA CKL 8 R 3/8	4,84
10	L	1/4" BSPT	CKL 10 R 1/4	4,46	STA CKL 10 R 1/4	3,38
10	L	3/8" BSPT	CKL 10 R 3/8	4,46	STA CKL 10 R 3/8	3,38
10	L	1/2" BSPT	CKL 10 R 1/2	7,56	STA CKL 10 R 1/2	6,48
12	L	1/4" BSPT	CKL 12 R 1/4	4,63	STA CKL 12 R 1/4	3,44
12	L	3/8" BSPT	CKL 12 R 3/8	4,43	STA CKL 12 R 3/8	3,24
12	L	1/2" BSPT	CKL 12 R 1/2	6,72	STA CKL 12 R 1/2	5,53
15	L	3/8" BSPT	CKL 15 R 3/8	6,51	STA CKL 15 R 3/8	4,94
15	L	1/2" BSPT	CKL 15 R 1/2	7,11	STA CKL 15 R 1/2	5,54
18	L	1/2" BSPT	CKL 18 R 1/2	10,29	STA CKL 18 R 1/2	8,10
22	L	3/4" BSPT	CKL 22 R 3/4	13,07	STA CKL 22 R 3/4	10,14
28	L	1" BSPT	CKL 28 R 1	24,65	STA CKL 28 R 1	20,45
35	L	1 1/4" BSPT	CKL 35 R 1 1/4	38,19	STA CKL 35 R 1 1/4	31,70
42	L	1 1/2" BSPT	CKL 42 R 1 1/2	58,81	STA CKL 42 R 1 1/2	49,64
6	S	1/4" BSPT	CKS 6 R 1/4	4,71	STA CKS 6 R 1/4	3,75
8	S	1/4" BSPT	CKS 8 R 1/4	5,29	STA CKS 8 R 1/4	4,28
10	S	3/8" BSPT	CKS 10 R 3/8	6,11	STA CKS 10 R 3/8	4,86
12	S	3/8" BSPT	CKS 12 R 3/8	6,51	STA CKS 12 R 3/8	5,20
12	S	1/2" BSPT	CKS 12 R 1/2	6,25	STA CKS 12 R 1/2	4,94
14	S	1/2" BSPT	CKS 14 R 1/2	11,25	STA CKS 14 R 1/2	9,19
16	S	1/2" BSPT	CKS 16 R 1/2	8,65	STA CKS 16 R 1/2	6,45
20	S	3/4" BSPT	CKS 20 R 3/4	17,55	STA CKS 20 R 3/4	14,42
25	S	1" BSPT	CKS 25 R 1	33,33	STA CKS 25 R 1	28,02
30	S	1 1/4" BSPT	CKS 30 R 1 1/4	56,50	STA CKS 30 R 1 1/4	48,71
38	S	1 1/2" BSPT	CKS 38 R 1 1/2	80,96	STA CKS 38 R 1 1/2	70,98

Racor en codo rosca cónica Métrica

Male stud elbow Metrical conical

Union coude mâle conique Métrique

Raccordo a gomito, conico Metrico

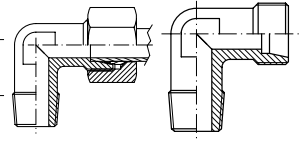

T.	S.	THREAD ROSCA	Part nº Referencia	€	Part Nº STA Referencia STA	€
4	LL	M8x1	CKLL 4 M 8X1	3,39	STA CKLL 4 M 8X1	2,55
6	LL	M10x1	CKLL 6 M 10X1	3,62	STA CKLL 6 M 10X1	2,77
8	LL	M10x1	CKLL 8 M 10X1	4,23	STA CKLL 8 M 10X1	3,27
6	L	M10x1	CKL 6 M 10X1	4,53	STA CKL 6 M 10X1	3,61
8	L	M12x1,5	CKL 8 M 12X1.5	4,72	STA CKL 8 M 12X1.5	*
10	L	M14x1,5	CKL 10 M 14X1.5	5,85	STA CKL 10 M 14X1.5	*
12	L	M16x1,5	CKL 12 M 16X1.5	6,60	STA CKL 12 M 16X1.5	5,41
15	L	M18x1,5	CKL 15 M 18X1.5	8,83	STA CKL 15 M 18X1.5	7,26
6	S	M12x1,5	CKS 6 M 12X1.5	23,12	STA CKS 6 M 12X1.5	22,16
8	S	M14x1,5	CKS 8 M 14X1.5	23,73	STA CKS 8 M 14X1.5	22,72
10	S	M16x1,5	CKS 10 M 16X1.5	6,71	STA CKS 10 M 16X1.5	5,46
14	S	M20x1,5	CKS 14 M 20X1.5	27,62	STA CKS 14 M 20X1.5	25,56
16	S	M22x1,5	CKS 16 M 22X1.5	31,41	STA CKS 16 M 22X1.5	29,21

Racor en codo rosca cónica NPT

Male stud elbow NPTconical

Union coude mâle gaz conique NPT

Raccordo a gomito, conico NPT

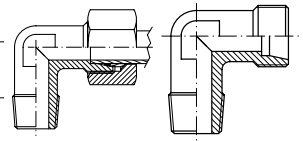

T.	S.	THREAD ROSCA	Part nº Referencia	€	Part Nº STA Referencia STA	€
4	LL	1/8" NPT	CKLL 4 1/8 NPT	6,72	STA CKLL 4 1/8 NPT	5,88
6	LL	1/8" NPT	CKLL 6 1/8 NPT	3,34	STA CKLL 6 1/8 NPT	2,49
8	LL	1/8" NPT	CKLL 8 1/8 NPT	7,26		*
6	L	1/8" NPT	CKL 6 1/8 NPT	2,95	STA CKL 6 1/8 NPT	2,03
6	L	1/4" NPT	CKL 6 1/4 NPT	4,57	STA CKL 6 1/4 NPT	3,65
8	L	1/4" NPT	CKL 8 1/4 NPT	4,55	STA CKL 8 1/4 NPT	3,65
10	L	1/4" NPT	CKL 10 1/4 NPT	5,24	STA CKL 10 1/4 NPT	4,16
12	L	1/4" NPT	CKL 12 1/4 NPT	6,00	STA CKL 12 1/4 NPT	4,81
12	L	3/8" NPT	CKL 12 3/8 NPT	5,85	STA CKL 12 3/8 NPT	4,66
12	L	1/2" NPT	CKL 12 1/2 NPT	7,69	STA CKL 12 1/2 NPT	6,50
15	L	1/2" NPT	CKL 15 1/2 NPT	8,82	STA CKL 15 1/2 NPT	7,25
18	L	1/2" NPT	CKL 18 1/2 NPT	10,29	STA CKL 18 1/2 NPT	8,10
22	L	3/4" NPT	CKL 22 3/4 NPT	16,11	STA CKL 22 3/4 NPT	13,18
28	L	1" NPT	CKL 28 1 NPT	24,65	STA CKL 28 1 NPT	20,45
35	L	1 1/4" NPT	CKL 35 1 1/4 NPT	55,20	STA CKL 35 1 1/4 NPT	48,71
42	L	1 1/2" NPT	CKL 42 1 1/2 NPT	80,15	STA CKL 42 1 1/2 NPT	70,98
6	S	1/4" NPT	CKS 6 1/4 NPT	6,87	STA CKS 6 1/4 NPT	5,91
8	S	1/4" NPT	CKS 8 1/4 NPT	7,98	STA CKS 8 1/4 NPT	6,97
10	S	3/8" NPT	CKS 10 3/8 NPT	8,66	STA CKS 10 3/8 NPT	7,41
12	S	3/8" NPT	CKS 12 3/8 NPT	6,85	STA CKS 12 3/8 NPT	5,54
14	S	1/2" NPT	CKS 14 1/2 NPT	24,80	STA CKS 14 1/2 NPT	22,74
16	S	1/2" NPT	CKS 16 1/2 NPT	10,08	STA CKS 16 1/2 NPT	7,88
20	S	3/4" NPT	CKS 20 3/4 NPT	14,60	STA CKS 20 3/4 NPT	11,47
25	S	1" NPT	CKS 25 1 NPT	24,69	STA CKS 25 1 NPT	19,38
30	S	1 1/4" NPT	CKS 30 1 1/4 NPT	56,50	STA CKS 30 1 1/4 NPT	48,71
38	S	1 1/2" NPT	CKS 38 1 1/2 NPT	80,96	STA CKS 38 1 1/2 NPT	70,98

Racores DIN 2353

DIN 2353 Pipe fittings
Raccords à bague DIN 2353
Raccordi ad anello DIN 2353

Tubing Pipe

Pipe Fittings, DIN 2353 / Flare fittings, JC 37°

SAE Flanges

Tubing Clamps

Machines for processing rigid pipes

Racor de reducción TL Métrica (serie ligera)

Standpipe reducer swivel femelle (light series)

Union simple femelle tournante Métrique (L)

Raccordo di riduzione cono 24 (L)

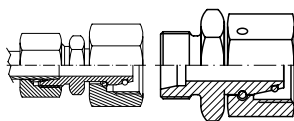

T.	S.	Part nº Referencia	€	Part Nº STA Referencia STA	€
6	8	L KORL 8-6TLM	4,88	STA KORL 8-6TLM	3,06
6	10	L KORL 10-6TLM	5,53	STA KORL 10-6 TLM	3,53
8	10	L KORL 10-8 TLM	4,79	STA KORL 10-8 TLM	2,81
6	12	L KORL 12-6TLM	5,38	STA KORL 12-6 TLM	3,27
8	12	L KORL 12-8TLM	3,95	STA KORL 12-8 TLM	1,86
10	12	L KORL 12-10TLM	5,69	STA KORL 12-10 TLM	3,42
6	15	L KORL 15-6TLM	14,70	STA KORL 15-6 TLM	12,21
8	15	L KORL 15-8TLM	7,78	STA KORL 15-8 TLM	5,31
10	15	L KORL 15-10TLM	6,74	STA KORL 15-10 TLM	4,09
12	15	L KORL 15-12TLM	6,55	STA KORL 15-12 TLM	3,79
6	18	L KORL 18-6TLM	18,24	STA KORL 18-6 TLM	15,13
8	18	L KORL 18-8TLM	18,23	STA KORL 18-8 TLM	15,14
10	18	L KORL 18-10TLM	8,47	STA KORL 18-10 TLM	5,20
12	18	L KORL 18-12TLM	9,87	STA KORL 18-12 TLM	6,49
15	18	L KORL 18-15TLM	11,07	STA KORL 18-15 TLM	7,31
6	22	L KORL 22-6TLM *	19,62		*
8	22	L KORL 22-8TLM *	19,85		*
10	22	L KORL 22-10TLM	20,88	STA KORL 22-10 TLM	16,87
12	22	L KORL 22-12TLM	13,25	STA KORL 22-12 TLM	9,13
15	22	L KORL 22-15TLM	13,63	STA KORL 22-15 TLM	9,13
18	22	L KORL 22-18TLM	12,87	STA KORL 22-18 TLM	7,75
6	28	L KORL 28-6TLM *	23,84		*
10	28	L KORL 28-10TLM *	24,40		*
12	28	L KORL 28-12TLM	26,13	STA KORL 28-12 TLM	20,74
15	28	L KORL 28-15TLM	18,42	STA KORL 28-15 TLM	12,65
18	28	L KORL 28-18TLM	19,04	STA KORL 28-18 TLM	12,65
22	28	L KORL 28-22TLM	17,01	STA KORL 28-22 TLM	9,88
15	35	L KORL 35-15TLM	37,67	STA KORL 35-15 TLM	29,61
18	35	L KORL 35-18TLM	38,29	STA KORL 35-18 TLM	29,61
22	35	L KORL 35-22TLM	25,64	STA KORL 35-22 TLM	16,22
28	35	L KORL 35-28TLM	33,21	STA KORL 35-28 TLM	22,52
18	42	L KORL 42-18TLM	57,88	STA KORL 42-18 TLM	46,52
22	42	L KORL 42-22TLM	59,16	STA KORL 42-22 TLM	47,06
28	42	L KORL 42-28TLM	60,74	STA KORL 42-28 TLM	47,37
35	42	L KORL 42-35TLM	39,66	STA KORL 42-35 TLM	24,00

*Hasta fin de existencias / *Until end of stock / *Jusqu'à la fin du stock / *Fino ad esaurimento scorta

Racor de reducción TL Métrica (serie pesada)

Standpipe reducer swivel femelle (heavy series)

Union simple femelle tournante Métrique (S)

Raccordo di riduzione cono 24 (S)

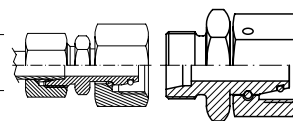

T.	S.	Part nº Referencia	€	Part Nº STA Referencia STA	€
6	8	S KORS 8-6TLM	12,63	STA KORS 8-6 TLM	10,66
6	10	S KORS 10-6TLM	13,88	STA KORS 10-6 TLM	11,67
8	10	S KORS 10-8TLM	13,82	STA KORS 10-8 TLM	11,56
6	12	S KORS 12-6TLM	14,14	STA KORS 12-6 TLM	11,87
8	12	S KORS 12-8TLM	14,19	STA KORS 12-8 TLM	11,87
10	12	S KORS 12-10TLM	7,61	STA KORS 12-10 TLM	5,05
6	14	S KORS 14-6TLM	16,44	STA KORS 14-6 TLM	13,46
8	14	S KORS 14-8TLM	16,55	STA KORS 14-8 TLM	13,48
10	14	S KORS 14-10TLM	16,79	STA KORS 14-10 TLM	13,48
12	14	S KORS 14-12TLM	8,22	STA KORS 14-12 TLM	4,85
8	16	S KORS 16-8TLM	10,25	STA KORS 16-8 TLM	7,04
10	16	S KORS 16-10TLM	19,01	STA KORS 16-10 TLM	15,56
12	16	S KORS 16-12TLM	9,08	STA KORS 16-12 TLM	5,57
14	16	S KORS 16-14TLM	20,56	STA KORS 16-14 TLM	16,30
6	20	S KORS 20-6TLM	22,55	STA KORS 20-6 TLM	18,64
8	20	S KORS 20-8TLM	22,78	STA KORS 20-8 TLM	18,64
10	20	S KORS 20-10TLM	23,02	STA KORS 20-10 TLM	18,64
12	20	S KORS 20-12TLM	14,89	STA KORS 20-12 TLM	10,45
14	20	S KORS 20-14TLM	17,54	STA KORS 20-14 TLM	12,35
16	20	S KORS 20-16TLM	14,17	STA KORS 20-16 TLM	8,84
6	25	S KORS 25-6TLM	29,10	STA KORS 25-6 TLM	22,83
8	25	S KORS 25-8TLM	29,15	STA KORS 25-8 TLM	22,83
10	25	S KORS 25-10TLM	29,39	STA KORS 25-10 TLM	22,83
12	25	S KORS 25-12TLM	20,16	STA KORS 25-12 TLM	13,54
14	25	S KORS 25-14TLM	30,81	STA KORS 25-14 TLM	23,44
16	25	S KORS 25-16TLM	17,21	STA KORS 25-16 TLM	9,70
20	25	S KORS 25-20TLM	19,69	STA KORS 25-20 TLM	11,25
12	30	S KORS 30-12TLM	37,33	STA KORS 30-12 TLM	*
16	30	S KORS 30-16TLM	40,53	STA KORS 30-16 TLM	*
20	30	S KORS 30-20TLM	34,75	STA KORS 30-20 TLM	*
25	30	S KORS 30-25TLM	42,11	STA KORS 30-25 TLM	*
16	38	S KORS 38-16TLM	55,64	STA KORS 38-16 TLM	*
20	38	S KORS 38-20TLM	60,24	STA KORS 38-20 TLM	*
25	38	S KORS 38-25TLM	67,80	STA KORS 38-25 TLM	*
30	38	S KORS 38-30TLM	72,81	STA KORS 38-30 TLM	*

Racor en codo regulable con tuerca y anillo

Adjustable stud elbow with nut and ring

Coude orientable tube lisse équipé

Raccordo orientabile a 90° con dado e anello

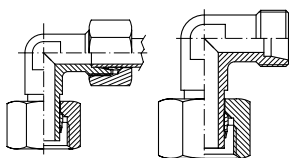

PIPE TUBO	SERIE	THREAD ROSCA	Part nº Referencia	€	Part Nº STA Referencia STA	€
6	L	M12x1,5	EEL 6 CTA	5,99	STA EEL 6 CTA	5,07
8	L	M14x1,5	EEL 8 CTA	6,47	STA EEL 8 CTA	5,58
15	L	M22x1,5	EEL 15 CTA	8,53	STA EEL 15 CTA	6,96
18	L	M26x1,5	EEL 18 CTA	10,64	STA EEL 18 CTA	8,45
22	L	M30x2	EEL 22 CTA	14,71	STA EEL 22 CTA	11,78
12	S	M20x1,5	EES 12 CTA	*	STA EES 12 CTA	6,12
25	S	M36x2	EES 25 CTA	29,78	STA EES 25 CTA	24,47

Hasta fin de existencias. / Until end of stock. / Jusqu'à la fin du stock. / Fino ad esaurimento scorta.

Racores DIN 2353

DIN 2353 Pipe fittings
Raccords à bague DIN 2353
Raccordi ad anello DIN 2353

Racor en codo tubo-TL Métrica

Adjustable stud elbow with o'ring

Coude orientable Métrique + o'ring

Raccordo orientabile a 90° con o'ring

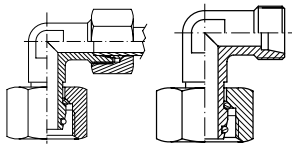

PIPE TUBO	SERIE	THREAD ROSCA	Part nº Referencia	€	Part Nº STA Referencia STA	€
6	L	M12x1,5	EEL 6 TLM	5,99	STA EEL 6 TLM	5,07
8	L	M14x1,5	EEL 8 TLM	6,48	STA EEL 8 TLM	5,58
10	L	M16x1,5	EEL 10 TLM	5,90	STA EEL 10 TLM	4,82
12	L	M18x1,5	EEL 12 TLM	6,08	STA EEL 12 TLM	4,89
15	L	M22x1,5	EEL 15 TLM	8,53	STA EEL 15 TLM	6,96
18	L	M26x1,5	EEL 18 TLM	10,64	STA EEL 18 TLM	8,45
22	L	M30x2	EEL 22 TLM	14,71	STA EEL 22 TLM	11,78
28	L	M36x2	EEL 28 TLM	22,41	STA EEL 28 TLM	18,21
35	L	M45x2	EEL 35 TLM	43,98	STA EEL 35 TLM	37,49
42	L	M52x2	EEL 42 TLM	67,53	STA EEL 42 TLM	58,36
6	S	M14x1,5	EES 6 TLM	5,85	STA EES 6 TLM	4,89
8	S	M16x1,5	EES 8 TLM	6,52	STA EES 8 TLM	5,51
10	S	M18x1,5	EES 10 TLM	7,37	STA EES 10 TLM	6,12
12	S	M20x1,5	EES 12 TLM	7,43	STA EES 12 TLM	6,12
14	S	M22x1,5	EES 14 TLM	9,77	STA EES 14 TLM	7,71
16	S	M24x1,5	EES 16 TLM	12,60	STA EES 16 TLM	10,40
20	S	M30x2	EES 20 TLM	16,59	STA EES 20 TLM	13,46
25	S	M36x2	EES 25 TLM	29,78	STA EES 25 TLM	24,47
30	S	M42x2	EES 30 TLM	47,02	STA EES 30 TLM	39,23
38	S	M52x2	EES 38 TLM	69,47	STA EES 38 TLM	59,49

Racor en L tubo-TL Métrica

Adjustable stud barrel L with o'ring

L Orientable renversé Métrique + o'ring

Raccordo orientabile a T con o'ring laterale

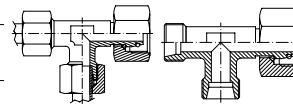

PIPE TUBO	SERIE	THREAD ROSCA	Part nº Referencia	€	Part Nº STA Referencia STA	€
6	L	M12x1,5	LEL 6 TLM	7,38	STA LEL 6 TLM	5,54
8	L	M14x1,5	LEL 8 TLM	7,56	STA LEL 8 TLM	5,76
10	L	M16x1,5	LEL 10 TLM	8,05	STA LEL 10 TLM	5,89
12	L	M18x1,5	LEL 12 TLM	9,31	STA LEL 12 TLM	6,93
15	L	M22x1,5	LEL 15 TLM	12,08	STA LEL 15 TLM	8,94
18	L	M26x1,5	LEL 18 TLM	15,63	STA LEL 18 TLM	11,25
22	L	M30x2	LEL 22 TLM	22,48	STA LEL 22 TLM	16,62
28	L	M36x2	LEL 28 TLM	36,81	STA LEL 28 TLM	28,41
35	L	M45x2	LEL 35 TLM	49,69	STA LEL 35 TLM	36,71
42	L	M52x2	LEL 42 TLM	75,69	STA LEL 42 TLM	57,35
6	S	M14x1,5	LES 6 TLM	8,06	STA LES 6 TLM	6,14
8	S	M16x1,5	LES 8 TLM	8,56	STA LES 8 TLM	6,54
10	S	M18x1,5	LES 10 TLM	11,68	STA LES 10 TLM	9,18
12	S	M20x1,5	LES 12 TLM	12,28	STA LES 12 TLM	9,66
14	S	M22x1,5	LES 14 TLM	16,02	STA LES 14 TLM	11,90
16	S	M24x1,5	LES 16 TLM	16,84	STA LES 16 TLM	12,44
20	S	M30x2	LES 20 TLM	22,90	STA LES 20 TLM	16,64
25	S	M36x2	LES 25 TLM	42,74	STA LES 25 TLM	32,12
30	S	M42x2	LES 30 TLM	55,65	STA LES 30 TLM	40,07
38	S	M52x2	LES 38 TLM	84,85	STA LES 38 TLM	64,89

Racor en T tubo-TL Métrica

Adjustable stud branch TEE with o'ring

Té Orientable Métrique + o'ring

Raccordo orientabile a T con o'ring centrale

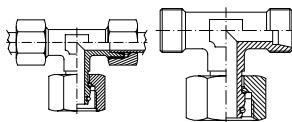

PIPE TUBO	SERIE	THREAD ROSCA	Part nº Referencia	€	Part Nº STA Referencia STA	€
6	L	M12x1,5	TEL 6 TLM	7,38	STA TEL 6 TLM	5,54
8	L	M14x1,5	TEL 8 TLM	7,56	STA TEL 8 TLM	5,76
10	L	M16x1,5	TEL 10 TLM	8,05	STA TEL 10 TLM	5,89
12	L	M18x1,5	TEL 12 TLM	9,28	STA TEL 12 TLM	6,90
15	L	M22x1,5	TEL 15 TLM	12,08	STA TEL 15 TLM	8,94
18	L	M26x1,5	TEL 18 TLM	17,23	STA TEL 18 TLM	12,85
22	L	M30x2	TEL 22 TLM	21,53	STA TEL 22 TLM	15,67
28	L	M36x2	TEL 28 TLM	38,22	STA TEL 28 TLM	29,82
35	L	M45x2	TEL 35 TLM	49,69	STA TEL 35 TLM	36,71
42	L	M52x2	TEL 42 TLM	75,69	STA TEL 42 TLM	57,35
6	S	M14x1,5	TES 6 TLM	8,23	STA TES 6 TLM	6,31
8	S	M16x1,5	TES 8 TLM	8,54	STA TES 8 TLM	6,52
10	S	M18x1,5	TES 10 TLM	11,68	STA TES 10 TLM	9,18
12	S	M20x1,5	TES 12 TLM	11,20	STA TES 12 TLM	8,58
14	S	M22x1,5	TES 14 TLM	13,30	STA TES 14 TLM	9,18
16	S	M24x1,5	TES 16 TLM	17,25	STA TES 16 TLM	12,85
20	S	M30x2	TES 20 TLM	23,39	STA TES 20 TLM	17,13
25	S	M36x2	TES 25 TLM	42,74	STA TES 25 TLM	32,12
30	S	M42x2	TES 30 TLM	56,87	STA TES 30 TLM	41,29
38	S	M52x2	TES 38 TLM	100,00	STA TES 38 TLM	80,04

Racores DIN 2353

DIN 2353 Pipe fittings
Raccords à bague DIN 2353
Raccordi ad anello DIN 2353

Tr/Ale pipe

Pipe fittings, DIN 2353
/ Flare fittings, JIC 37°

SAE Flanges

Tr/Ale clamps

Machines for
processing rigid pipes

Racor unión TL-TL Métrica

Straight connection with o'ring

Union tournante Métrique égale

Raccordo di estremità diritto Metrico con o'ring

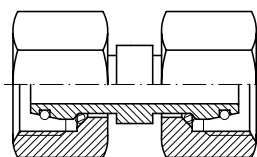

PIPE TUBO	SERIE	Part nº Referencia	€
6	L	ATL 6	8,50
8	L	ATL 8	3,89
10	L	ATL 10	4,44
12	L	ATL 12	5,28
15	L	ATL 15	6,81
18	L	ATL 18	8,61
22	L	ATL 22	17,36
28	L	ATL 28	21,26
35	L	ATL 35	32,38
42	L	ATL 42	51,59
6	S	ATS 6	8,94
8	S	ATS 8	9,83
10	S	ATS 10	10,91
12	S	ATS 12	11,78
14	S	ATS 14	13,52
16	S	ATS 16	8,34
20	S	ATS 20	18,31
25	S	ATS 25	23,86
30	S	ATS 30	35,47
38	S	ATS 38	53,59

Tubo roscado recto BSP TLM con junta

Straight stud standpipe adpt. w/captive seal & o'ring BSP cyl

Adapteur tube lisse x mâle gaz a/écrou + o'ring

Adattatore diritto BSP TLM

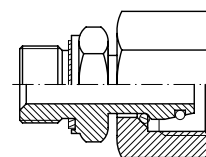

PIPE TUBO	SERIE	THREAD ROSCA	Part nº Referencia	€
6	L	1/8"BSP	RAL 6 TLM R 1/8	2,40
8	L	1/4"BSP	RAL 8 TLM R 1/4	2,86
10	L	1/4"BSP	RAL 10 TLM R 1/4	3,75
12	L	3/8"BSP	RAL 12 TLM R 3/8	3,64
15	L	1/2"BSP	RAL 15 TLM R 1/2	4,58
18	L	1/2"BSP	RAL 18 TLM R 1/2	4,78
22	L	3/4"BSP	RAL 22 TLM R 3/4	5,86
28	L	1"BSP	RAL 28 TLM R 1	10,16
35	L	1"1/4BSP	RAL 35 TLM R 1 1/4	19,40
42	L	1"1/2 BSP	RAL 42 TLM R 1 1/2	27,72
6	S	1/4"BSP	RAS 6 TLM R 1/4	2,84
8	S	1/4"BSP	RAS 8 TLM R 1/4	3,02
10	S	3/8"BSP	RAS 10 TLM R 3/8	2,95
12	S	3/8"BSP	RAS 12 TLM R 3/8	3,96
14	S	1/2"BSP	RAS 14 TLM R 1/2	4,35
16	S	1/2"BSP	RAS 16 TLM R 1/2	4,94
20	S	3/4"BSP	RAS 20 TLM R 3/4	7,48
25	S	1"BSP	RAS 25 TLM R 1	12,94
30	S	1"1/4BSP	RAS 30 TLM R 1 1/4	21,89
38	S	1"1/2BSP	RAS 38 TLM R 1 1/2	35,14

Tubo roscado recto métrico TLM con junta

Straight stud metric standpipe adpt. w/captive seal-o'ring Met. cyl

Adapteur tube lisse x mâle met.a/écrou Met.+o'ring

Adattatore diritto Metrico TLM

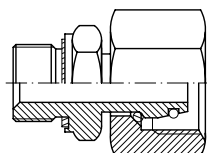

PIPE TUBO	SERIE	THREAD ROSCA	Part nº Referencia	€
6	L	M10X1	RAL 6 TLM M 10X1	10,19
8	L	M12X1.5	RAL 8 TLM M 12X1.5	11,29
10	L	M14X1.5	RAL 10 TLM M 14X1.5	12,64
12	L	M16X1.5	RAL 12 TLM M 16X1.5	14,32
15	L	M18X1.5	RAL 15 TLM M 18X1.5	15,31
18	L	M22X1.5	RAL 18 TLM M 22X1.5	17,11
22	L	M26X1.5	RAL 22 TLM M 26X1.5	21,92
28	L	M33X2	RAL 28 TLM M 33X2	31,27
35	L	M42X2	RAL 35 TLM M 42X2	47,77
42	L	M48X2	RAL 42 TLM M 48X2	63,99
6	S	M12X1.5	RAS 6 TLM M 12X1.5	11,07
8	S	M14X1.5	RAS 8 TLM M 14X1.5	12,91
10	S	M16X1.5	RAS 10 TLM M 16X1.5	14,63
12	S	M18X1.5	RAS 12 TLM M 18X1.5	15,68
14	S	M20X1.5	RAS 14 TLM M 20X1.5	18,20
16	S	M22X1.5	RAS 16 TLM M 22X1.5	14,71
20	S	M27X2	RAS 20 TLM M 27X2	24,59
25	S	M33X2	RAS 25 TLM M 33X2	28,05
30	S	M42X2	RAS 30 TLM M 42X2	51,72
38	S	M48X2	RAS 38 TLM M 48X2	69,49

Racores DIN 2353

DIN 2353 Pipe fittings

Raccords à bague DIN 2353

Raccordi ad anello DIN 2353

Racor recto para soldar

Welding straight coupling

Mamelon hexagonal à souder Métrique (DIN 2353) équipé avec bague et écrou

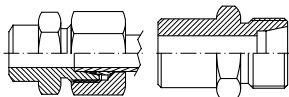

Raccordo diritto a saldare

PIPE TUBO	SERIE	Part n° Referencia	€	Part N° STA Referencia STA	€
6	L	ASL 6	2,01	STA ASL 6	1,09
8	L	ASL 8	2,12	STA ASL 8	1,22
10	L	ASL 10	2,46	STA ASL 10	1,38
12	L	ASL 12	2,58	STA ASL 12	1,39
15	L	ASL 15	3,17	STA ASL 15	1,60
18	L	ASL 18	4,57	STA ASL 18	2,38
22	L	ASL 22	6,79	STA ASL 22	3,86
28	L	ASL 28	10,63	STA ASL 28	6,43
35	L	ASL 35	15,15	STA ASL 35	8,66
42	L	ASL 42	22,89	STA ASL 42	13,72
6	S	ASS 6	9,61	STA ASS 6	8,65
8	S	ASS 8	10,25	STA ASS 8	9,24
10	S	ASS 10	5,31	STA ASS 10	4,06
12	S	ASS 12	6,43	STA ASS 12	5,12
14	S	ASS 14	4,28	STA ASS 14	2,22
16	S	ASS 16	5,09	STA ASS 16	2,89
20	S	ASS 20	7,15	STA ASS 20	4,02
25	S	ASS 25	12,76	STA ASS 25	7,45
30	S	ASS 30	16,74	STA ASS 30	8,95
38	S	ASS 38	24,47	STA ASS 38	14,49

Racor pasatabique para soldar

Weldable bulkhead coupling

Union double passe cloison Métrique à souder

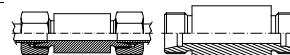

Raccordo passaparete a saldare

PIPE TUBO	SERIE	Part n° Referencia	€	Part N° STA Referencia STA	€
6	L	ESVL 6	16,58	STA ESVL 6	14,74
8	L	ESVL 8	16,22	STA ESVL 8	14,42
10	L	ESVL 10	20,01	STA ESVL 10	17,85
12	L	ESVL 12	18,28	STA ESVL 12	15,90
15	L	ESVL 15	24,45	STA ESVL 15	21,31
18	L	ESVL 18	29,25	STA ESVL 18	24,87
22	L	ESVL 22	28,74	STA ESVL 22	22,88
28	L	ESVL 28	31,71	STA ESVL 28	23,31
35	L	ESVL 35	49,50	STA ESVL 35	36,52
42	L	ESVL 42	65,39	STA ESVL 42	47,05
6	S	ESVS 6	17,06	STA ESVS 6	15,14
8	S	ESVS 8	20,38	STA ESVS 8	18,36
10	S	ESVS 10	18,84	STA ESVS 10	16,34
12	S	ESVS 12	21,47	STA ESVS 12	18,85
14	S	ESVS 14	29,66	STA ESVS 14	25,54
16	S	ESVS 16	26,23	STA ESVS 16	21,83
20	S	ESVS 20	28,52	STA ESVS 20	22,26
25	S	ESVS 25	42,49	STA ESVS 25	31,87
30	S	ESVS 30	55,35	STA ESVS 30	39,77
38	S	ESVS 38	70,17	STA ESVS 38	50,21

Boquilla para soldar

Welding nipple

Collet cône Métrique (DIN 2353) à souder (BW) o'ring

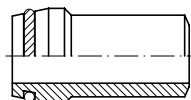

Ogiva a saldare

PIPE TUBO	SERIE	Part n° Referencia	€
15X2.5	L	ORIL 15	3,90
18X2.5	L	ORIL 18	4,51
22X2.5	L	ORIL 22	4,77
28X3	L	ORIL 28	5,98
35X4	L	ORIL 35	6,50
42X3	L	ORIL 42	7,40
6X2	L/S	ORIS 6	1,11
8X2	L/S	ORIS 8	1,20
8X1.5	L/S	ORIS 8X1.5	1,32
10X2	L/S	ORIS 10X2	1,43
12X2	L/S	ORIS 12	1,32
12X2.5	S	ORIS 12X2.5	1,65
14X2	L/S	ORIS 14X2	4,91
14X3	S	ORIS 14X3	10,29
16X2	S	ORIS 16X2	5,10
16X2.5	S	ORIS 16X2.5	5,10
16X3	S	ORIS 16X3	2,64
20X2.5	S	ORIS 20X2.5	6,96
20X3	S	ORIS 20X3	6,96
20X4	S	ORIS 20X4	2,97
25X4	S	ORIS 25X4	3,96
30x4	S	ORIS 30X4	11,54
30x5	S	ORIS 30X5	5,57
38x5	S	ORIS 38X5	9,35

Racores DIN 2353

DIN 2353 Pipe fittings
Raccords à bague DIN 2353
Raccordi ad anello DIN 2353

Tri/Ale pipe

Pipe fittings DIN 2353
/ Flare fittings JIC 37°

SAE Flanges

Tri/Ale Clamps

Machines for
processing rigid pipes

Racor recto pasatabiques con tuerca

Straight bulkhead coupling

Union double passe cloison

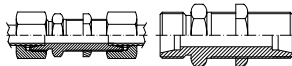

Raccordo passaparete

PIPE TUBO	SERIE	Part nº Referencia	€	Part Nº STA Referencia STA	€
6	L	SVL 6	3,95	STA SVL 6	2,11
8	L	SVL 8	4,40	STA SVL 8	2,60
10	L	SVL 10	5,29	STA SVL 10	3,13
12	L	SVL 12	6,23	STA SVL 12	3,85
15	L	SVL 15	7,95	STA SVL 15	4,81
18	L	SVL 18	11,30	STA SVL 18	6,92
22	L	SVL 22	15,06	STA SVL 22	9,20
28	L	SVL 28	20,84	STA SVL 28	12,44
35	L	SVL 35	33,53	STA SVL 35	20,55
42	L	SVL 42	49,37	STA SVL 42	31,03
6	S	SVS 6	4,93	STA SVS 6	3,01
8	S	SVS 8	5,38	STA SVS 8	3,36
10	S	SVS 10	6,53	STA SVS 10	4,03
12	S	SVS 12	7,66	STA SVS 12	5,04
14	S	SVS 14	11,32	STA SVS 14	7,20
16	S	SVS 16	11,98	STA SVS 16	7,58
20	S	SVS 20	17,79	STA SVS 20	11,53
25	S	SVS 25	29,69	STA SVS 25	19,07
30	S	SVS 30	40,78	STA SVS 30	25,20
38	S	SVS 38	89,66	STA SVS 38	69,70

Racor en codo pasatabiques con tuerca

Elbow bulkhead coupling

Coude égal passe cloison

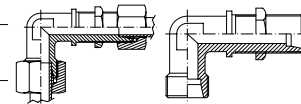

Raccordo passaparete a 90°

PIPE TUBO	SERIE	Part nº Referencia	€	Part Nº STA Referencia STA	€
6	L	USVL 6	7,64	STA USVL 6	5,80
8	L	USVL 8	7,75	STA USVL 8	5,95
10	L	USVL 10	8,22	STA USVL 10	6,06
12	L	USVL 12	10,38	STA USVL 12	8,00
15	L	USVL 15	11,82	STA USVL 15	8,68
18	L	USVL 18	15,51	STA USVL 18	11,13
22	L	USVL 22	19,58	STA USVL 22	13,72
28	L	USVL 28	34,25	STA USVL 28	25,85
35	L	USVL 35	45,97	STA USVL 35	32,99
42	L	USVL 42	74,50	STA USVL 42	56,16
8	S	USVS 8	9,65	STA USVS 8	7,63
10	S	USVS 10	9,81	STA USVS 10	7,31
12	S	USVS 12	11,22	STA USVS 12	8,60
14	S	USVS 14	12,52	STA USVS 14	8,40
16	S	USVS 16	16,23	STA USVS 16	11,83
20	S	USVS 20	22,98	STA USVS 20	16,72
25	S	USVS 25	39,15	STA USVS 25	28,53
30	S	USVS 30	51,24	STA USVS 30	35,66
38	S	USVS 38	86,82	STA USVS 38	66,86

Tuerca pasatabiques Métrica

Metric nut bulkhead

Ecrou passe cloison Métrique

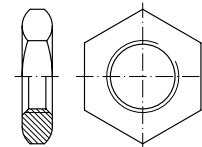

Dado passaparete Metrico

THREAD ROSCA	Part nº Referencia	€
M 12x1,5	TP 06 L	0,49
M 14x1,5	TP 08 L	0,62
M 16x1,5	TP 10 L	0,64
M 18x1,5	TP 12 L	0,76
M 22x1,5	TP 15 L	1,21
M 26x1,5	TP 18 L	1,82
M 30x2	TP 22 L	1,87
M 36x2	TP 28 L	2,29
M45x2	TP 35 L	2,45
M 52x2	TP 42 L	4,74
M 20x1,5	TP 12 S	0,89
M 24x1,5	TP 16 S	1,29
M 42x2	TP 30 S	2,45

Racores DIN 2353

DIN 2353 Pipe fittings
Raccords à bague DIN 2353
Raccordi ad anello DIN 2353

Racor recto hembra rosca BSP

Female stud coupling

Union simple femelle gaz

Raccordo diritto femmina BSP

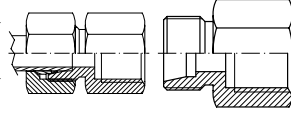

T.	S.	THREAD ROSCA	Part nº Referencia	€	Part Nº STA Referencia STA	€
6	L	1/8" BSP	GAIL 6 R 1/8	2,60	STA GAIL 6 R 1/8	1,68
8	L	1/4" BSP	GAIL 8 R 1/4	2,63	STA GAIL 8 R 1/4	1,73
10	L	1/4" BSP	GAIL 10 R 1/4	2,86	STA GAIL 10 R 1/4	1,78
10	L	3/8" BSP	GAIL 10 R 3/8	3,21	STA GAIL 10 R 3/8	2,13
10	L	1/2" BSP	GAIL 10 R 1/2	4,98	STA GAIL 10 R 1/2	3,90
12	L	3/8" BSP	GAIL 12 R 3/8	3,30	STA GAIL 12 R 3/8	2,11
12	L	1/2" BSP	GAIL 12 R 1/2	4,00	STA GAIL 12 R 1/2	2,81
15	L	3/4" BSP	GAIL 15 R 1/2	4,21	STA GAIL 15 R 1/2	2,64
18	L	1/2" BSP	GAIL 18 R 1/2	4,97	STA GAIL 18 R 1/2	2,78
22	L	3/4" BSP	GAIL 22 R 3/4	7,35	STA GAIL 22 R 3/4	4,42
28	L	1" BSP	GAIL 28 R 1	11,43	STA GAIL 28 R 1	7,23
35	L	1"1/4 BSP	GAIL 35 R 1 1/4	40,83	STA GAIL 35 R 1 1/4	34,34
42	L	1"1/2 BSP	GAIL 42 R 1 1/2	50,21	STA GAIL 42 R 1 1/2	41,04
6	S	1/4" BSP	GAIS 6 R 1/4	3,12	STA GAIS 6 R 1/4	2,16
8	S	1/4" BSP	GAIS 8 R 1/4	3,17	STA GAIS 8 R 1/4	2,16
10	S	3/8" BSP	GAIS 10 R 3/8	4,46	STA GAIS 10 R 3/8	3,21
14	S	1/2" BSP	GAIS 14 R 1/2	5,31	STA GAIS 14 R 1/2	3,25
16	S	1/2" BSP	GAIS 16 R 1/2	5,66	STA GAIS 16 R 1/2	3,46
20	S	3/4" BSP	GAIS 20 R 3/4	9,10	STA GAIS 20 R 3/4	5,97
25	S	1" BSP	GAIS 25 R 1	13,34	STA GAIS 25 R 1	8,03
30	S	1"1/4 BSP	GAIS 30 R 1 1/4	43,25	STA GAIS 30 R 1 1/4	35,46
38	S	1"1/2 BSP	GAIS 38 R 1 1/2	57,68	STA GAIS 38 R 1 1/2	47,70

Arandela para manómetros

Seal for gauge coupling

Bague pour manomètres

Guarnizioni per manometri

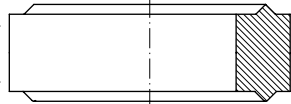

THREAD ROSCA	Part nº Referencia	€
1/4" BSP	AM 1/4	0,50
1/2" BSP	AM 1/2	0,79

Racor recto hembra rosca Métrica

Female stud coupling Metric cyl

Union simple femelle Métrique

Raccordo diritto femmina Metrico

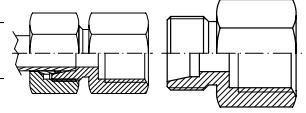

T.	S.	THREAD ROSCA	Part nº Referencia	€	Part Nº STA Referencia STA	€
6	L	M10x1	GAIL 6 M 10X1	8,99	STA GAIL 6 M 10X1	8,07
8	L	M12x1,5	GAIL 8 M 12X1.5	9,73	STA GAIL 8 M 12X1.5	8,83
10	L	M14X1.5	GAIL 10 M14X1.5	10,60	STA GAIL 10 M 14X1.5	9,52
12	L	M16X1.5	GAIL 12 M16X1.5	11,62	STA GAIL 12 M 16X1.5	10,43
15	L	M18X1.5	GAIL 15 M18X1.5	13,06	STA GAIL 15 M 18X1.5	11,49
16	S	M22x1,5	GAIS 16 M 22X1.5	16,53	STA GAIS 16 M 22X1.5	14,33
18	L	M22X1.5	GAIL 18 M22X1.5	16,35	STA GAIL 18 M 22X1.5	14,16
22	L	M26X1.5	GAIL 22 M26X1.5	17,95	STA GAIL 22 M 26X1.5	15,02
6	S	M12x1,5	GAIS 6 M 12X1.5	9,84	STA GAIS 6 M 12X1.5	8,88
8	S	M14x1,5	GAIS 8 M 14X1.5	10,58	STA GAIS 8 M 14X1.5	9,57
10	S	M16X1.5	GAIS 10 M16X1.5	11,73	STA GAIS 10 M 16X1.5	10,48
12	S	M18X1.5	GAIS 12 M18X1.5	12,55	STA GAIS 12 M 18X1.5	11,24
14	S	M20X1.5	GAIS 14 M20X1.5	14,28	STA GAIS 14 M 20X1.5	12,22
20	S	M27x2	GAIS 20 M 27X2	19,96	STA GAIS 20 M 27X2	16,83

Racor para manómetro BSP

Gauge coupling BSP cyl

Union pour manomètre gaz

Raccordo per manometri BSP

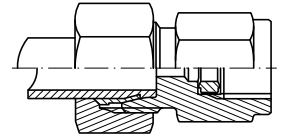

PIPE TUBO	SERIE	THREAD ROSCA	Part nº Referencia	€
6	L	1/4" BSP	MAVL 6 R 1/4	2,70
8	L	1/4" BSP	MAVL 8 R 1/4	2,68
10	L	1/4" BSP	MAVL 10 R 1/4	2,86
12	L	1/4" BSP	MAVL 12 R 1/4	2,92
6	S	1/2" BSP	MAVS 6 R 1/2	8,32
8	S	1/2" BSP	MAVS 8 R 1/2	8,48
10	S	1/2" BSP	MAVS 10 R 1/2	8,79
12	S	1/2" BSP	MAVS 12 R 1/2	9,21

Racores DIN 2353

DIN 2353 Pipe fittings
Raccords à bague DIN 2353
Raccordi ad anello DIN 2353

Racor en codo orientable sin estrangulador rosca BSP

Elbow banjo coupling with captive seal and o-ring
BSP cyl

Equerre orientable sans étrangleur gaz BSP
(passage total)

Raccordo orientabile a 90° ad occhio BSP con
guarnizione

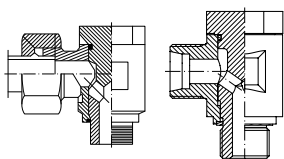

T.	S.	THREAD ROSCA	Part n° Referencia	€	Part N° STA Referencia STA	€
6	LL	1/8" BSP	WSVLL 6 R 1/8	10,02	STA WSVLL 6 R 1/8	9,17
8	LL	1/8" BSP	WSVLL 8 R 1/8	10,13	STA WSVLL 8 R 1/8	9,17
6	LL	1/8" BSP	WSVL 6 R 1/8	9,60	STA WSVL 6 R 1/8	8,68
8	L	1/4" BSP	WSVL 8 R 1/4	11,53	STA WSVL 8 R 1/4	10,63
10	L	1/4" BSP	WSVL 10 R 1/4	9,60	STA WSVL 10 R 1/4	8,52
12	L	1/4" BSP	WSVL 12 R 1/4	16,60	STA WSVL 12 R 1/4	15,41
12	L	3/8" BSP	WSVL 12 R 3/8	11,97	STA WSVL 12 R 3/8	10,78
15	L	1/2" BSP	WSVL 15 R 1/2	21,92	STA WSVL 15 R 1/2	20,35
18	L	1/2" BSP	WSVL 18 R 1/2	24,79	STA WSVL 18 R 1/2	22,60
22	L	3/4" BSP	WSVL 22 R 3/4	37,54	STA WSVL 22 R 3/4	34,61
28	L	1" BSP	WSVL 28 R 1	77,00	STA WSVL 28 R 1	72,80
35	L	1 1/4" BSP	WSVL 35 R 1 1/4	127,32	STA WSVL 35 R 1 1/4	120,83
42	L	1 1/2" BSP	WSVL 42 R 1 1/2	163,05	STA WSVL 42 R 1 1/2	153,88
6	L	1/4" BSP	WSVS 6 R 1/4	13,19	STA WSVS 6 R 1/4	12,23
8	S	1/4" BSP	WSVS 8 R 1/4	13,25	STA WSVS 8 R 1/4	12,24
10	S	3/8" BSP	WSVS 10 R 3/8	15,73	STA WSVS 10 R 3/8	14,48
12	S	3/8" BSP	WSVS 12 R 3/8	16,98	STA WSVS 12 R 3/8	15,67
14	S	1/2" BSP	WSVS 14 R 1/2	23,74	STA WSVS 14 R 1/2	21,68
16	S	1/2" BSP	WSVS 16 R 1/2	22,98	STA WSVS 16 R 1/2	20,78
20	S	3/4" BSP	WSVS 20 R 3/4	34,30	STA WSVS 20 R 3/4	31,17
25	S	1" BSP	WSVS 25 R 1	78,11	STA WSVS 25 R 1	72,80
30	S	1 1/4" BSP	WSVS 30 R 1 1/4	128,62	STA WSVS 30 R 1 1/4	120,83
38	S	1 1/2" BSP	WSVS 38 R 1 1/2	163,86	STA WSVS 38 R 1 1/2	153,88

Racor en codo orientable sin estrangulador rosca Métrica

Elbow banjo coupling with captive seal and o-ring
metric cyl

Equerre orientable sans étrangleur métrique
(passage total)

Raccordo orientabile a 90° ad occhio Metrico con
guarnizione

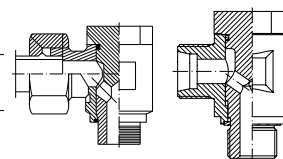

T.	S.	THREAD ROSCA	B	Part n° Referencia	€	Part N° STA Referencia STA	€
6	LL	M10X1	8	WSVLL 6 M 10X1	11,23	STA WSVLL 6 M 10X1	10,38
8	LL	M10X1	8	WSVLL 8 M 10X1	11,34	STA WSVLL 8 M 10X1	10,38
6	L	M10X1	8	WSVL 6 M 10X1	11,30	STA WSVL 6 M 10X1	10,38
8	L	M12X1.5	12	WSVL 8 M 12X1.5	14,67	STA WSVL 8 M 12X1.5	13,77
10	L	M14X1.5	12	WSVL 10 M 14X1.5	14,85	STA WSVL 10 M 14X1.5	13,77
12	L	M16X1.5	12	WSVL 12 M 16X1.5	19,93	STA WSVL 12 M 16X1.5	18,74
15	L	M18X1.5	12	WSVL 15 M 18X1.5	25,35	STA WSVL 15 M 18X1.5	23,78
18	L	M22X1.5	14	WSVL 18 M 22X1.5	28,23	STA WSVL 18 M 22X1.5	26,04
22	L	M26X1.5	16	WSVL 22 M 26X1.5	49,80	STA WSVL 22 M 26X1.5	46,87
28	L	M33X2	18	WSVL 28 M 33X2	86,14	STA WSVL 28 M 33X2	81,94
35	L	M42X2	20	WSVL 35 M 42X2	142,41	STA WSVL 35 M 42X2	135,92
42	L	M48X2	22	WSVL 42 M 48X2	182,28	STA WSVL 42 M 48X2	173,11
8	S	M14X1.5	12	WSVS 8 M 14X1.5	14,81	STA WSVS 8 M 14X1.5	13,80
10	S	M16X1.5	12	WSVS 10 M 16X1.5	20,01	STA WSVS 10 M 16X1.5	18,76
12	S	M18X1.5	12	WSVS 12 M 18X1.5	25,09	STA WSVS 12 M 18X1.5	23,78
16	S	M22X1.5	14	WSVS 16 M 22X1.5	28,24	STA WSVS 16 M 22X1.5	26,04
20	S	M27X2	16	WSVS 20 M 27X2	50,03	STA WSVS 20 M 27X2	46,90
25	S	M33X2	18	WSVS 25 M 33X2	87,25	STA WSVS 25 M 33X2	81,94
30	S	M42X2	20	WSVS 30 M 42X2	143,71	STA WSVS 30 M 42X2	135,92
38	S	M48X2	22	WSVS 38 M 48X2	183,09	STA WSVS 38 M 48X2	173,11

Racor en codo orientable BSP-Métrico

90° Adjustable male stud elbow BSP - Metric

Coude réglable mâle BSP - Métrique

Raccordo a 90° orientabile maschio BSP-Metrico

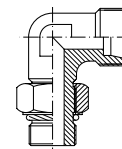

PIPE TUBO	SERIE	THREAD ROSCA		Part n° Referencia	€
6	L	M12X1,5	1/8" BSP	STA WEE 6L R 1/8	6,49
8	L	M14X1,5	1/4" BSP	STA WEE 8L R 1/4	7,38
10	L	M16X1,5	1/4" BSP	STA WEE 10L R 1/4	7,38
12	L	M18X1,5	3/8" BSP	STA WEE 12L R 3/8	9,62
15	L	M22X1,5	1/2" BSP	STA WEE 15L R 1/2	12,69
18	L	M26X1,5	1/2" BSP	STA WEE 18L R 1/2	18,09
22	L	M30X2	3/4" BSP	STA WEE 22L R 3/4	19,74
16	S	M24X1,5	1/2" BSP	STA WEE 16S R 1/2	19,99
20	S	M30X2	3/4" BSP	STA WEE 20S R 3/4	19,74
25	S	M36X2	1" BSP	STA WEE 25S R 1	39,66

Racores DIN 2353

DIN 2353 Pipe fittings
Raccords à bague DIN 2353
Raccordi ad anello DIN 2353

Tapón de cierre para tubo

Blanking plug with o'ring

Bouchon de fermeture avec o'ring

Tappo di chiusura con o'ring

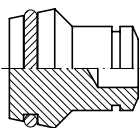

PIPE TUBO	SERIE	Part nº Referencia	€
6	L/S	BUTZEN L 6	0,62
8	L/S	BUTZEN L 8	0,79
10	L/S	BUTZEN L 10	0,94
12	L/S	BUTZEN L 12	0,93
15	L	BUTZEN L 15	1,26
18	L	BUTZEN L 18	1,28
22	L	BUTZEN L 22	1,96
28	L	BUTZEN L 28	2,37
35	L	BUTZEN L 35	4,64
42	L	BUTZEN L 42	6,85
14	S	BUTZEN S 14	1,56
16	S	BUTZEN S 16	1,16
20	S	BUTZEN S 20	1,70
25	S	BUTZEN S 25	2,10
30	S	BUTZEN S 30	3,65
38	S	BUTZEN S 38	6,49

Tapón macho métrico 24°

24° Metric Plug

Bouchon mâle métrique 24°

Tappo metrico 24°

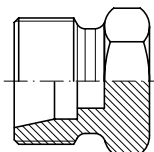

PIPE TUBO	SERIE	THREAD ROSCA	Part nº Referencia	€
6	L	12x1.5	STA TML 6	0,74
8	L	14x1.5	STA TML 8	0,89
10	L	16x1.5	STA TML 10	1,01
12	L	18x1.5	STA TML 12	1,07
15	L	22x1.5	STA TML 15	1,19
18	L	26x1.5	STA TML 18	1,80
22	L	30x2	STA TML 22	2,11
28	L	36x2	STA TML 28	3,47
35	L	45x2	STA TML 35	5,75
42	L	52x2	STA TML 42	29,65
6	S	14x1.5	STA TMS 6	0,99
8	S	16x1.5	STA TMS 8	1,58
10	S	18x1.5	STA TMS 10	1,06
12	S	20x1.5	STA TMS 12	1,31
14	S	22x1.5	STA TMS 14	1,75
16	S	24x1.5	STA TMS 16	1,73
20	S	30x2	STA TMS 20	2,86
25	S	36x2	STA TMS 25	4,66
30	S	42x2	STA TMS 30	7,10
38	S	52x2	STA TMS 38	10,08

Tapón de cierre Allen rosca BSP con junta

Blanking plug with captive seal BSP cyl

Bouchon Allen gaz avec o'ring

Tappo cilindrico BSP esagono incassato con o'ring

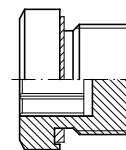

THREAD ROSCA	Part nº Referencia	€
1/8" BSP	STOPFEN 1/8	0,86
1/4" BSP	STOPFEN 1/4	1,03
3/8" BSP	STOPFEN 3/8	1,23
1/2" BSP	STOPFEN 1/2	1,56
3/4" BSP	STOPFEN 3/4	2,11
1" BSP	STOPFEN 1	3,47
1 1/4" BSP	STOPFEN 1 1/4	7,47
1 1/2" BSP	STOPFEN 1 1/2	7,71
2" BSP	STOPFEN 2	19,08

Tapón de cierre Allen rosca Métrica con junta

Blanking plug with captive seal Metric cyl

Bouchon Allen Métrique avec o'ring

Tappo cilindrico Metrico esagono incassato con
guarnizione

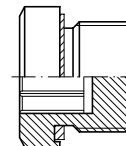

THREAD ROSCA	Part nº Referencia	€
M10X1	STOPFEN M 10X1	0,94
M12X1.25	STOPFEN M 12X1.25	1,19
M12X1.5	STOPFEN M 12X1.5	1,05
M14X1.5	STOPFEN M 14X1.5	1,21
M16X1.5	STOPFEN M 16X1.5	1,28
M18X1.5	STOPFEN M 18X1.5	1,43
M20X1.5	STOPFEN M 20X1.5	2,11
M22X1.5	STOPFEN M 22X1.5	1,50
M26X1.5	STOPFEN M 26X1.5	2,24
M27X2	STOPFEN M 27X2	2,24
M33X2	STOPFEN M 33X2	3,17
M42X2	STOPFEN M 42X2	7,55
M48X2	STOPFEN M 48X2	15,54

Racores DIN 2353

DIN 2353 Pipe fittings
Raccords à bague DIN 2353
Raccordi ad anello DIN 2353

Tubing

Pipe Fittings, DIN 2353
/ Flare fittings, JIC 37°

SAE Flanges

Tubing Clamps

Machines for
processing rigid pipes

Antirretorno tubo-tubo

Non-return valve tube-tube

Clapet antiretour bidirectional tube-tube

Valvola di ritegno tubo-tubo

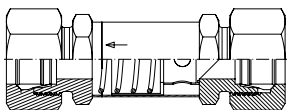

PIPE TUBO	SERIE	Part n° Referencia	€	Part N° STA Referencia STA	€
6	L	RHDL 6	22,91	STA RHDL 6	21,07
8	L	RHDL 8	23,83	STA RHDL 8	22,03
10	L	RHDL 10	28,28	STA RHDL 10	26,12
12	L	RHDL 12	34,04	STA RHDL 12	31,66
15	L	RHDL 15	38,41	STA RHDL 15	35,27
18	L	RHDL 18	54,10	STA RHDL 18	49,72
22	L	RHDL 22	76,28	STA RHDL 22	70,42
28	L	RHDL 28	131,78	STA RHDL 28	123,38
35	L	RHDL 35	193,54	STA RHDL 35	180,56
42	L	RHDL 42	480,30	STA RHDL 42	461,96
6	S	RHDS 6	23,23	STA RHDS 6	21,31
8	S	RHDS 8	23,33	STA RHDS 8	21,31
10	S	RHDS 10	28,74	STA RHDS 10	26,24
12	S	RHDS 12	33,32	STA RHDS 12	30,70
14	S	RHDS 14	40,23	STA RHDS 14	36,11
16	S	RHDS 16	50,14	STA RHDS 16	45,74
20	S	RHDS 20	63,80	STA RHDS 20	57,54
25	S	RHDS 25	98,49	STA RHDS 25	87,87
30	S	RHDS 30	186,15	STA RHDS 30	170,57
38	S	RHDS 38	*	STA RHDS 38	*

Taraje 1 bar. Para otras presiones de tarado estandar, consultar. / Setting 1 bar. For other standard spring pressures, consult us. / Tarage 1 bar. Pour d'autres pressions ressort standard, consultez-nous. / Per altre pressioni di taratura standard, consultare.

Antirretorno tubo - rosca BSP

Non-return valve flow towards male stud end
BSP cyl

Clapet antiretour unidir. à droite tube-mâle BSP

Valvola di ritegno a destra

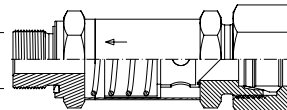

T.	S.	THREAD ROSCA	Part n° Referencia	€	Part N° STA Referencia STA	€
6	L	1/8" BSP	RHZL 6 R 1/8	23,27	STA RHZL 6 R 1/8	21,43
8	L	1/4" BSP	RHZL 8 R 1/4	25,03	STA RHZL 8 R 1/4	23,23
10	L	1/4" BSP	RHZL 10 R 1/4	29,24	STA RHZL 10 R 1/4	27,08
12	L	3/8" BSP	RHZL 12 R 3/8	34,52	STA RHZL 12 R 3/8	32,14
15	L	1/2" BSP	RHZL 15 R 1/2	38,89	STA RHZL 15 R 1/2	35,75
18	L	1/2" BSP	RHZL 18 R 1/2	54,58	STA RHZL 18 R 1/2	50,20
22	L	3/4" BSP	RHZL 22 R 3/4	86,75	STA RHZL 22 R 3/4	80,89
28	L	1" BSP	RHZL 28 R 1	100,84	STA RHZL 28 R 1	92,44
35	L	1"1/4 BSP	RHZL 35 R 1 1/4	*	STA RHZL 35 R 1 1/4	*
42	L	1"1/2 BSP	RHZL 42 R 1 1/2	*	STA RHZL 42 R 1 1/2	*
6	S	1/4" BSP	RHZS 6 R 1/4	23,59	STA RHZS 6 R 1/4	21,67
8	S	1/4" BSP	RHZS 8 R 1/4	23,69	STA RHZS 8 R 1/4	21,67
10	S	3/8" BSP	RHZS 10 R 3/8	29,34	STA RHZS 10 R 3/8	26,84
12	S	3/8" BSP	RHZS 12 R 3/8	34,28	STA RHZS 12 R 3/8	31,66
14	S	1/2" BSP	RHZS 14 R 1/2	40,47	STA RHZS 14 R 1/2	36,35
16	S	1/2" BSP	RHZS 16 R 1/2	52,31	STA RHZS 16 R 1/2	47,91
20	S	3/4" BSP	RHZS 20 R 3/4	64,88	STA RHZS 20 R 3/4	58,62
25	S	1" BSP	RHZS 25 R 1	99,10	STA RHZS 25 R 1	88,48
30	S	1"1/4 BSP	RHZS 30 R 1 1/4	*	STA RHZS 30 R 1 1/4	*
38	S	1"1/2 BSP	RHZS 38 R 1 1/2	*	STA RHZS 38 R 1 1/2	*

Taraje 1 bar. Para otras presiones de tarado estandar, consultar. / Setting 1 bar. For other standard spring pressures, consult us. / Tarage 1 bar. Pour d'autres pressions ressort standard, consultez-nous. / Per altre pressioni di taratura standard, consultare.

Antirretorno rosca BSP - tubo

Non-return valve flow from male stud end BSP cyl

Clapet antiretour unidir. à gauche mâle BSP-tube

Valvola di ritegno a sinistra

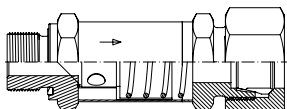

T.	S.	THREAD ROSCA	Part n° Referencia	€	Part N° STA Referencia STA	€
6	L	1/8" BSP	RHVL 6 R 1/8	23,15	STA RHVL 6 R 1/8	21,31
8	L	1/4" BSP	RHVL 8 R 1/4	25,51	STA RHVL 8 R 1/4	23,71
10	L	1/4" BSP	RHVL 10 R 1/4	29,24	STA RHVL 10 R 1/4	27,08
12	L	3/8" BSP	RHVL 12 R 3/8	35,48	STA RHVL 12 R 3/8	33,10
15	L	1/2" BSP	RHVL 15 R 1/2	40,22	STA RHVL 15 R 1/2	37,08
18	L	1/2" BSP	RHVL 18 R 1/2	56,50	STA RHVL 18 R 1/2	52,12
22	L	3/4" BSP	RHVL 22 R 3/4	84,10	STA RHVL 22 R 3/4	78,24
28	L	1" BSP	RHVL 28 R 1	97,89	STA RHVL 28 R 1	89,49
35	L	1"1/4 BSP	RHVL 35 R 1 1/4	258,47	STA RHVL 35 R 1 1/4	245,49
42	L	1"1/2 BSP	RHVL 42 R 1 1/2	265,36	STA RHVL 42 R 1 1/2	247,02
6	S	1/4" BSP	RHVS 6 R 1/4	26,00	STA RHVS 6 R 1/4	24,08
8	S	1/4" BSP	RHVS 8 R 1/4	26,10	STA RHVS 8 R 1/4	24,08
10	S	3/8" BSP	RHVS 10 R 3/8	29,34	STA RHVS 10 R 3/8	26,84
12	S	3/8" BSP	RHVS 12 R 3/8	34,76	STA RHVS 12 R 3/8	32,14
14	S	1/2" BSP	RHVS 14 R 1/2	41,80	STA RHVS 14 R 1/2	37,68
16	S	1/2" BSP	RHVS 16 R 1/2	51,59	STA RHVS 16 R 1/2	47,19
20	S	3/4" BSP	RHVS 20 R 3/4	65,48	STA RHVS 20 R 3/4	59,22
25	S	1" BSP	RHVS 25 R 1	99,94	STA RHVS 25 R 1	89,32
30	S	1"1/4 BSP	RHVS 30 R 1 1/4	*	STA RHVS 30 R 1 1/4	*
38	S	1"1/2 BSP	RHVS 38 R 1 1/2	*	STA RHVS 38 R 1 1/2	*

Taraje 1 bar. Para otras presiones de tarado estandar, consultar. / Setting 1 bar. For other standard spring pressures, consult us. / Tarage 1 bar. Pour d'autres pressions ressort standard, consultez-nous. / Per altre pressioni di taratura standard, consultare.

Mejoramos precios de la
válvula antirretorno tubo-tubo
Non-return valve tube-tube
improved price

TALLER DE LATIGUILLOS

HOSE WORKSHOP



Montaje de kits de primeros equipos / Assembly kits for Original Equipment Manufacturer



Para facilitar el trabajo de nuestros clientes ofrecemos unos kits para primeros equipos en los que incluimos todas las piezas necesarias para que puedas ensamblar tus propios equipos. Integra servicios de montaje, comerciales, tecnológicos y logísticos.

Dicsa offers kits for Original Equipment Manufacturer, including the necessary pieces for assembling your own equipments. These kits facilitate the work of our clients because assembly, comercial, technology and logistic services are integrated.

Racores JIC 37°

JIC 37° fittings
Raccords JIC 37°
Raccordi JIC 37°

T/Male Pipe

Pipe Fittings, DIN 2353
/ Flare fittings, JIC 37°

SAE Flanges

T/Male Clamps

Machines for
processing rigid pipes

Tuercas JIC 37°

JIC 37° Nuts

Écrous JIC 37°

Dado JIC 37°

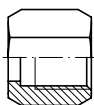

PIPE TUBO		THREAD ROSCA	Part n° Referencia	€
6	1/4	7/16" 20h UNF	S11006	0,55
8	5/16	1/2" 20h UNF	S11008	0,64
10	3/8	9/16" 18h UNF	S11010	0,70
12	1/2	3/4" 16h UNF	S11012	0,86
14-15-16	5/8	7/8" 14h UNF	S11016	1,47
18-20	-	1"1/16 12h UNF	S11020	2,60
-	3/4	1"1/16 12h UNF	S11020W	3,21
25	1	1"5/16 12h UNF	S11025	4,01
30-32	1 1/4	1"5/8 12h UNF	S11032	7,71
38	1 1/2	1"7/8 12h UNF	S11038	9,54
50	2	2" 1/2 12h UNF	S11050	14,73

Férulas JIC 37° (Tubo Métrico)

JIC 37° sleeves Metric tube

Férules JIC 37° pour tube Métrique

Bussola JIC 37° (tubo Metrico)

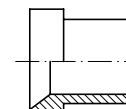

PIPE TUBO		Part n° Referencia	€
6		S12006	0,50
8		S12008	0,54
10		S12010	0,49
12		S12012	0,57
14		S12014	0,98
15		S12015	0,96
16		S12016	0,80
18		S12018	1,36
20		S12020	1,36
25		S12025	2,07
30		S12030	5,30
32		S12032	4,53
38		S12038	7,42

Tapón hembra JIC 37°

37° JIC Cap

Obtuteur femelle JIC 37° pour raccord

Tappo femmina girevole JIC 37°

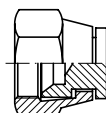

PIPE TUBO		THREAD ROSCA	Part n° Referencia	€
6	1/4	7/16" 20h UNF	S13006	1,55
8	5/16	1/2" 20h UNF	S13008	2,05
10	3/8	9/16" 18h UNF	S13010	2,32
12	1/2	3/4" 16h UNF	S13012	2,66
14-15-16	5/8	7/8" 14h UNF	S13016	3,70
18-20	3/4	1"1/16 12h UNF	S13020	5,42
25	1	1"5/16 12h UNF	S13025	9,29
30-32	1 1/4	1"5/8 12h UNF	S13032	15,74
38	1 1/2	1"7/8 12h UNF	S13038	30,79

Tapón macho JIC 37°

37° JIC Male plug

Bouchon mâle JIC 37°

Tappo maschio JIC 37°

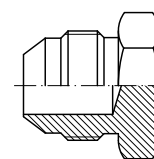

PIPE TUBO		THREAD ROSCA	Part n° Referencia	€
6	1/4	7/16" 20h UNF	S14006	1,27
8	5/16	1/2" 20h UNF	S14008	1,55
10	3/8	9/16" 18h UNF	S14010	1,50
12	1/2	3/4" 16h UNF	S14012	1,56
14-15-16	5/8	7/8" 14h UNF	S14016	1,85
18-20	3/4	1"1/16 12h UNF	S14020	3,37
25	1	1"5/16 12h UNF	S14025	4,73
30-32	1 1/4	1"5/8 12h UNF	S14032	8,17
38	1 1/2	1"7/8 12h UNF	S14038	28,07

Racor macho-macho JIC 37°

Straight union JIC 37°

Adapteur droit mâle JIC x mâle JIC

Niples di giunzione maschio-maschio JIC 37°

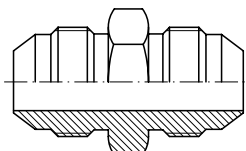

PIPE TUBO		THREAD ROSCA	Part n° Referencia	€
6	1/4	7/16" 20h UNF	S26006	1,33
8	5/16	1/2" 20h UNF	S26008	1,40
10	3/8	9/16" 18h UNF	S26010	1,45
12	1/2	3/4" 16h UNF	S26012	1,60
14-15-16	5/8	7/8" 14h UNF	S26016	2,49
18-20	3/4	1"1/16 12h UNF	S26020	3,80
25	1	1"5/16 12h UNF	S26025	6,10
30-32	1 1/4	1"5/8 12h UNF	S26032	10,86
38	1 1/2	1"7/8 12h UNF	S26038	18,74

Racor hembra giratoria-hembra giratoria JIC 37°

Straight swivel female JIC 37°

Adapteur femelle tournante JIC x femelle tournante JIC 37°

Niples femmina-femmina girevole JIC 37°

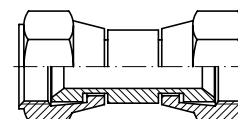

PIPE TUBO		THREAD ROSCA	Part n° Referencia	€
6	1/4	7/16" 20h UNF	S73006	4,24
8	5/16	1/2" 20h UNF	S73008	7,25
10	3/8	9/16" 18h UNF	S73010	5,43
12	1/2	3/4" 16h UNF	S73012	9,90
14-15-16	5/8	7/8" 14h UNF	S73016	11,27
18-20	3/4	1"1/16 12h UNF	S73020	11,59
25	1	1"5/16 12h UNF	S73025	18,15

Racores JIC 37°

JIC 37° fittings

Raccords JIC 37°

Raccordi JIC 37°

Racor macho JIC 37° - macho NPT

Straight adaptor male JIC-male NPT

Adapteur mâle JIC x mâle NPT

Niples di giunzione JIC 37°-NPT

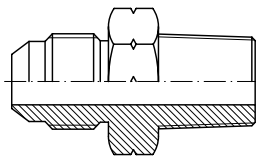

PIPE TUBO		THREAD ROSCA		Part n° Referencia	€
6	1/4	1/8" NPT	7/16" 20h UNF	S2000610	1,43
6	1/4	1/4" NPT	7/16" 20h UNF	S2000613	1,49
8	5/16	1/8" NPT	1/2" 20h UNF	S2000810	2,31
8	5/16	1/4" NPT	1/2" 20h UNF	S2000813	1,76
10	3/8	1/4" NPT	9/16" 18h UNF	S2001013	1,78
10	3/8	3/8" NPT	9/16" 18h UNF	S2001017	1,95
10	3/8	1/2" NPT	9/16" 18h UNF	S2001021	2,71
12	1/2	3/8" NPT	3/4" 16h UNF	S2001217	2,76
12	1/2	1/2" NPT	3/4" 16h UNF	S2001221	3,01
12	1/2	3/4" NPT	3/4" 16h UNF	S2001226	3,59
14-15-16	5/8	1/2" NPT	7/8" 14h UNF	S2001621	4,01
14-15-16	5/8	3/4" NPT	7/8" 14h UNF	S2001626	5,18
18-20	3/4	1/2" NPT	1"1/16 12h UNF	S2002021	4,54
18-20	3/4	3/4" NPT	1"1/16 12h UNF	S2002026	5,12
18-20	3/4	1" NPT	1"1/16 12h UNF	S2002033	6,62
25	1	3/4" NPT	1"5/16 12h UNF	S2002526	7,79
25	1	1" NPT	1"5/16 12h UNF	S2002533	7,53
32	1 1/4	1" NPT	1"5/8 12h UNF	S2003233	22,01
32	1 1/4	1"1/4 NPT	1"5/8 12h UNF	S2003242	15,66
38	1 1/2	1"1/4 NPT	1"7/8 12h UNF	S2003842	32,55
38	1 1/2	1"1/2 NPT	1"7/8 12h UNF	S2003848	28,56

Racor macho JIC 37° - macho BSP

Straight adaptor male JIC-male BSP

Adapteur mâle JIC x mâle gaz cyl équipé

Niples di giunzione JIC 37°-BSP

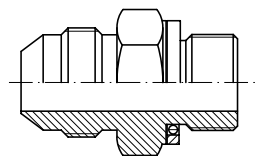

PIPE TUBO		THREAD ROSCA		Part n° Referencia	€
6	1/4	7/16" 20h UNF	1/8" BSP	S2300610	1,36
6	1/4	7/16" 20h UNF	1/4" BSP	S2300613	1,79
6	1/4	7/16" 20h UNF	3/8" BSP	S2300617	1,93
8	5/16	1/2" 20h UNF	1/4" BSP	S2300813	2,02
8	5/16	1/2" 20h UNF	3/8" BSP	S2300817	2,16
10	3/8	9/16" 18h UNF	1/4" BSP	S2301013	1,73
10	3/8	9/16" 18h UNF	3/8" BSP	S2301017	2,00
10	3/8	9/16" 18h UNF	1/2" BSP	S2301021	3,65
12	1/2	3/4" 16h UNF	1/4" BSP	S2301213	1,87
12	1/2	3/4" 16h UNF	3/8" BSP	S2301217	1,93
12	1/2	3/4" 16h UNF	1/2" BSP	S2301221	3,20
12	1/2	3/4" 16h UNF	3/4" BSP	S2301226	4,32
14-15-16	5/8	7/8" 14h UNF	3/8" BSP	S2301617	2,39
14-15-16	5/8	7/8" 14h UNF	1/2" BSP	S2301621	3,06
14-15-16	5/8	7/8" 14h UNF	3/4" BSP	S2301626	4,99
18-20	3/4	1"1/16 12h UNF	1/2" BSP	S2302021	4,09
18-20	3/4	1"1/16 12h UNF	3/4" BSP	S2302026	5,65
18-20	3/4	1"1/16 12h UNF	1" BSP	S2302033	7,81
25	1	1"5/16 12h UNF	3/4" BSP	S2302526	6,55
25	1	1"5/16 12h UNF	1" BSP	S2302533	7,89
25	1	1"5/16 12h UNF	1"1/4 BSP	S2302542	11,31
30-32	1 1/4	1"5/8 12h UNF	1"1/4 BSP	S2303242	12,28
38	1 1/2	1"7/8 12h UNF	1"1/4 BSP	S2303842	14,78
38	1 1/2	1"7/8 12h UNF	1"1/2 BSP	S2303848	25,00

Racor macho JIC 37° - macho BSPT

Straight adaptor male JIC-male BSPT

Adapteur mâle JIC x mâle gaz conique

Niples di giunzione JIC 37°-BSPT

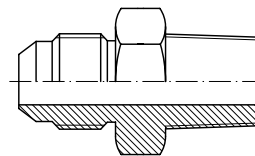

PIPE TUBO		THREAD ROSCA		Part n° Referencia	€
6	1/4	1/8" BSPT	7/16" 20h UNF	S2100610	0,93
6	1/4	1/4" BSPT	7/16" 20h UNF	S2100613	1,43
8	5/16	1/8" BSPT	1/2" 20h UNF	S2100810	1,15
8	5/16	1/4" BSPT	1/2" 20h UNF	S2100813	1,24
10	3/8	1/4" BSPT	9/16" 18h UNF	S2101013	1,53
10	3/8	3/8" BSPT	9/16" 18h UNF	S2101017	1,66
10	3/8	1/2" BSPT	9/16" 18h UNF	S2101021	2,65
12	1/2	1/4" BSPT	3/4" 16h UNF	S2101213	1,88
12	1/2	3/8" BSPT	3/4" 16h UNF	S2101217	2,23
12	1/2	1/2" BSPT	3/4" 16h UNF	S2101221	2,83
14-15-16	5/8	3/8" BSPT	7/8" 14h UNF	S2101617	3,17
14-15-16	5/8	1/2" BSPT	7/8" 14h UNF	S2101621	2,99
14-15-16	5/8	3/4" BSPT	7/8" 14h UNF	S2101626	3,14
18-20	3/4	1/2" BSPT	1"1/16 12h UNF	S2102021	3,64
18-20	3/4	3/4" BSPT	1"1/16 12h UNF	S2102026	4,39
25	1	3/4" BSPT	1"5/16 12h UNF	S2102526	6,79
25	1	1" BSPT	1"5/16 12h UNF	S2102533	6,39
30-32	1 1/4	1" BSPT	1"5/8 12h UNF	S2103233	21,59
30-32	1 1/4	1"1/4 BSPT	1"5/8 12h UNF	S2103242	20,45
38	1 1/2	1"1/2 BSPT	1"7/8 12h UNF	S2103848	28,31

Racor macho JIC 37° - macho UNF

Straight adaptor male JIC-male UNF

Adapteur mâle JIC x mâle UNF équipé

Niples di giunzione JIC 37°-UNF

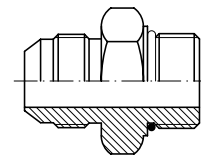

PIPE TUBO		THREAD ROSCA		Part n° Referencia	€
6	1/4	7/16" 20h JIC	7/16" 20h UNF	S2200611	1,20
6	1/4	7/16" 20h JIC	1/2" 20h UNF	S2200612	1,55
6	1/4	7/16" 20h JIC	9/16" 18h UNF	S2200614	1,49
8	5/16	1/2" 20h JIC	1/2" 20h UNF	S2200812	1,45
10	3/8	9/16" 18h JIC	9/16" 18h UNF	S2201014	1,71
10	3/8	9/16" 18h JIC	3/4" 16h UNF	S2201019	2,01
12	1/2	3/4" 16h JIC	3/4" 16h UNF	S2201219	2,65
12	1/2	3/4" 16h JIC	7/8" 14h UNF	S2201222	3,77
14-15-16	5/8	7/8" 14h JIC	7/8" 14h UNF	S2201622	3,36
14-15-16	5/8	7/8" 14h JIC	1"1/16 12h UNF	S2201627	5,69
14-15-16	5/8	7/8" 14h JIC	3/4" 16h UNF	S2201619	3,42
18-20	3/4	1"1/16 12h JIC	3/4" 16h UNF	S2202019	4,76
18-20	3/4	1"1/16 12h JIC	7/8" 14h UNF	S2202022	4,54
18-20	3/4	1"1/16 12h JIC	1"1/16 12h UNF	S2202027	5,61
18-20	3/4	1"1/16 12h JIC	1"5/16 12h UNF	S2202033	6,21
25	1	1"5/16 12h JIC	1"1/16 12h UNF	S2202527	9,91
25	1	1"5/16 12h JIC	1"5/16 12h UNF	S2202533	6,18
25	1	1"5/16 12h JIC	1"5/8 12h UNF	S2202541	27,23
30-32	1 1/4	1"5/8 12h JIC	1"5/8 12h UNF	S2203241	12,56
38	1 1/2	1"7/8 12h JIC	1"7/8 12h UNF	S2203848	33,36

Racores JIC 37°

JIC 37° fittings

Raccords JIC 37°

Raccordi JIC 37°

Racor pasatabiques JIC 37°

Straight bulkhead fitting JIC 37°

Union passe cloison droite mâle JIC x mâle JIC équipé

Niples passaparete JIC 37°

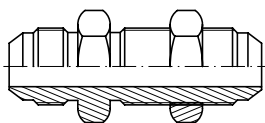

PIPE TUBO		THREAD ROSCA	Part nº Referencia	€
6	1/4	7/16" 20h UNF	S25006	2,56
8	5/16	1/2" 20h UNF	S25008	3,42
10	3/8	9/16" 18h UNF	S25010	3,50
12	1/2	3/4" 16h UNF	S25012	4,59
14-15-16	5/8	7/8" 14h UNF	S25016	5,12
18-20	3/4	1"1/16 12h UNF	S25020	8,67
25	1	1"5/16 12h UNF	S25025	10,10
30-32	1 1/4	1"5/8 12h UNF	S25032	19,87
38	1 1/2	1"7/8 12h UNF	S25038	48,73

Racor macho JIC 37° - macho Métrico

Metric adaptor male-male JIC 37°

Adapteur mâle JIC x mâle Métrique équipé

Niples di giunzione JIC 37°-Metrico

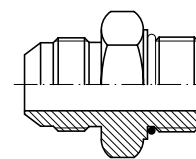

PIPE TUBO		THREAD ROSCA	Part nº Referencia	€	
6	1/4	7/16" 20h UNF	M10X1	S2400610	2,97
8	5/16	1/2" 20h UNF	M12X1.5	S2400812	3,13
10	3/8	9/16" 18h UNF	M14X1.5	S2401014	3,40
12	1/2	3/4" 16h UNF	M16X1.5	S2401216	3,36
12	1/2	3/4" 16h UNF	M18X1.5	S2401218	3,80
14-15-16	5/8	7/8" 14h UNF	M18X1.5	S2401418	4,53
14-15-16	5/8	7/8" 14h UNF	M22X1.5	S2401622	4,95
20	3/4	1"1/16 12h UNF	M18X1.5	S2402018	7,71
18-20	3/4	1"1/16 12h UNF	M22X1.5	S2402022	7,74
18-20	3/4	1"1/16 12h UNF	M27X2	S2402027	10,09
25	1	1"5/16 12h UNF	M33X2	S2402533	19,00
30-32	1 1/4	1"5/8 12h UNF	M42X2	S2403242	31,36

Racor macho BSP - hembra giratoria JIC 37°

Adaptor swivel female JIC-male BSP

Adapteur femelle tournante JIC x mâle gaz cyl équipé

Niples maschio-femmina BSP-JIC 37°

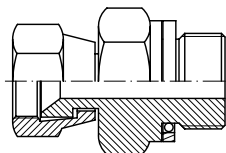

PIPE TUBO		THREAD ROSCA	Part nº Referencia	€	
6	1/4	M 1/8" BSP	F 7/16" 20F UNF	S1800610	3,70
8	5/16	M 1/4" BSP	F 1/2" 20F UNF	S1800813	4,64
8	5/16	M 3/8" BSP	F 1/2" 20F UNF	S1800817	5,12
10	3/8	M 1/4" BSP	F 9/16" 18F UNF	S1801013	5,59
10	3/8	M 3/8" BSP	F 9/16" 18F UNF	S1801017	6,88
12	1/2	M 3/8" BSP	F 3/4" 16F UNF	S1801217	7,31
14-15-16	5/8	M 1/2" BSP	F 7/8" 14F UNF	S1801621	9,89
18-20	3/4	M 3/4" BSP	F 1"1/16 12F UNF	S1802026	11,44
25	1	M 1" BSP	F 1"5/16 12F UNF	S1802533	16,50
30-32	1 1/4	M 1"1/4 BSP	F 1"5/8 12F UNF	S1803242	28,47
38	1 1/2	M 1"1/2 BSP	F 1"7/8 12F UNF	S1803848	69,70

Racor macho JIC 37° - hembra fija BSP

Adaptor male JIC 37°-fixed female BSP

Adapteur mâle JIC x femelle gaz cyl

Niples maschio-femmina JIC 37°-BSP

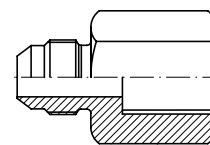

PIPE TUBO		THREAD ROSCA	Part nº Referencia	€	
6	1/4	M 7/16" 20h UNF	F 1/8" BSP	S2800610	5,40
6	1/4	M 7/16" 20h UNF	F 1/4" BSP	S2800613	5,40
8	5/16	M 1/2" 20h UNF	F 1/8" BSP	S2800810	6,01
8	5/16	M 1/2" 20h UNF	F 1/4" BSP	S2800813	6,01
10	3/8	M 9/16" 18h UNF	F 1/4" BSP	S2801013	5,55
10	3/8	M 9/16" 18h UNF	F 3/8" BSP	S2801017	6,01
12	1/2	M 3/4" 16h UNF	F 3/8" BSP	S2801217	6,01
12	1/2	M 3/4" 16h UNF	F 1/2" BSP	S2801221	7,42
14-15-16	5/8	M 7/8" 14h UNF	F 1/2" BSP	S2801621	7,27
18-20	3/4	M 1"1/16 12h UNF	F 1/2" BSP	S2802021	9,93
18-20	3/4	M 1"1/16 12h UNF	F 3/4" BSP	S2802026	10,05
25	1	M 1"5/16 12h UNF	F 1" BSP	S2802533	19,25
30-32	1 1/4	M 1"5/8 12h UNF	F 1"1/4 BSP	S2803242	30,02
38	1 1/2	M 1"7/8 12h UNF	F 1"1/2 BSP	S2803848	48,09

Racor unión macho-hembra fija JIC 37°

Reducer adaptor JIC male-JIC 37° fixed female

Reducteur mâle JIC x femelle fixe JIC 37°

Riduzione maschio-femmina fissa JIC 37°

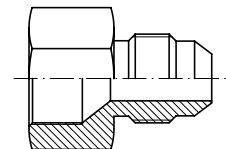

T.	THREAD ROSCA		Part nº Referencia	€	
10	6	F 7/16" 18F UNF	M 9/16" 20h UNF	S2900610	2,62
10	6	F 9/16" 18F UNF	M 7/16" 20h UNF	S2901006	5,25
12	6	F 3/4" 16F UNF	M 7/16" 20h UNF	S2901206	5,48
8	12	F 3/4" 16F UNF	M 1/2" 20h UNF	S2901208	6,87
12	10	F 3/4" 16F UNF	M 9/16" 18h UNF	S2901210	5,31
14-15-16	6	F 7/8" 14F UNF	M 7/16" 20h UNF	S2901606	7,66
14-15-16	10	F 7/8" 14F UNF	M 9/16" 18h UNF	S2901610	8,38
14-15-16	12	F 7/8" 14F UNF	M 3/4" 16h UNF	S2901612	6,53
18-20	6	F 1"1/16 12F UNF	M 7/16" 20h UNF	S2902006	8,90
18-20	12	F 1"1/16 12F UNF	M 3/4" 16h UNF	S2902012	8,38
25	18-20	F 1"5/16 12F UNF	M 1"1/16 12h UNF	S2902520	11,17
30-32	25	F 1"5/8 12F UNF	M 1"5/16 12h UNF	S2903225	20,62
38	30-32	F 1"7/8 12F UNF	M 1"5/8 12h UNF	S2903832	27,51

Racor macho BSPT - hembra giratoria JIC 37°

Adaptor male BSPT-swivel female JIC 37°

Adapteur femelle tournante JIC x mâle gaz conique

Niples maschio-femmina BSPT-JIC 37°

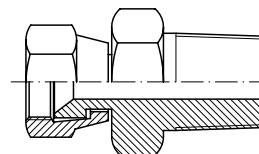

PIPE TUBO		THREAD ROSCA	Part nº Referencia	€	
6	1/4	M 1/4" BSPT	F 7/16" 20h UNF	S1500613	6,03
8	5/16	M 1/4" BSPT	F 1/2" 20h UNF	S1500813	7,00
10	3/8	M 1/4" BSPT	F 9/16" 18h UNF	S1501013	7,04
12	1/2	M 1/4" BSPT	F 3/4" 16h UNF	S1501213	8,68
12	1/2	M 3/8" BSPT	F 3/4" 16h UNF	S1501217	8,21
16	5/8	M 1/2" BSPT	F 7/8" 14h UNF	S1501621	11,77
20	3/4	M 1/2" BSPT	F 1"1/16 12h UNF	S1502021	13,31
20	3/4	M 3/4" BSPT	F 1"1/16 12h UNF	S1502026	13,61
25	1	M 3/4" BSPT	F 1"5/16 12h UNF	S1502526	27,33
25	1	M 1" BSPT	F 1"5/16 12h UNF	S1502533	26,18
32	1 1/4	M 1"1/4 BSPT	F 1"5/8 12h UNF	S1503242	39,76

Racores JIC 37°

JIC 37° fittings

Raccords JIC 37°

Raccordi JIC 37°

Adaptador hembra giratoria JIC - Macho BSP (60°)

Adaptor swivel female JIC 37° - BSP male 60°

Adapteur femelle tournante JIC x mâle BSP 60°

Nipples femmina girevole JIC 37° - maschio BSP 60°

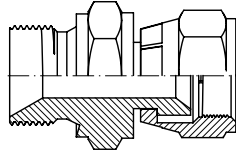

THREAD ROSCA		Part n° Referencia	€
M 1/4" BSP	F 7/16" UNF	S2150604	3,35
M 1/4" BSP	F 1/2" UNF	S2150804	3,60
M 1/4" BSP	F 9/16" UNF	S2151004	3,75
M 3/8" BSP	F 9/16" UNF	S2151006	4,37
M 1/2" BSP	F 9/16" UNF	S2151008	5,32
M 3/8" BSP	F 3/4" UNF	S2151206	4,57
M 1/2" BSP	F 3/4" UNF	S2151208	5,58
M 1/2" BSP	F 7/8" UNF	S2151608	5,88
M 3/4" BSP	F 1" 1/16 UNF	S2152012	7,57
M 1" BSP	F 1"5/16 UNF	S2152516	13,32

Adaptador Macho JIC - hembra giratoria JIC 37°

Adaptor male JIC - swivel female JIC

Adapteur mâle JIC x femelle tournante JIC

Nipples maschio JIC - femmina girevole JIC 37°

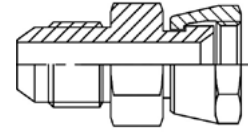

THREAD ROSCA	Part n° Referencia	€
7/16" 20h UNF	S7400606	3,10
1/2" 20h UNF	S7400808	3,73
9/16" 18h UNF	S7401010	3,47
3/4" 16h UNF	S7401212	4,93
7/8" 14h UNF	S7401616	6,28
1" 1/16 12 h UNF	S7402020	7,01
1" 5/16 12 h UNF	S7402525	10,47

Codo 90° macho - macho JIC 37°

90° Male elbow male JIC 37°-male JIC 37°

Adapteur coude 90° mâle JIC 37° x mâle JIC 37°

Adattatore a 90° maschio-maschio JIC 37°

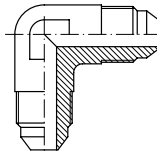

PIPE TUBO	THREAD ROSCA	Part n° Referencia	€	
6	1/4	7/16" 20h UNF	S50006	2,83
8	5/16	1/2" 20h UNF	S50008	4,02
10	3/8	9/16" 18h UNF	S50010	3,30
12	1/2	3/4" 16h UNF	S50012	4,57
14-15-16	5/8	7/8" 14h UNF	S50016	5,95
18-20	3/4	1" 1/16 12h UNF	S50020	10,27
25	1	1"5/16 12h UNF	S50025	13,84
30-32	1 1/4	1"5/8 12h UNF	S50032	33,14
38	1 1/2	1"7/8 12h UNF	S50038	45,79

Codo 90° pasatabiques JIC 37°

90° Bulkhead coupling male JIC 37°-male JIC 37°

Adapteur coude 90° passe cloison mâle JIC 37° x mâle JIC 37° équipé

Adattatore a 90° passaparete maschio-maschio JIC 37°

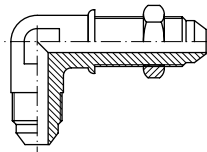

PIPE TUBO	THREAD ROSCA	Part n° Referencia	€	
6	6	7/16" 20h UNF	S65006	4,51
8	8	1/2" 20h UNF	S65008	4,22
10	10	9/16" 18h UNF	S65010	4,69
12	12	3/4" 16h UNF	S65012	6,18
14-15-16	14-15-16	7/8" 14h UNF	S65016	9,08
18-20	18-20	1" 1/16 12h UNF	S65020	15,00
25	25	1"5/16 12h UNF	S65025	28,24

Codo 90° macho JIC 37° - macho BSPT

90° Male elbow male JIC 37° -male BSPT

Adapteur coude 90° mâle JIC 37° x mâle gaz conique

Adattatore a 90° maschio-maschio JIC 37°-BSPT

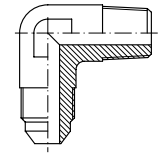

PIPE TUBO	THREAD ROSCA	Part n° Referencia	€		
6	1/4	7/16" 20h UNF	1/8" BSPT	S5500610	7,04
6	1/4	7/16" 20h UNF	1/4" BSPT	S5500613	7,11
8	5/16	1/2" 20h UNF	1/8" BSPT	S5500810	10,32
8	5/16	1/2" 20h UNF	1/4" BSPT	S5500813	6,54
10	3/8	9/16" 18h UNF	1/4" BSPT	S5501013	5,56
10	3/8	9/16" 18h UNF	3/8" BSPT	S5501017	11,80
10	3/8	9/16" 18h UNF	1/2" BSPT	S5501021	14,48
12	1/2	3/4" 16h UNF	1/4" BSPT	S5501213	11,38
12	1/2	3/4" 16h UNF	3/8" BSPT	S5501217	7,46
12	1/2	3/4" 16h UNF	1/2" BSPT	S5501221	9,82
14-15-16	5/8	7/8" 14h UNF	3/8" BSPT	S5501617	15,22
14-15-16	5/8	7/8" 14h UNF	1/2" BSPT	S5501621	9,02
14-15-16	5/8	7/8" 14h UNF	3/4" BSPT	S5501626	22,45
18-20	3/4	1" 1/16 12h UNF	1/2" BSPT	S5502021	19,33
18-20	3/4	1" 1/16 12h UNF	3/4" BSPT	S5502026	15,49
25	1	1"5/16 12h UNF	3/4" BSPT	S5502526	27,91
25	1	1"5/16 12h UNF	1" BSPT	S5502533	23,15
30-32	1 1/4	1"5/8 12h UNF	1" BSPT	S5503233	32,65
30-32	1 1/4	1"5/8 12h UNF	1" 1/4 BSPT	S5503242	33,64
38	1 1/2	1"7/8 12h UNF	1" 1/2 BSPT	S5503848	78,55

Racores JIC 37°

JIC 37° fittings

Raccords JIC 37°

Raccordi JIC 37°

Codo 90° macho JIC 37° - macho NPT

90° Male elbow male JIC 37°-male NPT

Adapteur coude 90° mâle JIC 37° x mâle NPT

Adattatore a 90° maschio-maschio JIC 37°-NPT

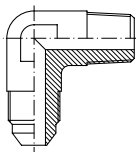

PIPE TUBO	THREAD ROSCA	Part n° Referencia	€		
6	1/4	7/16" 20h UNF	1/8" NPT	S5250610	4,51
6	1/4	7/16" 20h UNF	1/4" NPT	S5250613	4,82
8	5/16	1/2" 20h UNF	1/8" NPT	S5250810	5,55
8	5/16	1/2" 20h UNF	1/4" NPT	S5250813	6,15
10	3/8	9/16" 18h UNF	1/4" NPT	S5251013	3,69
10	3/8	9/16" 18h UNF	3/8" NPT	S5251017	4,54
10	3/8	9/16" 18h UNF	1/2" NPT	S5251021	10,23
12	1/2	3/4" 16h UNF	1/4" NPT	S5251213	5,67
12	1/2	3/4" 16h UNF	3/8" NPT	S5251217	5,93
12	1/2	3/4" 16h UNF	1/2" NPT	S5251221	6,71
14-15-16	5/8	7/8" 14h UNF	3/8" NPT	S5251617	10,21
14-15-16	5/8	7/8" 14h UNF	1/2" NPT	S5251621	10,91
14-15-16	5/8	7/8" 14h UNF	3/4" NPT	S5251626	16,77
18-20	3/4	1" 1/16 12h UNF	1/2" NPT	S5252021	11,60
18-20	3/4	1" 1/16 12h UNF	3/4" NPT	S5252026	10,66
25	1	1" 5/16 12h UNF	3/4" NPT	S5252526	21,59
25	1	1" 5/16 12h UNF	1" NPT	S5252533	21,64
30-32	1 1/4	1" 5/8 12h UNF	1" NPT	S5253233	34,92
30-32	1 1/4	1" 5/8 12h UNF	1" 1/4 NPT	S5253242	34,90
38	1 1/2	1" 7/8 12h UNF	1" 1/2 NPT	S5253848	58,15

Codo 90° macho - hembra giratoria JIC 37°

90° Elbow swivel female JIC 37°-male JIC 37°

Adapteur coude 90° mâle JIC 37° x femelle tournante JIC 37°

Adattatore a 90° maschio-femmina girevole JIC 37°

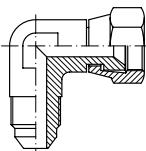

PIPE TUBO	THREAD ROSCA	Part n° Referencia	€	
6	1/4	7/16" 20h UNF	S67506	3,78
8	5/16	1/2" 20h UNF	S67508	4,99
10	3/8	9/16" 18h UNF	S67510	5,28
12	1/2	3/4" 16h UNF	S67512	7,44
14-15-16	5/8	7/8" 14h UNF	S67516	7,74
18-20	3/4	1" 1/16 12h UNF	S67520	9,26
25	1	1" 5/16 12h UNF	S67525	20,83
30-32	1 1/4	1" 5/8 12h UNF	S67532	56,26
38	1 1/2	1" 7/8 12h UNF	S67538	50,15

Codo 90° hembra giratoria JIC 37°- Macho NPT (60°)

90° Elbow swivel female JIC 37°-NPT male (60°)

Adapteur coude 90° femelle tournante JIC 37° x mâle NPT (60°)

Adattatore a 90° femmina girevole JIC 37°-maschio NPT (60°)

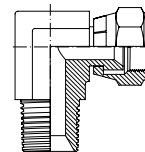

PIPE TUBO	THREAD ROSCA	Part n° Referencia	€		
6	1/4	F 7/16" 20h UNF	M 1/4" NPT	S5950604	4,50
8	5/16	F 1/2" 20h UNF	M 1/4" NPT	S5950804	5,57
10	3/8	F 9/16" 18h UNF	M 1/4" NPT	S5951004	5,65
10	3/8	F 9/16" 18h UNF	M 3/8" NPT	S5951006	5,65
12	1/2	3/4" 16h UNF	M 3/8" NPT	S5951206	7,77
12	1/2	3/4" 16h UNF	M 1/2" NPT	S5951208	7,86
14-15-16	5/8	7/8" 14h UNF	M 1/2" NPT	S5951608	8,35
18-20	3/4	1" 1/16 12 h UNF	M 3/4" NPT	S5952012	11,38
25	1	1" 5/16 12 h UNF	M 1" NPT	S5952516	22,01

Codo 90° hembra giratoria JIC 37°- hembra giratoria JIC 37°

90° Elbow swivel female JIC 37°-swivel female JIC 37°

Adapteur coude 90° femelle tournante JIC 37° x femelle tournante JIC 37°

Adattatore a 90° femmina girevole JIC 37°-femmina girevole JIC 37°

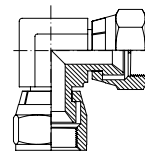

PIPE TUBO	THREAD ROSCA	Part n° Referencia	€
6	7/16" 20h UNF	S6650606	5,32
8	1/2" 20h UNF	S6650808	6,47
10	9/16" 18h UNF	S6651010	6,47
12	3/4" 16h UNF	S6651212	7,53
14-15-16	7/8" 14h UNF	S6651616	13,75
18-20	1" 1/16 12 h UNF	S6652020	23,41
25	1" 5/16 12 h UNF	S6652525	29,38

Codo 45° macho - hembra giratoria JIC 37°

45° Elbow male-swivel female JIC 37°

Adapteur coude 45° mâle JIC 37° x femelle tournante JIC 37°

Adattatore a 45° maschio-femmina girevole JIC 37°

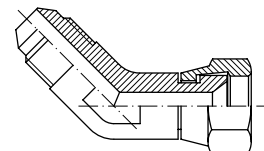

PIPE TUBO	THREAD ROSCA	Part n° Referencia	€	
6	1/4	7/16" 20h UNF	S69006	3,64
8	5/16	1/2" 20h UNF	S69008	5,90
10	3/8	9/16" 18h UNF	S69010	5,84
12	1/2	3/4" 16h UNF	S69012	5,86
14-15-16	5/8	7/8" 14h UNF	S69016	10,00
18-20	3/4	1" 1/16 12h UNF	S69020	12,87
25	1	1" 5/16 12h UNF	S69025	21,55

Racores JIC 37°

JIC 37° fittings

Raccords JIC 37°

Raccordi JIC 37°

Codo 90° macho JIC 37° - macho BSP orientable

90° Elbow male JIC 37°-BSP adjustable male

Adapteur orientable coude 90° mâle JIC 37° x mâle gaz cyl + o'ring équipé

Adattatore a 90° maschio-maschio orientabile JIC 37°-BSP

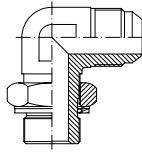

PIPE TUBO		THREAD ROSCA		Part n° Referencia	€
6	1/4	7/16" 20h UNF	1/8" BSP	S6000610	3,58
6	1/4	7/16" 20h UNF	1/4" BSP	S6000613	4,57
8	5/16	1/2" 20h UNF	1/8" BSP	S6000810	4,42
8	5/16	1/2" 20h UNF	1/4" BSP	S6000813	5,21
10	3/8	9/16" 18h UNF	1/4" BSP	S6001013	4,73
10	3/8	9/16" 18h UNF	3/8" BSP	S6001017	5,09
10	3/8	9/16" 18h UNF	1/2" BSP	S6001021	11,70
12	1/2	3/4" 16h UNF	3/4" BSP	S6001213	5,95
12	1/2	3/4" 16h UNF	3/8" BSP	S6001217	6,32
12	1/2	3/4" 16h UNF	1/2" BSP	S6001221	7,75
16	5/8	7/8" 14h UNF	3/8" BSP	S6001617	8,04
14-15-16	5/8	7/8" 14h UNF	1/2" BSP	S6001621	8,11
18-20	3/4	1"1/16 12h UNF	1/2" BSP	S6002021	11,23
18-20	3/4	1"1/16 12h UNF	3/4" BSP	S6002026	10,94
18-20	3/4	1"1/16 12h UNF	1" BSP	S6002033	18,97
25	1	1"5/16 12h UNF	3/4" BSP	S6002526	18,28
25	1	1"5/16 12h UNF	1" BSP	S6002533	20,31
30-32	1 1/4	1"5/8 12h UNF	1" BSP	S6003233	26,41
30-32	1 1/4	1"5/8 12h UNF	1"1/4 BSP	S6003242	34,37
38	1 1/2	1"7/8 12h UNF	1"1/4 BSP	S6003842	65,46
38	1 1/2	1"7/8 12h UNF	1"1/2 BSP	S6003848	77,88

Codo 45° macho JIC 37° - macho BSP orientable

45° Elbow male JIC 37°-BSP adjustable male

Adapteur coude 45° mâle JIC 37° x mâle gaz cyl + o'ring équipé

Adattatore a 45° maschio JIC 37°-maschio BSP orientabile

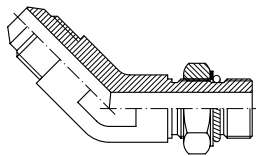

PIPE TUBO		THREAD ROSCA		Part n° Referencia	€
8	5/16	1/2" 20h UNF	1/4" BSP	S6150813	4,71
10	3/8	9/16" 18h UNF	1/4" BSP	S6151013	5,43
12	1/2	3/4" 16h UNF	3/8" BSP	S6151217	6,85
12	1/2	3/4" 16h UNF	1/2" BSP	S6151221	7,59
14-15-16	5/8	7/8" 14h UNF	1/2" BSP	S6151621	8,11
18-20	3/4	1"1/16 12h UNF	1/2" BSP	S6152021	11,78
18-20	3/4	1"1/16 12h UNF	3/4" BSP	S6152026	11,77
25	1	1"5/16 12h UNF	1" BSP	S6152533	18,84

Codo 90° macho JIC 37° - macho UNF orientable

90° Elbow male JIC 37°-unf adjustable male

Adapteur orientable coude 90° mâle JIC 37° x mâle UNF + o'ring équipé

Adattatore a 90° maschio-maschio orientabile JIC 37°-UNF

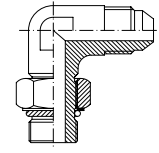

PIPE TUBO		THREAD ROSCA		Part n° Referencia	€
6	1/4	7/16" 20h JIC	7/16" 20h UNF	S5750611	3,87
6	1/4	7/16" 20h JIC	1/2" 20h UNF	S5750612	7,86
8	5/16	1/2" 20h JIC	1/2" 20h UNF	S5750812	4,76
10	3/8	9/16" 18h JIC	9/16" 18h UNF	S5751014	6,00
10	3/8	9/16" 18h JIC	3/4" 16h UNF	S5751019	6,73
12	1/2	3/4" 16h JIC	3/4" 16h UNF	S5751219	5,65
12	1/2	3/4" 16h JIC	7/8" 14h UNF	S5751222	12,59
14-15-16	5/8	7/8" 14h JIC	3/4" 16h UNF	S5751619	13,44
14-15-16	5/8	7/8" 14h JIC	7/8" 14h UNF	S5751622	11,18
18-20	3/4	1"1/16 12h JIC	7/8" 14h UNF	S5752022	15,96
18-20	3/4	1"1/16 12h JIC	1"1/16 12h UNF	S5752027	13,25
25	1	1"5/16 12h JIC	1"1/16 12h UNF	S5752527	27,42
25	1	1"5/16 12h JIC	1"5/16 12h UNF	S5752533	22,53
30-32	1 1/4	1"5/8 12h JIC	1"5/8 12h UNF	S5753241	44,67
38	1 1/2	1"7/8 12h JIC	1"7/8 12h UNF	S5753848	68,31

Codo 90° macho JIC 37° - macho métrico orientable

90° Elbow male JIC 37°-Metric adjustable male

Adapteur orientable coude 90° mâle JIC 37° x mâle Métrique + o'ring équipé

Adattatore a 90° maschio-maschio orientabile JIC 37° Metrico

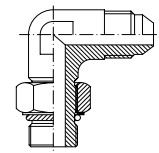

PIPE TUBO		THREAD ROSCA		Part n° Referencia	€
6	1/4	7/16" 20h UNF	M10x1	S6250610	4,14
8	5/16	1/2" 20h UNF	M12x1,5	S6250812	9,74
10	3/8	9/16" 18h UNF	M14x1,5	S6251014	5,59
12	1/2	3/4" 16h UNF	M16x1,5	S6251216	10,98
12	1/2	3/4" 16h UNF	M18x1,5	S6251218	6,78
14-15-16	5/8	7/8" 14h UNF	M18x1,5	S6251618	12,57
14-15-16	5/8	7/8" 14h UNF	M22x1,5	S6251622	10,46
18-20	3/4	1"1/16 12h UNF	M22x1,5	S6252022	14,89
18-20	3/4	1"1/16 12h UNF	M27x2	S6252027	19,61
25	1	1"5/16 12h UNF	M33x2	S6252533	22,67

Codo 45° macho JIC 37° - macho UNF orientable

45° Elbow male JIC 37°-UNF adjustable male

Adapteur coude 45° mâle JIC 37° x mâle gaz UNF + o'ring équipé

Adattatore a 45° maschio JIC 37°-maschio UNF orientabile

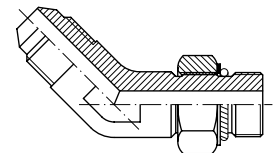

PIPE TUBO		THREAD ROSCA		Part n° Referencia	€
6	1/4	7/16" 20h JIC	7/16" 20h UNF	S7750611	3,11
8	5/16	1/2" 20h JIC	1/2" 20h UNF	S7750812	3,63
10	3/8	9/16" 18h JIC	9/16" 18h UNF	S7751014	3,63
12	1/2	3/4" 16h JIC	3/4" 16h UNF	S7751219	4,97
14-15-16	5/8	7/8" 14h JIC	7/8" 14h UNF	S7751622	7,04
18-20	3/4	1"1/16 12h JIC	1"1/16 12h UNF	S7752027	11,40
25	1	1"5/16 12h JIC	1"5/16 12h UNF	S7752533	16,58

Racores JIC 37°

JIC 37° fittings

Raccords JIC 37°

Raccordi JIC 37°

Tes macho-macho-macho JIC 37°

Union Tee male JIC 37°

Tés égaux mâle JIC 37°

Adattatore a T maschio JIC 37°

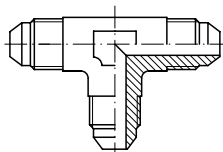

PIPE TUBO		THREAD ROSCA	Part nº Referencia	€
6	1/4	7/16" 20h UNF	S50506	4,32
8	5/16	1/2" 20h UNF	S50508	4,47
10	3/8	9/16" 18h UNF	S50510	5,28
12	1/2	3/4" 16h UNF	S50512	8,04
14-15-16	5/8	7/8" 14h UNF	S50516	9,67
18-20	3/4	1" 1/16 12h UNF	S50520	11,83
25	1	1" 5/16 12h UNF	S50525	18,53
30-32	1 1/4	1" 5/8 12h UNF	S50532	45,85
38	1 1/2	1" 7/8 12h UNF	S50538	126,69

Tes macho-macho-hembra giratoria JIC 37°

Swivel barrel tee male JIC 37°-male JIC 37°-swivel female JIC 37°

Tés égaux tournantes JIC 37° au latéral

Adattatore a T maschio-maschio-femmina girevole JIC 37°

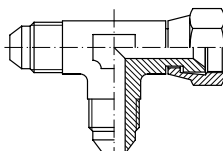

PIPE TUBO		THREAD ROSCA	Part nº Referencia	€
6	1/4	7/16" 20h UNF	S68006	5,95
8	5/16	1/2" 20h UNF	S68008	6,10
10	3/8	9/16" 18h UNF	S68010	5,65
12	1/2	3/4" 16h UNF	S68012	8,62
14-15-16	5/8	7/8" 14h UNF	S68016	10,17
18-20	3/4	1" 1/16 12h UNF	S68020	14,69
25	1	1" 5/16 12h UNF	S68025	25,89
30-32	1 1/4	1" 5/8 12h UNF	S68032	67,72
38	1 1/2	1" 7/8 12h UNF	S68038	101,13

Tes macho-hembra giratoria-macho JIC 37°

Swivel brunch tee male JIC 37°-swivel female JIC 37°-male JIC 37°

Tés égaux tournantes JIC 37° au centre

Adattatore a T maschio-femmina girevole-maschio JIC 37°

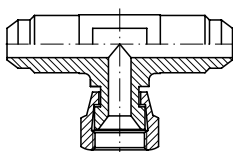

PIPE TUBO		THREAD ROSCA	Part nº Referencia	€
6	1/4	7/16" 20h UNF	S68506	6,20
8	5/16	1/2" 20h UNF	S68508	6,10
10	3/8	9/16" 18h UNF	S68510	5,65
12	1/2	3/4" 16h UNF	S68512	9,61
14-15-16	5/8	7/8" 14h UNF	S68516	11,71
18-20	3/4	1" 1/16 12h UNF	S68520	13,62
25	1	1" 5/16 12h UNF	S68525	40,35
30-32	1 1/4	1" 5/8 12h UNF	S68532	66,41
38	1 1/2	1" 7/8 12h UNF	S68538	99,32

Te H.G. JIC 37° - H.G. JIC 37° - H.G. JIC 37°

Tee swivel female JIC 37° - swivel female JIC 37° - swivel female JIC 37°

Té femelle tournante JIC - femelle tournante JIC - femelle tournante JIC

Raccordo a T JIC 37° (F-F-Orientabile)

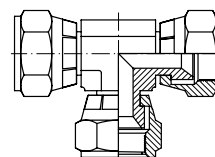

PIPE TUBO		THREAD ROSCA	Part nº Referencia	€
6	1/4	7/16" 20h UNF	S6700606	12,69
8	5/16	1/2" 20h UNF	S6700808	15,39
10	3/8	9/16" 18h UNF	S6701010	15,39
12	1/2	3/4" 16h UNF	S6701212	19,23
14-15-16	5/8	7/8" 14h UNF	S6701616	26,76
18-20	3/4	1" 1/16 12 h UNF	S6702020	33,64
25	1	1" 5/16 12 h UNF	S6702525	56,06

Te Macho JIC 37° - Macho BSPT (60°) - Macho JIC 37°

Brunch tee male JIC 37°-BSPT male 60°-male JIC 37°

Té mâle JIC 37° - mâle BSPT 60° - mâle JIC 37°

Raccordo a T JIC 37° orientabile centrale BSPT (M-M orientabile-M)

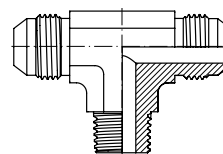

PIPE TUBO		THREAD ROSCA		Part nº Referencia	€
6	1/4	7/16" 20h UNF	1/4" BSPT	S6810604	5,57
8	5/16	1/2" 20h UNF	1/4" BSPT	S6810804	7,77
10	3/8	9/16" 18h UNF	1/4" BSPT	S6811004	6,14
10	3/8	9/16" 18h UNF	3/8" BSPT	S6811006	7,45
12	1/2	3/4" 16h UNF	3/8" BSPT	S6811206	9,98
12	1/2	3/4" 16h UNF	1/2" BSPT	S6811208	10,48
14-15-16	5/8	7/8" 14h UNF	1/2" BSPT	S6811608	11,05
18-20	3/4	1" 1/16 12 h UNF	3/4" BSPT	S6812012	14,57
25	1	1" 5/16 12 h UNF	1" BSPT	S6812516	27,42

Te Macho JIC 37° - Macho NPT (60°) - Macho JIC 37°

Brunch tee male JIC 37°-NPT male 60°-male JIC 37°

Té mâle JIC 37° - mâle NPT 60° - mâle JIC 37°

Raccordo a T JIC 37° orientabile centrale NPT (M-M orientabile-M)

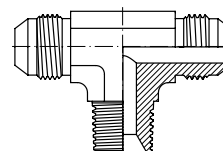

PIPE TUBO		THREAD ROSCA		Part nº Referencia	€
6	1/4	7/16" 20h UNF	1/4" NPT	S6950604	4,67
8	5/16	1/2" 20h UNF	1/4" NPT	S6950804	5,07
10	3/8	9/16" 18h UNF	1/4" NPT	S6951004	5,65
10	3/8	9/16" 18h UNF	3/8" NPT	S6951006	7,12
12	1/2	3/4" 16h UNF	3/8" NPT	S6951206	7,61
12	1/2	3/4" 16h UNF	1/2" NPT	S6951208	8,84
14-15-16	5/8	7/8" 14h UNF	1/2" NPT	S6951608	11,05
18-20	3/4	1" 1/16 12 h UNF	3/4" NPT	S6952012	14,49
25	1	1" 5/16 12 h UNF	1" NPT	S6952516	27,42

Racores JIC 37°

JIC 37° fittings

Raccords JIC 37°

Raccordi JIC 37°

Te macho JIC37° - macho orientable BSP - macho JIC37°

Tee male JIC 37°-BSP adjustable brunch male-male JIC 37°

Té mâle JIC 37° - mâle orientable BSP - mâle JIC 37°

Raccordo a T JIC 37° orientabile centrale BSP (M-M orientabile-M)

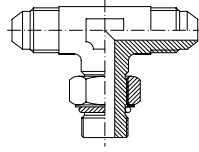

PIPE TUBO		THREAD ROSCA		Part n° Referencia	€
6	1/4	7/16" 20h UNF	1/4" BSP	S6100613	5,94
8	5/16	1/2" 20h UNF	1/4" BSP	S6100813	9,60
10	3/8	9/16" 18h UNF	1/4" BSP	S6101013	6,03
12	1/2	3/4" 16h UNF	3/8" BSP	S6101217	8,04
14-15-16	5/8	7/8" 14h UNF	1/2" BSP	S6101621	13,02
18-20	3/4	1"1/16 12h UNF	3/4" BSP	S6102026	23,68
25	1	1"5/16 12h UNF	1" BSP	S6102533	27,26
30-32	1 1/4	1"5/8 12h UNF	1"1/4 BSP	S6103242	76,07

Te macho JIC 37° - macho orientable UNF-macho JIC37°

Tee male JIC 37°-adjustable brunch UNF-male JIC 37°

Té mâle JIC 37° - mâle orientable UNF - mâle JIC 37°

Raccordo a T JIC 37° orientabile centrale UNF (M-M orientabile-M)

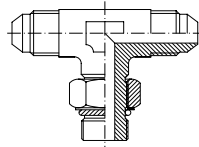

PIPE TUBO		THREAD ROSCA		Part n° Referencia	€
6	1/4	7/16" 20h UNF		S5850611	11,25
8	5/16	1/2" 20h UNF		S5850812	15,05
10	3/8	9/16" 18h UNF		S5851014	15,37
12	1/2	3/4" 16h UNF		S5851219	15,15
14-15-16	5/8	7/8" 14h UNF		S5851622	22,85
18-20	3/4	1"1/16 12h UNF		S5852027	30,17
25	1	1"5/16 12h UNF		S5852533	45,21

Te macho JIC 37° - macho orientable métrico-macho JIC37°

Tee male JIC 37°-metric adjustable brunch male-male JIC 37°

Té mâle JIC 37° - mâle orientable Métrique - mâle JIC 37°

Raccordo a T JIC 37° orientabile centrale Metrico (M-M orientabile-M)

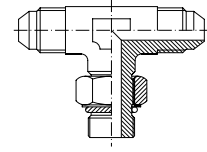

PIPE TUBO		THREAD ROSCA		Part n° Referencia	€
8	5/16	1/2" JIC	M12X1.5	S6350812	13,81
10	3/8	9/16" JIC	M14X1.5	S6351014	11,92
12	1/2	3/4" JIC	M18X1.5	S6351218	16,26
14-15-16	5/8	7/8" JIC	M18X1.5	S6351618	25,33
14-15-16	5/8	7/8" JIC	M22X1.5	S6351622	25,33
18-20	3/4	1"1/16 JIC	M27X2	S6352027	31,78
25	1	1"5/16 JIC	M33X2	S6352533	41,52

Te macho JIC 37°- macho JIC37°- macho orientable BSP

Tee male JIC 37°-male JIC 37°-male BSP adjustable barrel

Té mâle JIC 37° - mâle JIC 37° - mâle orientable BSP

Raccordo a T JIC 37° orientabile laterale BSP (M-M-M orientabile)

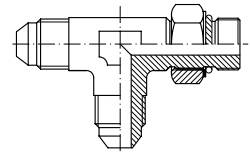

PIPE TUBO		THREAD ROSCA		Part n° Referencia	€
8	5/16	1/2" 20h UNF	1/4" BSP	S6050813	5,30
10	3/8	9/16" 18h UNF	1/4" BSP	S6051013	8,70
12	1/2	3/4" 16h UNF	3/8" BSP	S6051217	7,74
14-15-16	5/8	7/8" 14h UNF	1/2" BSP	S6051621	11,09
18-20	3/4	1"1/16 12h UNF	3/4" BSP	S6052026	21,38
25	1	1"5/16 12h UNF	1" BSP	S6052533	36,57
30-32	1 1/4	1"5/8 12h UNF	1"1/4 BSP	S6053242	61,87
38	1 1/2	1"7/8 12h UNF	1"1/2 BSP	S6053848	82,44

Te macho JIC 37° - macho JIC37°- macho orientable UNF

Tee male JIC 37°-male JIC 37°- adjustable barrel UNF

Té mâle JIC 37° - mâle JIC 37° - mâle orientable UNF

Raccordo a T JIC 37° orientabile laterale UNF (M-M-M orientabile)

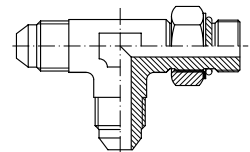

PIPE TUBO		THREAD ROSCA		Part n° Referencia	€
6	1/4	7/16" JIC	7/16" UNF	S5800611	17,80
8	5/16	1/2" JIC	1/2" UNF	S5800812	17,80
10	3/8	9/16" JIC	9/16" UNF	S5801014	10,88
16	5/8	7/8" JIC	7/8" UNF	S5801622	21,44
20	3/4	1"1/16 JIC	1"1/16 UNF	S5802027	33,14
25	1	1"5/16 JIC	1"5/16 UNF	S5802533	49,33



FÁBRICA FACTORY

FABRICACIÓN 4.0: INVERTIMOS EN INNOVACIÓN PARA REINVENTAR EL PROCESO DE FABRICACIÓN

4.0 SMART MANUFACTURING: WE REINVENTED MANUFACTURING PROCEDURES THANKS TO INNOVATIVE THINKING



SOMOS FABRICANTES

DICSA posee la maquinaria industrial más novedosa e innovadora del sector, resultado de la gran inversión realizada en los últimos años. Con un exhaustivo control de cada fase de nuestros productos se ha logrado un aumento de más del 40% de la producción en el último lustro, sin dejar de garantizar siempre una calidad óptima.

Además, poseemos un sistema interno de control de calidad de alta exigencia, que nos permite tener un registro de trazabilidad desde la salida de la materia prima de las instalaciones de los proveedores hasta la llegada del producto final a su destinatario, garantizando un producto acorde siempre a las exigencias del mercado y del cliente. Incluso nuestra línea de productos ha sido auditada y aprobada por el sector más exigente, el sector automovilístico.

WE ARE MANUFACTURERS

DICSA has the most innovative industrial equipment in the sector, as a result of the ongoing investment made in recent years. We have achieved an increase of more than 40% of the production in the last five years, whilst ensuring an optimum quality, applying an exhaustive control at each stage of production.

In addition, we have an internal quality control system, which allows us to have a traceability record from the raw materials leave the supplier's factories until the arrival of the final product to our clients, whilst ensuring a product according to market and customer demands. Our production line has been audited and approved by the most demanding sector: the automotive sector.



Alta rapidez de mecanizado
High speed machining



Máquina Transfer de alta productividad
Highly productivity Transfer machine



Tornos tipo suizo CNC
CNC Swiss Type Automatic Lathes



Curvadora automática
Automatic bending machine



Centro de limpieza
Clean up center



Máquina semi-automática de montaje
Semi-automatic assembling machine



CNC Robotizado
Robotic CNC



Máquina de corte computarizada
Computerized cutting machine

Bridas SAE

SAE Flanges

Brides de fixation SAE

Flangia SAE

Bridas SAE

SAE Flanges

Brides de fixation SAE

Flange SAE

3

Bridas SAE

SAE Flanges
Brides de fixation SAE
Flange SAE

- Bridas Roscadas / Threaded flanges / Brides taraudées / Flangia filettate | 246

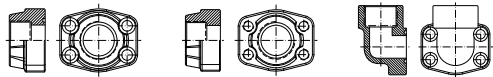

BBRG

BCRG

B90RG

- Bridas soldables tubo gas / Welding flanges for gas tube / Brides à souder pour tube gaz / Flangia a saldare per tubo gas | 247

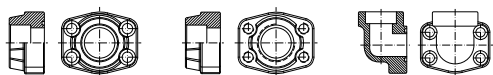

BBSG

BCSG

B90SG

- Bridas soldables tubo métrico / Welding flanges for metric tube / Brides à souder pour tube métrique / Flangia a saldare per tubo Metrico | 248

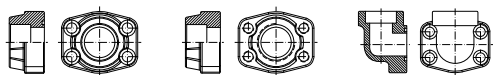

BBSM

BCSM

B90SM

- Bridas soldables macho / Male welding flanges / Brides à souder mâle / Flangia a saldare maschio | 249

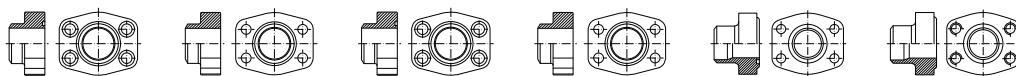

BMSG

BMSG

BMSM

BCMSM

BMSLM

BCMSLM

- Accesorios bridas / Flange accessories / Accessoires pour brides / Accessori flangia | 251



TBSAE

JBR

JUNTAS

- Bridas roscadas macho / Male threaded flanges / Brides taraudées mâle / Flangia filettate maschio | 252

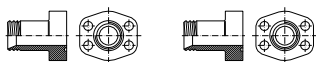

BMRG

BMRM

- Bridas ciegas / Blind flanges / Brides avec obturateur fermé / Flangia cieche | 252

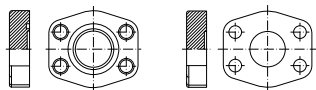

BBC

BCC

- Bridas para flexibles / SAE Flanges for hoses / Brides SAE pour flexibles / Flangia SAE per tubi flessibili | 253

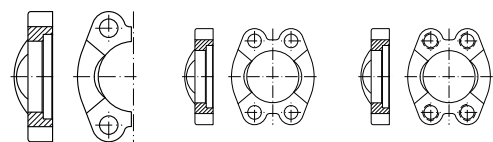

BBP

BBE

BCE

Bridas SAE

SAE Flanges
Brides de fixation SAE
Flange SAE

- Conos soldar /Welding adaptors for flanges /Collets à souder /Codoli a saldare

| 254

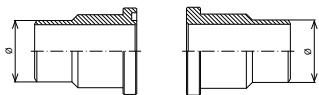

BSM31/61

BSM30/60

- Bridas Cetop /Cetop flanges /Brides Cetop /Flangia Cetop

| 254

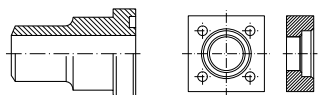

BCTS

BCT

Bridas SAE

SAE Flanges
Brides de fixation SAE
Flange SAE

Brida roscada hembra BSP

BSP Female threaded flange

Bride taraudée femelle BSP

Flangia filettata femmina BSP

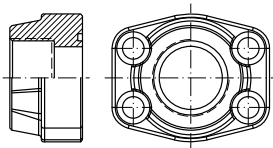

SERIE	THREAD ROSCA	SIZE TAMAÑO	Part nº Referencia	€
3000 PSI	1/2" BSP	1/2"	BBRG30808	13,45
3000 PSI	3/8" BSP	1/2"	BBRG30806	13,45
3000 PSI	3/4" BSP	3/4"	BBRG31212	15,33
3000 PSI	1/2" BSP	3/4"	BBRG31208	15,33
3000 PSI	1" BSP	1"	BBRG31616	17,75
3000 PSI	3/4" BSP	1"	BBRG31612	17,75
3000 PSI	1"1/4 BSP	1"1/4	BBRG32020	22,14
3000 PSI	1" BSP	1"1/4	BBRG32016	22,14
3000 PSI	1"1/2 BSP	1"1/2	BBRG32424	25,72
3000 PSI	1"1/4 BSP	1"1/2	BBRG32420	29,12
3000 PSI	2" BSP	2"	BBRG33232	36,10
3000 PSI	1"1/2 BSP	2"	BBRG33224	29,36
3000 PSI	2"1/2 BSP	2"1/2	BBRG34040	49,21
3000 PSI	2" BSP	2"1/2	BBRG34032	49,21
3000 PSI	2"1/2 BSP	3"	BBRG34840	48,82
3000 PSI	3" BSP	3"	BBRG34848	44,65
3000 PSI	3"1/2 BSP	3"1/2	BBRG35656	96,87
3000 PSI	3" BSP	3"1/2	BBRG35648	91,64
3000 PSI	4" BSP	4"	BBRG36464	77,79
3000 PSI	3"1/2 BSP	4"	BBRG36456	99,33
6000 PSI	1/2" BSP	1/2"	BBRG60808	14,14
6000 PSI	3/8" BSP	1/2"	BBRG60806	14,14
6000 PSI	3/4" BSP	3/4"	BBRG61212	21,09
6000 PSI	1/2" BSP	3/4"	BBRG61208	21,09
6000 PSI	1" BSP	1"	BBRG61616	25,72
6000 PSI	3/4" BSP	1"	BBRG61612	25,72
6000 PSI	1"1/4 BSP	1"1/4	BBRG62020	36,69
6000 PSI	1" BSP	1"1/4	BBRG62016	36,69
6000 PSI	1"1/4 BSP	1"1/2	BBRG62420	61,10
6000 PSI	1"1/2 BSP	1"1/2	BBRG62424	61,10
6000 PSI	2" BSP	2"	BBRG63232	88,37
6000 PSI	1"1/2 BSP	2"	BBRG63224	88,37

Contrabrida roscada hembra BSP

BSP Female threaded counter-flange

Contre-bride taraudée femelle BSP

Controflangia filettata femmina BSP

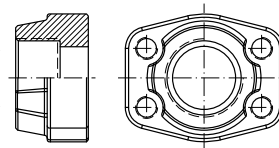

SERIE	THREAD ROSCA	SIZE TAMAÑO	Part nº Referencia	€
3000 PSI	1/2" BSP	1/2"	BCRG30808	13,45
3000 PSI	3/8" BSP	1/2"	BCRG30806	15,51
3000 PSI	3/4" BSP	3/4"	BCRG31212	15,33
3000 PSI	1/2" BSP	3/4"	BCRG31208	15,22
3000 PSI	1" BSP	1"	BCRG31616	17,66
3000 PSI	3/4" BSP	1"	BCRG31612	17,61
3000 PSI	1"1/4 BSP	1"1/4	BCRG32020	23,40
3000 PSI	1" BSP	1"1/4	BCRG32016	23,64
3000 PSI	1"1/2 BSP	1"1/2	BCRG32424	27,04
3000 PSI	1"1/4 BSP	1"1/2	BCRG32420	38,41
3000 PSI	2" BSP	2"	BCRG33232	30,51
3000 PSI	1"1/2 BSP	2"	BCRG33224	33,91
3000 PSI	2"1/2 BSP	2"1/2	BCRG34040	48,90
3000 PSI	2" BSP	2"1/2	BCRG34032	53,40
3000 PSI	3" BSP	3"	BCRG34848	58,90
3000 PSI	2"1/2 BSP	3"	BCRG34840	64,40
3000 PSI	3"1/2 BSP	3"1/2	BCRG35656	83,92
3000 PSI	3" BSP	3"1/2	BCRG35648	69,45
3000 PSI	4" BSP	4"	BCRG36464	68,83
3000 PSI	3"1/2 BSP	4"	BCRG36456	75,24
6000 PSI	1/2" BSP	1/2"	BCRG60808	14,14
6000 PSI	3/8" BSP	1/2"	BCRG60806	14,14
6000 PSI	3/4" BSP	3/4"	BCRG61212	21,09
6000 PSI	1/2" BSP	3/4"	BCRG61208	21,09
6000 PSI	1" BSP	1"	BCRG61616	25,72
6000 PSI	3/4" BSP	1"	BCRG61612	24,26
6000 PSI	1"1/4 BSP	1"1/4	BCRG62020	36,69
6000 PSI	1" BSP	1"1/4	BCRG62016	33,91
6000 PSI	1"1/2 BSP	1"1/2	BCRG62424	61,10
6000 PSI	1"1/4 BSP	1"1/2	BCRG62420	48,82
6000 PSI	2" BSP	2"	BCRG63232	88,37
6000 PSI	1"1/2 BSP	2"	BCRG63224	64,19

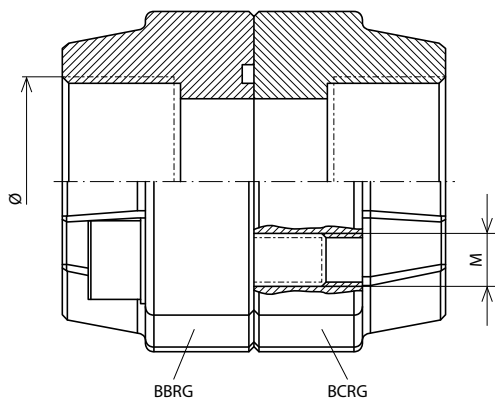

Brida codo 90° roscada hembra BSP

90° BSP female threaded flange

Bride 90° taraudée femelle BSP

Flangia a 90° filettata femmina BSP

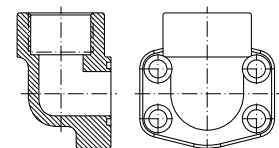

SERIE	THREAD ROSCA	SIZE TAMAÑO	Part nº Referencia	€
3000 PSI	1/2" BSP	1/2"	B90RG30808	30,82
3000 PSI	3/8" BSP	1/2"	B90RG30806	32,75
3000 PSI	3/4" BSP	3/4"	B90RG31212	35,46
3000 PSI	1" BSP	1"	B90RG31616	37,93
3000 PSI	1"1/4 BSP	1"1/4	B90RG32020	44,26
3000 PSI	1"1/2 BSP	1"1/2	B90RG32424	56,55
3000 PSI	2" BSP	2"	B90RG33232	68,37
6000 PSI	1/2" BSP	1/2"	B90RG60808	35,92
6000 PSI	3/8" BSP	1/2"	B90RG60806	35,92
6000 PSI	3/4" BSP	3/4"	B90RG61212	38,16
6000 PSI	1" BSP	1"	B90RG61616	43,88
6000 PSI	1"1/4 BSP	1"1/4	B90RG62020	55,93
6000 PSI	1"1/2 BSP	1"1/2	B90RG62424	67,75

Bridas SAE

SAE Flanges
Brides de fixation SAE
Flange SAE

Table Pipe

Pipe Fittings DIN 2353
/ Flare fittings JIC 37°

SAE Flanges

Table Clamps

Machines for
processing rigid pipes

Brida soldable hembra tubo gas

Welding female flange for gas tube

Bride à souder femelle tube gaz

Flangia femmina a saldare per tubo gas

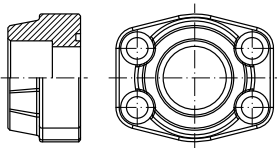

SERIE	Ø INNER Ø INT.	SIZE TAMAÑO	Part nº Referencia	€
3000 PSI	21.6	1/2"	BBSG308216	10,83
3000 PSI	17.5	1/2"	BBSG308175	28,14
3000 PSI	27.2	3/4"	BBSG312272	13,21
3000 PSI	34	1"	BBSG316340	15,22
3000 PSI	42.8	1"1/4	BBSG320428	20,16
3000 PSI	48.6	1"1/2	BBSG324486	27,04
3000 PSI	61	2"	BBSG332610	30,51
3000 PSI	76.6	2"1/2	BBSG340766	48,90
3000 PSI	90.5	3"	BBSG348905	42,26
3000 PSI	103	3"1/2	BBSG3561030	60,10
3000 PSI	115.5	4"	BBSG341155	110,00
6000 PSI	17.5	1/2"	BBSG608175	15,76
6000 PSI	21.6	1/2"	BBSG608216	15,76
6000 PSI	27.2	3/4"	BBSG612272	21,09
6000 PSI	34	1"	BBSG621612	25,72
6000 PSI	42.8	1"1/4	BBSG620428	36,69
6000 PSI	48.6	1"1/2	BBSG624486	61,10
6000 PSI	61	2"	BBSG632610	88,37

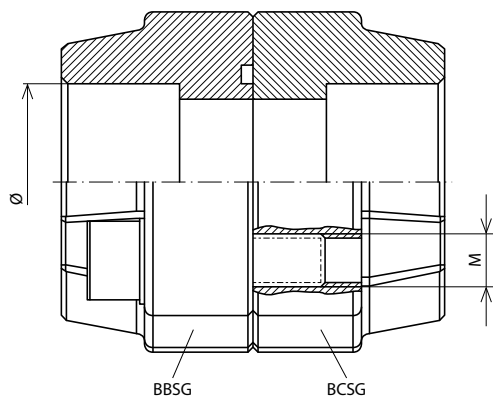

Contrabrida soldable hembra tubo gas

Welding female counter-flange for gas tube

Contre-bride à souder femelle tube gaz

Controflangia femmina a saldare per tubo gas

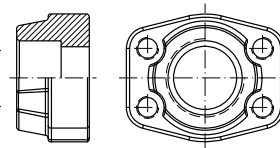

SERIE	Ø INNER Ø INT.	SIZE TAMAÑO	Part nº Referencia	€
3000 PSI	21.6	1/2"	BCSG308216	13,98
3000 PSI	17.5	1/2"	BCSG308175	11,59
3000 PSI	27.2	3/4"	BCSG312272	13,21
3000 PSI	34	1"	BCSG316340	15,22
3000 PSI	42.8	1"1/4	BCSG320428	20,16
3000 PSI	48.6	1"1/2	BCSG324486	27,04
3000 PSI	61	2"	BCSG332610	30,51
3000 PSI	76.6	2"1/2	BCSG340766	35,07
3000 PSI	90.5	3"	BCSG348905	55,74
3000 PSI	103	3"1/2	BCSG3561030	60,10
3000 PSI	115.5	4"	BCSG3641155	64,19
6000 PSI	21.6	1/2"	BCSG608216	15,76
6000 PSI	27.2	3/4"	BCSG612272	21,09
6000 PSI	34	1"	BCSG616340	25,72
6000 PSI	42.8	1"1/4	BCSG620428	36,69
6000 PSI	48.6	1"1/2	BCSG624486	61,10
6000 PSI	61	2"	BCSG632610	88,37

Brida codo 90° soldable hembra tubo gas

90° welding female flange for gas tube

Bride 90° à souder femelle tube gaz

Flangia a 90° femmina a saldare per tubo gas

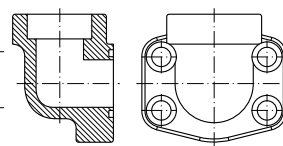

SERIE	Ø INNER Ø INT.	SIZE TAMAÑO	Part nº Referencia	€
3000 PSI	21.6	1/2"	B90SG308216	40,05
3000 PSI	17.5	1/2"	B90SG308175	40,05
3000 PSI	27.2	3/4"	B90SG312272	43,20
3000 PSI	34	1"	B90SG316340	47,91
3000 PSI	42.8	1"1/4	B90SG320428	42,26
3000 PSI	48.6	1"1/2	B90SG324486	51,76
3000 PSI	61	2"	B90SG332610	63,04
6000 PSI	21.6	1/2"	B90SG608216	43,20
6000 PSI	17.5	1/2"	B90SG608175	43,20
6000 PSI	27.2	3/4"	B90SG612272	36,31
6000 PSI	34	1"	B90SG616340	42,26
6000 PSI	42.8	1"1/4	B90SG620428	68,31
6000 PSI	48.6	1"1/2	B90SG624486	83,22

Bridas SAE

SAE Flanges
Brides de fixation SAE
Flange SAE

Brida soldable hembra tubo métrico

Female welding flange for metric tube

Bride à souder femelle tube métrique

Flangia femmina a saldare per tubo Metrico

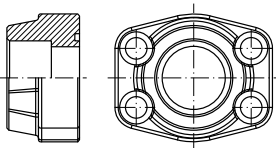

SERIE	Ø INNER Ø INT.	SIZE TAMAÑO	Part nº Referencia	€
3000 PSI	20.3	1/2"	BBSM308203	18,42
3000 PSI	25.3	3/4"	BBSM312253	14,52
3000 PSI	30.3	1"	BBSM316303	17,00
3000 PSI	38.3	1"1/4	BBSM320383	19,39
3000 PSI	50.5	1"1/2	BBSM324505	24,87
6000 PSI	20.3	1/2"	BBSM608203	20,81
6000 PSI	25.3	3/4"	BBSM612253	22,42
6000 PSI	30.3	1"	BBSM616303	20,01
6000 PSI	38.3	1"1/4	BBSM620383	27,96
6000 PSI	50.5	1"1/2	BBSM624505	41,64

Brida codo 90° soldable hembra tubo métrico

90° female welding flange for metric tube

Bride 90° à souder femelle tube métrique

Flangia a 90° femmina a saldare per tubo Metrico

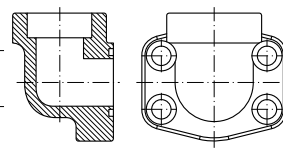

SERIE	Ø INNER Ø INT.	SIZE TAMAÑO	Part nº Referencia	€
3000 PSI	20.3	1/2"	B90SM308203	38,40
3000 PSI	25.3	3/4"	B90SM312253	44,17
3000 PSI	30.3	1"	B90SM316303	47,25
3000 PSI	38.3	1"1/4	B90SM320383	60,44
3000 PSI	50.5	1"1/2	B90SM324505	91,89
6000 PSI	20.3	1/2"	B90SM608203	44,75
6000 PSI	25.3	3/4"	B90SM612253	45,23
6000 PSI	30.3	1"	B90SM616303	42,26
6000 PSI	38.3	1"1/4	B90SM620383	51,76
6000 PSI	50.3	1"1/2	B90SM624503	63,04

Contrabrida soldable hembra tubo métrico

Female welding counter-flange for metric tube

Contre-bride à souder femelle tube métrique

Controflangia femmina a saldare per tubo
Metrico

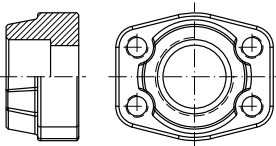

SERIE	Ø INNER Ø INT.	SIZE TAMAÑO	Part nº Referencia	€
3000 PSI	20.3	1/2"	BCSM308203	18,42
3000 PSI	25.3	3/4"	BCSM312253	14,52
3000 PSI	30.3	1"	BCSM316303	17,00
3000 PSI	38.3	1"1/4	BCSM320383	19,39
6000 PSI	20.3	1/2"	BCSM608203	15,76
6000 PSI	25.3	3/4"	BCSM612253	17,00
6000 PSI	30.3	1"	BCSM616303	20,01
6000 PSI	38.3	1"1/4	BCSM620383	27,96
6000 PSI	50.5	1"1/2	BCSM624505	41,64

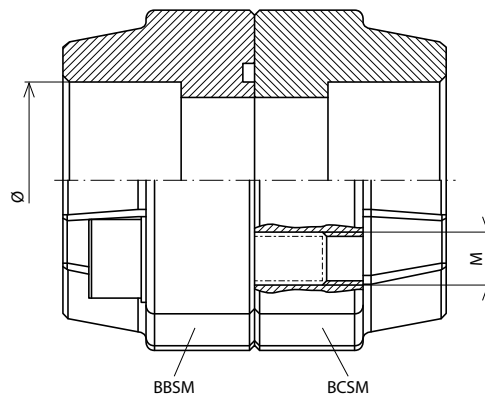

Bridas SAE

SAE Flanges
Brides de fixation SAE
Flange SAE

Tubing Pipe

Pipe Fittings, DIN 2353
/ Flare fittings, JIC 37°

SAE Flanges

Tubing Clamps

Machines for
processing rigid pipes

Brida soldable macho tubo gas

Male welding flange for gas tube

Bride à souder mâle tube gaz

Flangia a saldare maschio tubo gas

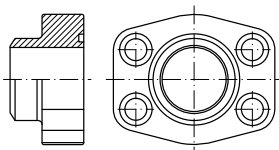

SERIE	Ø OUTER Ø EXT.	SIZE TAMAÑO	Part nº Referencia	€
3000 PSI	21.5	1/2"	BMSG308215	13,98
3000 PSI	17.5	1/2"	BMSG308175	13,98
3000 PSI	28	3/4"	BMSG312280	19,21
3000 PSI	34	1"	BMSG316340	17,00
3000 PSI	42.8	1 1/4"	BMSG320428	25,61
3000 PSI	48.6	1 1/2"	BMSG324486	32,83
3000 PSI	61	2"	BMSG332610	29,74
3000 PSI	77	2 1/2"	BMSG340770	35,07
3000 PSI	92	3"	BMSG348920	42,26
3000 PSI	103	3 1/2"	BMSG356103	60,10
6000 PSI	21.5	1/2"	BMSG608215	15,76
6000 PSI	17.5	1/2"	BMSG608175	15,76
6000 PSI	28	3/4"	BMSG612280	22,42
6000 PSI	34	1"	BMSG616340	26,43
6000 PSI	42.8	1 1/4"	BMSG620428	36,92
6000 PSI	48.6	1 1/2"	BMSG624486	54,95
6000 PSI	61	2"	BMSG632610	54,85

Contrabrida soldable macho tubo gas

Male welding counter-flange for gas tube

Contre-bride à souder mâle tube gaz

Controflangia a saldare maschio tubo gas

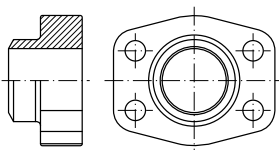

SERIE	Ø OUTER Ø EXT.	SIZE TAMAÑO	Part nº Referencia	€
3000 PSI	21.5	1/2"	BCMSG308215	13,98
3000 PSI	17.5	1/2"	BCMSG308175	13,98
3000 PSI	28	3/4"	BCMSG312280	19,21
3000 PSI	34	1"	BCMSG316340	22,42
3000 PSI	42.8	1 1/4"	BCMSG320428	25,61
3000 PSI	48.6	1 1/2"	BCMSG324486	24,87
3000 PSI	61	2"	BCMSG332610	29,74
3000 PSI	77	2 1/2"	BCMSG340770	46,32
3000 PSI	92	3"	BCMSG348920	42,26
3000 PSI	103	3 1/2"	BCMSG561030	60,10
3000 PSI	115.5	4"	BCMSG3641155	64,19
6000 PSI	21.5	1/2"	BCMSG608215	15,76
6000 PSI	17.5	1/2"	BCMSG608175	15,76
6000 PSI	28	3/4"	BCMSG612280	17,00
6000 PSI	34	1"	BCMSG616340	26,42
6000 PSI	42.8	1 1/4"	BCMSG620428	27,96
6000 PSI	48.6	1 1/2"	BCMSG624486	41,64
6000 PSI	61	2"	BCMSG632610	54,85

Brida soldable macho tubo métrico

Male welding flange for metric tube

Bride à souder mâle tube métrique

Flangia a saldare maschio tubo Metrico

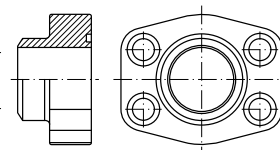

SERIE	Ø OUTER Ø EXT.	SIZE TAMAÑO	Part nº Referencia	€
3000 PSI	25	3/4"	BMSM31225	19,21
3000 PSI	30	1"	BMSM31630	22,42
3000 PSI	38	1 1/4"	BMSM32038	25,61
3000 PSI	42	1 1/2"	BMSM32442	32,83
3000 PSI	61	2"	BMSM33261	29,74
3000 PSI	49	2"	BMSM33249	29,74
3000 PSI	77	3"	BMSM34877	42,26
3000 PSI	77	3 1/2"	BMSM35677	79,30
3000 PSI	90	3 1/2"	BMSM35690	79,30
3000 PSI	77	4"	BMSM36477	64,19
3000 PSI	90	4"	BMSM36490	64,19
6000 PSI	20	1/2"	BMSM60820	15,76
6000 PSI	20	3/4"	BMSM61220	22,42
6000 PSI	25	3/4"	BMSM61225	22,42
6000 PSI	25	1"	BMSM61625	26,43
6000 PSI	30	1"	BMSM61630	26,43
6000 PSI	38	1 1/4"	BMSM62038	36,92
6000 PSI	38	1 1/2"	BMSM62438	54,95
6000 PSI	61	2"	BMSM63261	54,85

Contrabrida soldable macho tubo métrico

Male welding counter-flange for metric tube

Contre-bride à souder mâle tube métrique

Controflangia a saldare maschio tubo Metrico

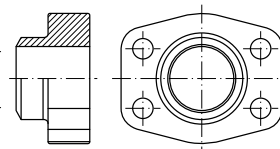

SERIE	Ø OUTER Ø EXT.	SIZE TAMAÑO	Part nº Referencia	€
3000 PSI	25	3/4"	BCMSM31225	14,52
3000 PSI	30	1"	BCMSM31630	17,00
3000 PSI	38	1 1/4"	BCMSM32038	25,61
3000 PSI	42	1 1/2"	BCMSM32442	24,87
3000 PSI	49	1 1/2"	BCMSM32449	32,83
3000 PSI	61	2"	BCMSM33261	29,74
3000 PSI	49	2"	BCMSM33249	39,26
3000 PSI	77	2 1/2"	BCMSM34077	35,07
3000 PSI	77	3"	BCMSM34877	42,26
3000 PSI	77	3 1/2"	BCMSM35677	60,10
3000 PSI	90	3 1/2"	BCMSM35690	60,10
3000 PSI	90	4"	BCMSM36490	64,19
6000 PSI	20	1/2"	BCMSM60820	15,76
6000 PSI	20	3/4"	BCMSM61220	22,42
6000 PSI	25	3/4"	BCMSM61225	22,42
6000 PSI	25	1"	BCMSM61625	26,43
6000 PSI	30	1"	BCMSM61630	26,43
6000 PSI	38	1 1/4"	BCMSM62038	36,92
6000 PSI	38	1 1/2"	BCMSM62438	54,95
6000 PSI	61	2"	BCMSM63261	54,85

Bridas SAE

SAE Flanges
Brides de fixation SAE
Flange SAE

Brida soldable macho serie L tubo métrico

Male welding flange L serie for metric tube

Bride à souder mâle série L tube métrique

Flangia a saldare maschio serie L tubo Metrico

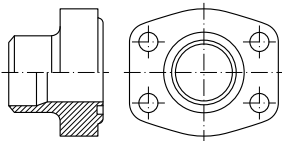

SERIE	Ø OUTER Ø EXT.	SIZE TAMAÑO	Part nº Referencia	€
3000 PSI	20	1/2"	BMSLM30820	18,42
3000 PSI	22	1/2"	BMSLM30822	18,42
3000 PSI	28	3/4"	BMSLM31228	19,21
3000 PSI	35	1"	BMSLM31635	22,42
3000 PSI	43	1"1/4	BMSLM32043	25,61
3000 PSI	49	1"1/2	BMSLM32449	32,83
3000 PSI	61	2"	BMSLM33261	39,26
3000 PSI	77	2"1/2	BMSLM34077	35,07
3000 PSI	90	3"	BMSLM34890	55,74
3000 PSI	115	4"	BMSLM364115	64,19

Contrabrida soldable macho serie L tubo métrico

Male welding counter-flange L serie for metric tube

Contre-bride à souder mâle série L tube métrique

Controflangia a saldare maschio serie L tubo Metrico

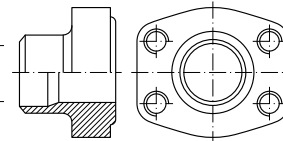

SERIE	Ø OUTER Ø EXT.	SIZE TAMAÑO	Part nº Referencia	€
3000 PSI	20	1/2"	BCMSLM30820	18,42
3000 PSI	22	1/2"	BCMSLM30822	18,42
3000 PSI	28	3/4"	BCMSLM31228	19,21
3000 PSI	35	1"	BCMSLM31635	22,42
3000 PSI	43	1"1/4	BCMSLM32043	25,61
3000 PSI	49	1"1/2	BCMSLM32449	32,83
3000 PSI	61	2"	BCMSLM33261	29,74
3000 PSI	77	2"1/2	BCMSLM34077	35,07
3000 PSI	90	3"	BCMSLM34890	42,26
3000 PSI	115	4"	BCMSLM364115	64,19

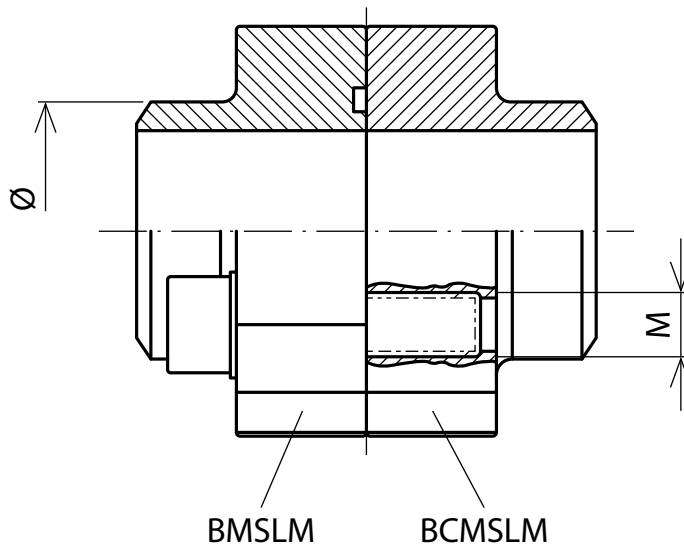

Bridas SAE

SAE Flanges
Brides de fixation SAE
Flange SAE

Tornillos para bridas SAE

Screws for SAE flanges

Vis pour bridas SAE

Vite per flangia SAE



THREAD ROSCA	SIZE TAMAÑO	Part nº Referencia	€
M8X30	3000-6000 PSI 1/2"	TB8X30	0,17
M10X35	3000 PSI 3/4"-1"	TB10X35	0,38
M10X40	3000 PSI 1" 1/4 - 6000 PSI 3/4"	TB10X40	0,41
M12X45	3000 PSI 1"1/2-2"-2"1/2-6000 PSI 1"	TB12X45	0,60
M14X45	6000 PSI 1"1/4	TB14X45	0,89
M16X50	3000 PSI 3"-3" 1/2-4"- 6000 PSI 1" 1/2	TB16X50	1,31
M20X70	6000 PSI 2"	TB20X70	2,29

Juntas para bridas SAE 3000/6000 PSI

Seals for 3000/6000 PSI flange

Joints pour bride série 3000/6000

Guarnizioni per flangia SAE 3000/6000 PSI



Ø OUTER Ø EXT.	Ø INNER Ø INT.	SIZE TAMAÑO	Part nº Referencia	€
25.40	17.02	1/2"	JBR08	*
31.72	23.36	3/4"	JBR12	*
39.62	31.24	1"	JBR16	*
44.45	36.07	1"1/4	JBR20	*
53.98	45.34	1"1/2	JBR24	*
63.50	54.86	2"	JBR32	*

*Ver precios en p.58 / *See prices page 58 / *Voir les prix page 58 / *Vedere prezzi p.58

Juntas tóricas para bridas SAE 3000/6000 PSI

O´rings for 3000/6000 PSI flange

O´rings pour bride série 3000/6000 PSI

O´rings per flangia SAE 3000/6000 PSI



Ø INNER Ø INT.	SIZE TAMAÑO	Part nº Referencia	€
18.64	1/2"	18.64X3.53	*
24.99	3/4"	24.99X3.53	*
32.92	1"	32.92X3.53	*
37.70	1"1/4	37.70X3.53	*
47.22	1"1/2	47.22X3.53	*
56.74	2"	56.74X3.53	*

*Ver precios en p.58 / *See prices page 58 / *Voir les prix page 58 / *Vedere prezzi p.58

Bridas SAE

SAE Flanges
Brides de fixation SAE
Flange SAE

Brida roscada macho BSP

BSP Male threaded flange

Brides taraudées mâle BSP

Flangia maschio filettata BSP

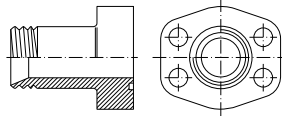

SERIE	THREAD ROSCA	SIZE TAMAÑO	Part nº Referencia	€
3000 PSI	3/8" BSP	1/2"	BMRG30806	31,22
3000 PSI	1/2" BSP	1/2"	BMRG30808	27,21
3000 PSI	3/4" BSP	3/4"	BMRG31212	26,11
3000 PSI	1/2" BSP	3/4"	BMRG31208	26,11
3000 PSI	1" BSP	1"	BMRG31616	17,75
3000 PSI	3/4" BSP	1"	BMRG31612	17,75
3000 PSI	1"1/4 BSP	1"1/4	BMRG32020	22,14
3000 PSI	1" BSP	1"1/4	BMRG32016	22,14
3000 PSI	1"1/2 BSP	1"1/2	BMRG32424	29,85
3000 PSI	1"1/4 BSP	1"1/2	BMRG32420	29,85
6000 PSI	1/2" BSP	1/2"	BMRG60808	29,61
6000 PSI	3/8" BSP	1/2"	BMRG60806	32,01
6000 PSI	3/4" BSP	3/4"	BMRG61212	24,47
6000 PSI	1/2" BSP	3/4"	BMRG61208	39,23
6000 PSI	1" BSP	1"	BMRG61616	29,85
6000 PSI	3/4" BSP	1"	BMRG61612	29,85
6000 PSI	1"1/4 BSP	1"1/4	BMRG62020	36,69
6000 PSI	1" BSP	1"1/4	BMRG62016	42,58
6000 PSI	1"1/2 BSP	1"1/2	BMRG62424	46,43
6000 PSI	1"1/4 BSP	1"1/2	BMRG62420	51,14

Brida roscada macho métrico

Metric Male threaded flange

Brides taraudées mâle Métrique

Flangia maschio filettata Metrica

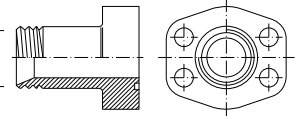

SERIE	THREAD ROSCA	SIZE TAMAÑO	Part nº Referencia	€
3000 PSI	M22x1,5	1/2"	BMRM30822	30,84
3000 PSI	M30x2	3/4"	BMRM31230	35,38
3000 PSI	M36x2	1"	BMRM31636	41,74
3000 PSI	M45x2	1"1/4	BMRM32045	49,89
3000 PSI	M52x2	1"1/2	BMRM32452	59,86
6000 PSI	M24x1.5	1/2"	BMRM60824	33,56
6000 PSI	M36X2	3/4"	BMRM61236	40,81
6000 PSI	M42x2	1"	BMRM61642	49,89
6000 PSI	M52x2	1"1/4	BMRM62052	58,74
6000 PSI	M52x2	1"1/2	BMRM62452	69,40

Bridas ciegas

Blind flanges

Brides avec obturateur fermé

Flangia cieche

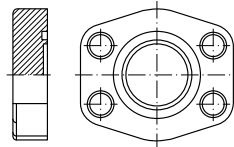

SERIE	SIZE TAMAÑO	Part nº Referencia	€
3000 PSI	1/2"	BBC308	12,28
3000 PSI	3/4"	BBC312	10,89
3000 PSI	1"	BBC316	11,67
3000 PSI	1"1/4	BBC320	13,36
3000 PSI	1"1/2	BBC324	13,60
3000 PSI	2"	BBC332	28,74
3000 PSI	2"1/2	BBC340	24,35
3000 PSI	3"	BBC348	29,12
3000 PSI	3"1/2	BBC356	34,45
3000 PSI	4"	BBC364	36,77
3000 PSI	5"	BBC380	78,18
6000 PSI	1/2"	BBC608	12,13
6000 PSI	3/4"	BBC612	12,75
6000 PSI	1"	BBC616	14,52
6000 PSI	1"1/4	BBC620	17,23
6000 PSI	1"1/2	BBC624	20,24
6000 PSI	2"	BBC632	32,06

Contrabridas ciegas

Blind counter-flanges

Contre-brides avec obturateur fermé

Controflangia cieche

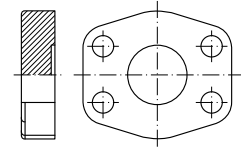

SERIE	SIZE TAMAÑO	Part nº Referencia	€
3000 PSI	1/2"	BCC308	10,35
3000 PSI	3/4"	BCC312	10,89
3000 PSI	1"	BCC316	12,75
3000 PSI	1"1/4	BCC320	17,63
3000 PSI	1"1/2	BCC324	20,81
3000 PSI	2"	BCC332	16,07
3000 PSI	2"1/2	BCC340	24,35
3000 PSI	3"	BCC348	29,12
3000 PSI	3"1/2	BCC356	34,45
3000 PSI	4"	BCC364	48,52
3000 PSI	5"	BCC380	78,18
6000 PSI	1/2"	BCC608	12,13
6000 PSI	3/4"	BCC612	12,75
6000 PSI	1"	BCC616	14,52
6000 PSI	1"1/4	BCC620	17,23
6000 PSI	1"1/2	BCC624	20,24
6000 PSI	2"	BCC632	32,06

Bridas SAE

SAE Flanges
Brides de fixation SAE
Flange SAE

Brida partida pasante

SAE Split flange

Demi-bride SAE passage total

Semiflangua SAE

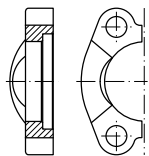

SERIE	SIZE TAMAÑO	Part nº Referencia	€
3000 PSI	1/2"	BBP308	*
3000 PSI	3/4"	BBP312	*
3000 PSI	1"	BBP316	*
3000 PSI	1"1/4	BBP320	*
3000 PSI	1"1/2	BBP324	*
3000 PSI	2"	BBP332	*
3000 PSI	2"1/2	BBP340	*
3000 PSI	3"	BBP348	*
3000 PSI	3"1/2	BBP356	*
3000 PSI	4"	BBP364	*
6000 PSI	1/2"	BBP608	*
6000 PSI	3/4"	BBP612	*
6000 PSI	1"	BBP616	*
6000 PSI	1"1/4	BBP620	*
6000 PSI	1"1/2	BBP624	*
6000 PSI	2"	BBP632	*

*Ver precios en p.58 (Conexiones Standard) / *See prices in p.58 (Standard Serie Fittings) / *Prix à la p.58 (Emboutis Série Standard) / *Vedere prezzi p.58 (Raccordi Serie Standard)

Brida entera pasante

SAE Flange

Bride SAE monobloc passage total

Flangia monoblocco SAE

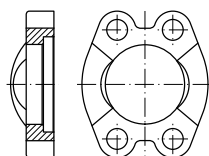

SERIE	SIZE TAMAÑO	Part nº Referencia	€
3000 PSI	1/2"	BBE308	*
3000 PSI	3/4"	BBE312	*
3000 PSI	1"	BBE316	*
3000 PSI	1"1/4	BBE320	*
3000 PSI	1"1/2	BBE324	*
3000 PSI	2"	BBE332	*
3000 PSI	2"1/2	BBE340	*
3000 PSI	3"	BBE348	*
3000 PSI	3"1/2	BBE356	*
3000 PSI	4"	BBE364	*
3000 PSI	5"	BBE380	*
6000 PSI	1/2"	BBE608	*
6000 PSI	3/4"	BBE612	*
6000 PSI	1"	BBE616	*
6000 PSI	1"1/4	BBE620	*
6000 PSI	1"1/2	BBE624	*
6000 PSI	2"	BBE632	*

*Ver precios en p.58 (Conexiones Standard) / *See prices in p.58 (Standard Serie Fittings) / *Prix à la p.58 (Emboutis Série Standard) / *Vedere prezzi p.58 (Raccordi Serie Standard)

Contrabrida rosca Métrica

Metric threaded counter-flange

Contre-bride métrique

Controflangia filettata Metrica

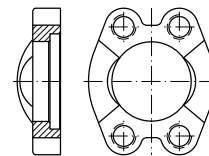

SERIE	SIZE TAMAÑO	Part nº Referencia	€
3000 PSI	1/2"	BCE308	12,36
3000 PSI	3/4"	BCE312	13,25
3000 PSI	1"	BCE316	15,24
3000 PSI	1"1/4	BCE320	17,96
3000 PSI	1"1/2	BCE324	20,87
3000 PSI	2"	BCE332	38,10
3000 PSI	2"1/2	BCE340	50,02
3000 PSI	3"	BCE348	72,25
3000 PSI	3"1/2	BCE356	107,17
3000 PSI	4"	BCE364	134,40
3000 PSI	5"	BCE380	163,36
6000 PSI	1/2"	BCE608	14,18
6000 PSI	3/4"	BCE612	15,24
6000 PSI	1"	BCE616	19,98
6000 PSI	1"1/4	BCE620	28,86
6000 PSI	1"1/2	BCE624	58,37
6000 PSI	2"	BCE632	81,69

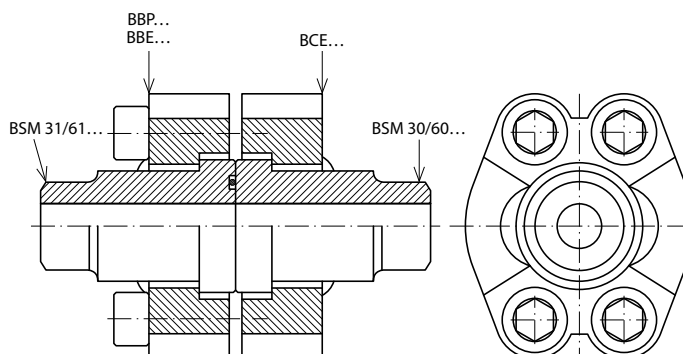

Bridas SAE

SAE Flanges
Brides de fixation SAE
Flange SAE

Brida cono soldable tubo métrico

Flange welding adaptor for metric tube

Bride collet à souder tube métrique

Flangia adattatore a saldare per tubo Metrico

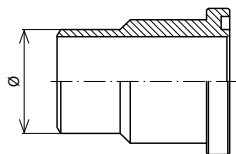

SERIE	Ø OUTER Ø EXT.	SIZE TAMAÑO	Part nº Referencia	€
3000 PSI	16	1/2"	BSM310816	13,36
3000 PSI	25	3/4"	BSM311225	6,45
3000 PSI	30	1"	BSM311630	9,05
3000 PSI	38	1"1/4	BSM3132038	10,31
3000 PSI	45	1"1/2	BSM312445	12,91
3000 PSI	60	2"	BSM313260	15,51
3000 PSI	70	2"1/2	BSM314070	33,91
3000 PSI	80	3"	BSM314880	60,45
3000 PSI	100	3"1/2	BSM3156100	77,94
3000 PSI	114.3	4"	BSM31641143	87,45
3000 PSI	139.7	5"	BSM31801397	124,87
6000 PSI	16	1/2"	BSM610816	6,45
6000 PSI	25	3/4"	BSM611225	9,05
6000 PSI	30	1"	BSM611630	12,91
6000 PSI	38	1"1/4	BSM612038	15,51
6000 PSI	45	1"1/2	BSM612445	19,27
6000 PSI	60	2"	BSM613260	25,73

Contrabrida cono soldable tubo métrico

Counter-flange welding adaptor for metric tube

Contrebride collet à souder tube métrique

Controflangia adattatore a saldare per tubo Metrico

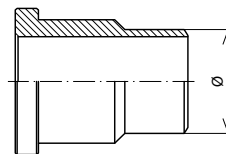

SERIE	Ø OUTER Ø EXT.	SIZE TAMAÑO	Part nº Referencia	€
3000 PSI	16	1/2"	BSM300816	10,12
3000 PSI	25	3/4"	BSM301225	11,28
3000 PSI	30	1"	BSM301630	11,90
3000 PSI	38	1"1/4	BSM302038	15,45
3000 PSI	45	1"1/2	BSM302445	19,62
3000 PSI	60	2"	BSM303260	25,57
3000 PSI	70	2"1/2	BSM304070	33,91
3000 PSI	80	3"	BSM304880	45,81
3000 PSI	100	3"1/2	BSM3056100	77,94
3000 PSI	114.3	4"	BSM30641143	87,45
3000 PSI	139.7	5"	BSM30801397	107,61
6000 PSI	16	1/2"	BSM600816	10,74
6000 PSI	25	3/4"	BSM601225	13,67
6000 PSI	30	1"	BSM601630	15,45
6000 PSI	38	1"1/4	BSM602038	17,85
6000 PSI	45	1"1/2	BSM602445	22,63
6000 PSI	60	2"	BSM603260	37,47

Cono Cetop soldable exterior

Cetop welding adaptor

Collet Cetop à souder

Adattatore a saldare Cetop

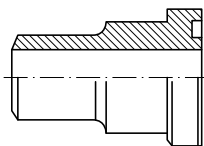

SERIE	Ø OUTER Ø EXT.	SIZE TAMAÑO	Part nº Referencia	€
3000 PSI	18	3/8"	BCTS30618	8,81
6000 PSI	18	3/8"	BCTS60618	10,58

Bridas Cetop

Cetop flanges

Brides Cetop

Flangia Cetop

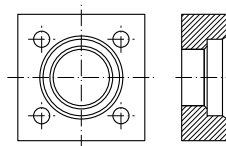

SERIE	Ø INNER Ø INT.	SIZE TAMAÑO	Part nº Referencia	€
3000 PSI	31	1/2"	BCT30831	8,81

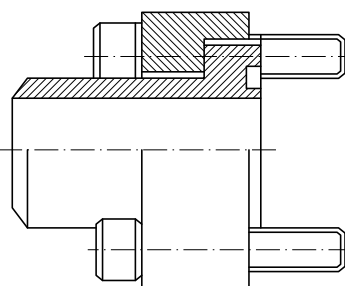
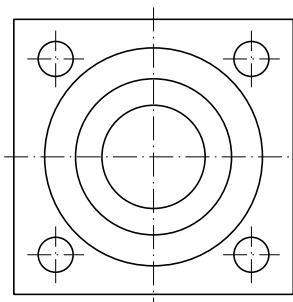

Bridas SAE

SAE flanges
Brides SAE
Flangia SAE

Características comunes

Common characteristics
Données communes
Caratteristiche comuni

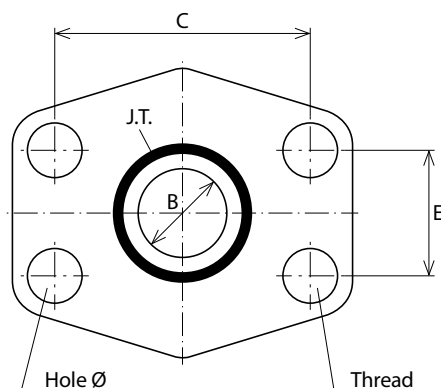

Bridas 3000 PSI

Flanges 3000 PSI
Brides 3000 PSI
Flangia 3000 PSI

Tamaño Size Taille Misura	Max. pre. Max. pre. Max. pre.	B	C	E	O'ring NBR O'ring NBR O'ring NBR	Junta PU PU seal Joint PU Guarnizione in PU	Ø	Tornillo * Screw * Vis * Vite *	Rosca Thread Filetage Filetto
1/2"	345 bar	13	38,1	17,48	18,64 x 3,53	JBR08	9	TB8X30	M8
3/4"	345 bar	19	47,63	22,23	24,99 x 3,53	JBR12	11	TB10X35	M10
1"	345 bar	25	52,37	26,19	32,92 x 3,53	JBR16	11	TB10X35	M10
1 1/4"	276 bar	32	58,72	30,18	37,70 x 3,53	JBR20	11,5	TB10X40	M10
1 1/2"	207 bar	38	69,85	35,71	47,22 x 3,53	JBR24	13,5	TB12X45	M12
2"	207 bar	51	77,77	42,88	56,74 x 3,53	JBR32	13,5	TB12X45	M12
2 1/2"	172 bar	63	88,9	50,8	66,27 x 3,53		13,5	TB12X45	M12
3"	138 bar	73	106,38	61,93	85,32 x 3,53		17,5	TB16X50	M16
3 1/2"	34 bar	89	120,65	69,85	98,02 x 3,53		17,5	TB16X50	M16
4"	34 bar	99	130,18	77,77	110,72 x 3,53		17,5	TB16X50	M16

Bridas 6000 PSI

Flanges 6000 PSI
Brides 6000 PSI
Flangia 6000 PSI

Tamaño Size Taille Misura	Max. pre. Max. pre. Max. pre.	B	C	E	O'ring NBR O'ring NBR O'ring NBR	Junta PU PU seal Joint PU Guarnizione PU	Ø	Tornillo * Screw * Vis * Vite *	Rosca Thread Filetage Filetto
1/2"	414 bar	13	40,49	18,24	18,64 x 3,53	JBR08	9	TB8X30	M8
3/4"	414 bar	19	50,8	23,8	24,99 x 3,53	JBR12	11	TB10X40	M10
1"	414 bar	25	57,15	27,76	32,92 x 3,53	JBR16	13	TB12X45	M12
1 1/4"	414 bar	32	66,68	31,75	37,70 x 3,53	JBR20	15	TB14X45	M14
1 1/2"	414 bar	38	79,38	36,5	47,22 x 3,53	JBR24	17	TB16X50	M16
2"	414 bar	51	98,82	44,45	56,74 x 3,53	JBR32	21	TB20X70	M20

* Tornillos en acero carbono. Para tornillos en acero inoxidable, pedir ZTB...

Screws are in carbon steel. For Stainless Steel screws, ask for ZTB... part number.
Les vis sont en acier. Pour vis en acier inoxydable, veuillez demander les références ZTB ...
Le viti sono in acciaio al carbonio. Per viti in acciaio inox, ordinare con codice ZTB...

Abrazaderas TrΔle

TrΔle Clamps

Colliers TrΔle

Collari fissatubo TrΔle

Abrazaderas Serie ligera TrΔle

Clamps for pipe - TrΔle
Colliers de fixation TrΔle
Collari Serie leggera TrΔle

262

Abrazaderas Serie doble TrΔle

Clamps double Series - TrΔle
Colliers Serie double TrΔle
Collari Serie doppi TrΔle

266

Abrazaderas Serie pesada TrΔle

Clamps heavy Series - TrΔle
Colliers Série lourde TrΔle
Collari Serie pesante TrΔle

268

Accesorios abrazaderas TrΔle

Accessories for clamps - TrΔle
Accessoires colliers TrΔle
Accessori per collari TrΔle

271

4

Abrazaderas Serie ligera TrΔle

Clamps for pipe - TrΔle
 Colliers de fixation TrΔle
 Collari Serie leggera TrΔle

■ Completas / Light serie clamp / Colliers de fixation série légère / Collari fissatubo serie leggera

| 262



■ Componentes / Parts / Composants / Accessori

| 264



■ Accesorios / Accessories / Accessoires / Accessori

| 265



Abrazaderas Serie doble TrΔle

Clamps double Series - TrΔle

Colliers Serie double TrΔle

Collari Serie doppi TrΔle

■ Completas / Double / Complets / Doppio

| 266



AZCFS

■ Componentes / Parts / Composants / Accessori

| 266



ADPIN



ADVTE



ADPS



ADC

■ Accesorios / Accessories / Accessori / Accessori

| 267



ADPA



ADPAG



ADVTA

Abrazaderas Serie pesada TrΔle

Clamps heavy Series - TrΔle

Colliers Série lourde TrΔle

Collari Serie pesante TrΔle

■ Completas / Complete / Complètes / Completo

| 268



AZCPS

■ Componentes / Parts / Accessoires / Accessori

| 269



APINP



APSP



AVTEP



AMPP C



AMS



APAP



APVTA

Accesorios abrazaderas TrΔle

Accessories for clamps - TrΔle

Accessoires colliers TrΔle

Accessori per collari TrΔle

- Accesorios carril / Accessories for lane / Accessoires pour lane / Accessori per binario

| 271



TC/T5

TrΔle Pipe

Pipe Fittings DIN 2353
/ Flare fittings JIC 37°

SAE Flanges

TrΔle Clamps

Machines for
processing rigid pipes

Abrazaderas Serie ligera TrΔle

Clamps for pipe - TrΔle
Colliers de fixation TrΔle
Collari Serie leggera TrΔle

Abrazadera simple completa, serie ligera

Light series simple clamp

Collier de fixation complet simple, série légère

Collari fissatubo serie leggera singoli



DN	GROUP GRUPO	UNITS PER BAG CANTIDAD / BOLSA	Part nº Referencia	€
6	1	10	A40AZ06	1,50
8	1	10	A40AZ08	1,50
10	1	10	A40AZ10	1,50
12	1	10	A40AZ12	1,50
1/4"	2	10	A40AZ13.2	1,60
14	2	10	A40AZ14	1,60
15	2	10	A40AZ15	1,60
16	2	10	A40AZ16	1,60
3/8"	2	10	A40AZ16.7	1,60
18	2	10	A40AZ18	1,60
19	3	10	A40AZ19	1,90
20	3	10	A40AZ20	1,90
1/2"	3	10	A40AZ21.3	1,90
22	3	10	A40AZ22	1,90
25	3	10	A40AZ25	1,90
3/4"	4	10	A40AZ26.7	2,19
28	4	10	A40AZ28	2,19
30	4	10	A40AZ30	2,19
32	5	10	A40AZ32	2,83
1"	5	10	A40AZ33.3	2,83
35	5	10	A40AZ35	2,83
38	5	10	A40AZ38	2,83
40	5	10	A40AZ40	2,83
42	5	10	A40AZ42	2,83
1"1/2	6	10	A40AZ48.3	3,86
50.8	6	10	A40AZ50.8	3,86

Consultar plásticos en poliamida / Polyamide plastics on request / Plastique polyamide sur demande / Plastica polyamide su richiesta

Abrazadera completa, serie ligera reforzada

Light series reinforced clamp

Colliers de fixation simple série légère renforcés

Collare fissatubo rin forzato completo



DN	GROUP GRUPO	UNITS PER BAG CANTIDAD / BOLSA	Part nº Referencia	€
6	1	10	A41AZ06	1,81
8	1	10	A41AZ08	1,81
10	1	10	A41AZ10	1,81
12	1	10	A41AZ12	1,81
1/4"	2	10	A41AZ13.2	2,02
14	2	10	A41AZ14	2,02
15	2	10	A41AZ15	2,02
16	2	10	A41AZ16	2,02
3/8"	2	10	A41AZ16.7	2,02
18	2	10	A41AZ18	2,02
20	3	10	A41AZ20	2,36
1/2"	3	10	A41AZ21.3	2,36
22	3	10	A41AZ22	2,36
25	3	10	A41AZ25	2,36
3/4"	4	10	A41AZ26.7	2,72
28	4	10	A41AZ28	2,72
30	4	10	A41AZ30	2,72
1"	5	10	A41AZ33.7	3,46
35	5	10	A41AZ35	3,46
38	5	10	A41AZ38	3,46
40	5	10	A41AZ40	3,46
42	5	10	A41AZ42	3,46
44.5	6	10	A41AZ44.5	4,62
1"1/2	6	10	A41AZ48.3	4,62
50.8	6	10	A41AZ50.8	4,62

Consultar plásticos en poliamida / Polyamide plastics on request / Plastique polyamide sur demande / Plastica polyamide su richiesta

Abrazadera simple completa, serie ligera, plásticos perfil liso

Light series simple clamp, plastic smooth profile

Collier de fixation complet simple, série légère, plastique profil lisse

Collari fissatubo serie leggera singoli, plastica profil liso



DN	GROUP GRUPO	UNITS PER BAG CANTIDAD / BOLSA	Part nº Referencia	€
8	1	10	A40AZ08PL	1,50
10	1	10	A40AZ10PL	1,50
12	1	10	A40AZ12PL	1,50
1/4"	2	10	A40AZ13.2PL	1,60
15	2	10	A40AZ15PL	1,60
3/8"	2	10	A40AZ16.7PL	1,60
18	2	10	A40AZ18PL	1,60
20	3	10	A40AZ20PL	1,90
1/2"	3	10	A40AZ21.3PL	1,90
22	3	10	A40AZ22PL	1,90
25	3	10	A40AZ25PL	1,90
3/4"	4	10	A40AZ26.7PL	2,19
28	4	10	A40AZ28PL	2,19
30	4	10	A40AZ30PL	2,19
1"	5	10	A40AZ33.3PL	2,83
35	5	10	A40AZ35PL	2,83
38	5	10	A40AZ38PL	2,83
42	5	10	A40AZ42PL	2,83

Abrazadera completa, serie ligera reforzada, plásticos perfil liso

Light series reinforced clamp, plastic smooth profile

Colliers de fixation simple série légère renforcés, plastique profil lisse

Collare fissatubo rin forzato completo, plastica profil liso



DN	GROUP GRUPO	UNITS PER BAG CANTIDAD / BOLSA	Part nº Referencia	€
8	1	10	A41AZ08PL	1,81
10	1	10	A41AZ10PL	1,81
12	1	10	A41AZ12PL	1,81
1/4"	2	10	A41AZ13.2PL	2,02
15	2	10	A41AZ15PL	2,02
3/8"	2	10	A41AZ16.7PL	2,02
18	2	10	A41AZ18PL	2,02
20	3	10	A41AZ20PL	2,36
1/2"	3	10	A41AZ21.3PL	2,36
22	3	10	A41AZ22PL	2,36
25	3	10	A41AZ25PL	2,36
3/4"	4	10	A41AZ26.7PL	2,72
28	4	10	A41AZ28PL	2,72
30	4	10	A41AZ30PL	2,72
1"	5	10	A41AZ33.3PL	3,46
35	5	10	A41AZ35PL	3,46
38	5	10	A41AZ38PL	3,46
42	5	10	A41AZ42PL	3,46

Abrazaderas Serie ligera TrΔle

Clamps for pipe - TrΔle
Colliers de fixation TrΔle
Collari Serie leggera TrΔle

TrΔle pipe

Pipe Fittings, DIN 2353 / Flare fittings, JIC 37°

SAE Flanges

TrΔle clamps

Machines for processing rigid pipes

Abrazadera simple completa, serie ligera, Aluminio

Complete simple clamp, light series, aluminium

Collier simple complet, série légère, aluminium

Collare fissatubo completo singolo, serie leggera, in Alluminio



GROUP GRUPO	UNITS PER BAG CANTIDAD / BOLSA	Part nº Referencia	€
1	10	A40AL06	*
1	10	A40AL08	*
1	10	A40AL10	*
1	10	A40AL12	*
2	10	A40AL13.5	*
2	10	A40AL14	*
2	10	A40AL15	*
2	10	A40AL16	*
2	10	A40AL17.2	*
2	10	A40AL18	*
3	10	A40AL19	*
3	10	A40AL20	*
3	10	A40AL21.3	*
3	10	A40AL22	*
3	10	A40AL25	*
4	10	A40AL26.9	*
4	10	A40AL28	*
4	10	A40AL30	*
5	10	A40AL32	*
5	10	A40AL33.7	*
5	10	A40AL35	*
5	10	A40AL38	*
5	10	A40AL40	*
5	10	A40AL42	*
6	10	A40AL48.3	*
6	10	A40AL50.8	*

Abrazadera completa, serie ligera reforzada, Aluminio

Complete simple clamp, light series reinforced, aluminium

Collier complet, série légère renforcée, aluminium

Collare fissatubo completo, serie leggera rinforzata, in Alluminio



GROUP GRUPO	UNITS PER BAG CANTIDAD / BOLSA	Part nº Referencia	€
1	10	A41AL06	*
1	10	A41AL08	*
1	10	A41AL10	*
1	10	A41AL12	*
2	10	A41AL13.5	*
2	10	A41AL14	*
2	10	A41AL15	*
2	10	A41AL16	*
2	10	A41AL17.2	*
2	10	A41AL18	*
3	10	A41AL19	*
3	10	A41AL20	*
3	10	A41AL21.3	*
3	10	A41AL22	*
3	10	A41AL25	*
4	10	A41AL26.9	*
4	10	A41AL28	*
4	10	A41AL30	*
5	10	A41AL32	*
5	10	A41AL33.7	*
5	10	A41AL35	*
5	10	A41AL38	*
5	10	A41AL40	*
5	10	A41AL42	*
6	10	A41AL48.3	*
6	10	A41AL50.8	*

PROPIEDADES DE MATERIALES | MATERIAL PROPERTIES

	POLIPROPILENO Polypropilene (PP)	POLIAMIDA Polyamide (PA)	ALUMINIO Aluminium (AL)	ELASTOMEROS TERMOPLASTICOS Thermoplastic elastomer (TPE)
PROPIEDADES MECÁNICAS Mechanical properties				
ENSAYO IZOD (Mellado, 23°C) Izod Impact Strength (Notched, 23°C)	>40 KJ/m2 ISO 180	>5 KJ/m2 ISO 180		
ENSAYO IZOD (Mellado, -30°C) Izod Impact Strength (Notched, -30°C)	>6 KJ/m2 ISO 180	>2 KJ/m2 ISO 180		
MÓDULO DE ELASTICIDAD Modulus of elasticity	1200-1250 N/mm2 ISO 527-2	>2000 N/mm2 ISO 527-2	70.000 N/mm2	3,6 N/mm2 (MODULUS@100) ASTM D 412
RESISTENCIA A LA TRACCIÓN Tensile strength	>23 N/mm2 ISO 527-2	>60 N/mm2 ISO 527-2	>160 N/mm2 DIN EN 10002	>3,95 N/mm2 ASTM D 412
DUREZA HARDNESS	>80 ISO 2039-2 (Rockwell-R)	>70 ISO 868 (Shore D)	>80 Brinell hardness	>85 ASTM D 2240 (Shore A)
RANGO DE TEMPERATURAS temperature range	-30°C/90°C	-40°C/120°C	Max. 300°C	-40°C/120°C
PROPIEDADES QUÍMICAS Chemical properties				
ÁCIDOS, DISOLVENTES Acids, Solvents	RESISTENTE (según concentración) Conditionally Consistent	RESISTENTE (según concentración) Conditionally Consistent	RESISTENTE (según concentración) Conditionally Consistent	RESISTENTE (según concentración) Conditionally Consistent
HIDROCARBUROS, ACEITES MINERALES Hydrocarbons, Mineral oils	RESISTENTE (según concentración) Conditionally Consistent	RESISTENTE Consistent	RESISTENTE Consistent	RESISTENTE Consistent
ALCOHOL, AGUA DE MAR, OTROS ACEITES Alcohol, Seawater, Other oils	RESISTENTE Consistent	RESISTENTE Consistent	RESISTENTE Consistent	RESISTENTE Consistent

Abrazaderas Serie ligera TrΔle

Clamps for pipe - TrΔle
Colliers de fixation TrΔle
Collari Serie leggera TrΔle

Plásticos polipropileno, serie ligera

Plastics polypropylene simple, light series

Plastique polypropylene, série légère

Plastica polipropilene serie leggera



DN	GROUP GRUPO	Part n° Referencia	€
6	1	A106C	0,61
8	1	A108C	0,61
10	1	A110C	0,61
12	1	A112C	0,61
1/4"	2	A213.2C	0,63
14	2	A214C	0,63
15	2	A215C	0,63
3/8"	2	A216.7C	0,63
16	2	A216C	0,63
18	2	A218C	0,63
19	3	A319C	0,82
20	3	A320C	0,82
1/2"	3	A321.3C	0,82
22	3	A322C	0,82
23	3	A323C	0,82
25	3	A325C	0,82
3/4"	4	A426.7C	0,99
28	4	A428C	0,99
30	4	A430C	0,99
32	5	A532C	1,50
1"	5	A533.7C	1,50
35	5	A535C	1,50
38	5	A538C	1,50
40	5	A540C	1,50
42	5	A542C	1,50
44.5	6	A644.5C	2,30
1 1/2"	6	A648.3C	2,30
50.8	6	A650.8C	2,30

Precio por pareja / Price per couple / Prix par paire / Prezzo per coppia

Plásticos perfil liso, serie ligera

Plastics smooth profile, light series

Plastique profil lisse, série légère

Plastica profil liscio, serie leggera



GROUP GRUPO	Part n° Referencia	€
1	AL108C	0,61
1	AL110C	0,61
1	AL112C	0,61
2	AL213.2C	0,63
2	AL215C	0,63
2	AL216.7C	0,63
2	AL218C	0,63
3	AL320C	0,82
3	AL321.3C	0,82
3	AL322C	0,82
3	AL325C	0,82
4	AL426.7C	0,99
4	AL428C	0,99
4	AL430C	0,99
5	AL533.3C	1,50
5	AL535C	1,50
5	AL538C	1,50
5	AL542C	1,50

Precio por pareja / Price per couple / Prix par paire / Prezzo per coppia

Cuerpo abrazadera Aluminio, serie ligera

Aluminium clamp body, light series

Corps collier aluminium, série légère

Corpo collare in Alluminio, serie leggera



GROUP GRUPO	Part n° Referencia	€
1	A106AL	*
1	A108AL	*
1	A110AL	*
1	A112AL	*
2	A213.5AL	*
2	A214AL	*
2	A215AL	*
2	A216AL	*
2	A217.2AL	*
2	A218AL	*
3	A319AL	*
3	A320AL	*
3	A321.3AL	*
3	A322AL	*
3	A325AL	*
4	A426.9AL	*
4	A428AL	*
4	A430AL	*
5	A532AL	*
5	A533.7AL	*
5	A535AL	*
5	A538AL	*
5	A540AL	*
5	A542AL	*
6	A648.3AL	*
6	A650.8AL	*

Plásticos para abrazaderas anti-vibración

Plastic for anti-vibration clamps

Plastiques pour colliers de fixation anti-vibratoire

Plastici per collari fissatubo anti-vibrazioni



DN	SERIE	GROUP GRUPO	Part n° Referencia	€
12.7	L	4	AML401270	6,69
14	L	4	AML401400	6,69
19	L	4	AML401900	6,69
22	L	6	AML602200	9,73
28	L	6	AML602800	9,73
30	L	6	AML603000	9,73

Precio por pareja / Price per couple / Prix par paire / Prezzo per coppia

Abrazaderas Serie ligera TrΔle

Clamps for pipe - TrΔle
Colliers de fixation TrΔle
Collari Serie leggera TrΔle

TrΔle Pipe

Pipe Fittings, DIN 2353
/ Flare fittings, JIC 37°

SAE Flanges

TrΔle Clamps

Machines for
processing rigid pipes

Chapas inferiores, serie ligera

Lower plate simple, light series

Plaques inférieures à souder série légère

Piastre inferiori, serie leggera



GROUP GRUPO	Part n° Referencia	€
1	APIN1	0,71
2	APIN2	0,73
3	APIN3	0,82
4	APIN4	0,91
5	APIN5	0,97
6	APIN6	1,15

Tornillos cabeza hexagonal, serie ligera reforzada

Hexagonal bolt, light series reinforced

Vis hexagonale, série légère renforcée

Vite esagonale, serie leggera rinforzata



THREAD ROSCA	GROUP GRUPO	Part n° Referencia	€
M6	1	AVTE1	0,11
M6	2	AVTE2	0,12
M6	3	AVTE3	0,14
M6	4	AVTE4	0,16
M6	5	AVTE5	0,22
M6	6	AVTE6	0,25

Chapa agrupar abrazaderas simples

Jointed plate for simple clamp

Plaque à joindre pour collier simple

Piastre per collare fissatubo singolo



GROUP GRUPO	CLAMP QTY. N° ABRAZADERAS	Part n° Referencia	€
1	10	APAG1	11,47
2	10	APAG2	12,23
3	10	APAG3	12,65

Tornillo apilar ligera

Light serie screw to pile up

Vis pour empiler série légère

Vite per piastra componibili. Serie leggera



THREAD ROSCA	GROUP GRUPO	Part n° Referencia	€
M6	1	AVTA1	2,10
M6	2	AVTA2	2,16
M6	3	AVTA3	2,46
M6	4	AVTA4	2,67
M6	5	AVTA5	3,14

Chapas superiores, serie ligera reforzada

Upper plate, light series reinforced

Plaques supérieures de protection, série légère renforcée

Piastre superiori, serie leggera rinforzata



GROUP GRUPO	Part n° Referencia	€
1	APS1	0,33
2	APS2	0,42
3	APS3	0,46
4	APS4	0,53
5	APS5	0,62
6	APS6	0,75

Tornillos cabeza Allen, serie ligera

Simple Allen bolt, light series

Vis tête six pans creux Allen série légère

Vite Allen, serie leggera



THREAD ROSCA	GROUP GRUPO	Part n° Referencia	€
M6	1	AVTC1	0,11
M6	2	AVTC2	0,13
M6	3	AVTC3	0,14
M6	4	AVTC4	0,17
M6	5	AVTC5	0,23
M6	6	AVTC6	0,23

Chapa atornillar Abr. Simples

Elongated weld plate

Plaque à visser

Piastre per fissaggio



GROUP GRUPO	Part n° Referencia	€
1	APT1	0,91
2	APT2	0,93
3	APT3	0,99
4	APT4	1,06
5	APT5	1,15

Chapa apilar ligera

Light serie plate to pile up

Plaque pour empiler série légère

Piastre componibili. Serie leggera



GROUP GRUPO	Part n° Referencia	€
1	APA1	0,27
2	APA2	0,34
3	APA3	0,42
4	APA4	0,49
5	APA5	0,51
6	APA6	0,63

Abrazaderas Serie doble TrΔle

Clamps double Series - TrΔle
Colliers Serie double TrΔle
Collari Serie doppi TrΔle

Abrazaderas dobles completas

Double clamp - parallel

Colliers de fixation doubles complets

Collare fissatubo doppio completo



DN	GROUP GRUPO	UNITS PER BAG CANTIDAD / BOLSA	Part nº Referencia	€
6	1	10	AZCFS06	1,79
8	1	10	AZCFS08	1,79
10	1	10	AZCFS10	1,79
12	1	10	AZCFS12	1,79
1/4"	2	10	AZCFS13.2	2,47
14	2	10	AZCFS14	2,47
15	2	10	AZCFS15	2,47
16	2	10	AZCFS16	2,47
3/8"	2	10	AZCFS16.7	2,47
18	2	10	AZCFS18	2,47
19	3	10	AZCFS19	2,95
20	3	10	AZCFS20	2,95
1/2"	3	10	AZCFS21.3	2,95
22	3	10	AZCFS22	2,95
25	3	10	AZCFS25	2,95
3/4"	4	10	AZCFS26.7	3,54
28	4	10	AZCFS28	3,54
30	4	10	AZCFS30	3,54
32	5	10	AZCFS32	4,68
1"	5	10	AZCFS33.3	4,68
35	5	10	AZCFS35	4,68
38	5	10	AZCFS38	4,68
40	5	10	AZCFS40	4,68
42	5	10	AZCFS42	4,68

Consultar plásticos en poliamida y aluminio / Polyamide and aluminium plastics, on request /
Plastique polyamide et aluminium, sur demande / Plastica polyamide e alluminio, su richiesta

Chapas inferiores

Double lower plate

Plaques inférieures à souder doubles

Piastre inferiori



THREAD ROSCA	GROUP GRUPO	Part nº Referencia	€
M6	1	ADPIN1	0,84
M8	2	ADPIN2	1,08
M8	3	ADPIN3	1,26
M8	4	ADPIN4	1,44
M8	5	ADPIN5	1,72

Chapas superiores

Double upper plate

Plaques supérieures de protection doubles

Piastre superiori



GROUP GRUPO	Part nº Referencia	€
1	ADPS1	0,33
2	ADPS2	0,42
3	ADPS3	0,51
4	ADPS4	0,64
5	ADPS5	0,82

Tornillos cabeza hexagonal

Double hexagonal bolt

Vis hexagonale

Vite esagonale



THREAD ROSCA	GROUP GRUPO	Part nº Referencia	€
M6	1	ADVTE1	0,13
M8	2	ADVTE2	0,24
M8	3	ADVTE3	0,28
M8	4	ADVTE4	0,33
M8	5	ADVTE5	0,36

Abrazaderas Serie doble TrΔle

Clamps double Series - TrΔle

Colliers Serie double TrΔle

Collari Serie doppi TrΔle

TrΔle Pipe

Pipe Fittings DIN 2353
/ Flare fittings JIC 37°

SAE Flanges

TrΔle Clamps

Machines for
processing rigid pipes

Plásticos polipropileno dobles

Double plastics polypropylene

Double plastiques polypropylene

Plastica polipropilene



DN	GROUP GRUPO	Part n° Referencia	€
6	1	AD106C	0,68
8	1	AD108C	0,68
10	1	AD110C	0,68
12	1	AD112C	0,68
1/4"	2	AD213.2C	0,78
14	2	AD214C	0,78
15	2	AD215C	0,78
3/8"	2	AD216.7C	0,78
16	2	AD216C	0,78
18	2	AD218C	0,78
19	3	AD319C	0,95
20	3	AD320C	0,95
1/2"	3	AD321.3C	0,95
22	3	AD322C	0,95
25	3	AD325C	0,95
3/4"	4	AD426.7C	1,20
28	4	AD428C	1,20
30	4	AD430C	1,20
32	5	AD532C	1,86
1"	5	AD533.3C	1,86
35	5	AD535C	1,86
38	5	AD538C	1,86
40	5	AD540C	1,86
42	5	AD542C	1,86

Precio por pareja / Price per couple / Prix par paire / Prezzo per coppia

Chapa apilar doble

Double series plate to pile up

Plaque pour empiler série double

Piastra componibili. Serie doppia



GROUP GRUPO	Part n° Referencia	€
1	ADPA1	0,44
2/3/4/5	ADPA2	0,44

Chapa agrupar abrazaderas dobles

Jointed plate for double clamp

Plaque à joindre pour collier double

Piastra gruppo per collare fissatubo doppio



THREAD ROSCA	GROUP GRUPO	CLAMP QTY. N° ABRAZADERAS	Part n° Referencia	€
M6	1	5	ADPAG1	4,81
M8	2	2	A2DPIN2	2,64
M8	2	3	A3DPIN2	3,96
M8	2	5	ADPAG2	6,58
M8	3	3	A3DPIN3	5,36
M8	3	5	ADPAG3	7,34

Tornillo apilar doble

Double series screw to pile up

Vis pour empiler série double

Vite per piastra componibili. Serie doppia



THREAD ROSCA	GROUP GRUPO	Part n° Referencia	€
M8	2	ADVTA2	2,61
M8	3	ADVTA3	2,95
M8	4	ADVTA4	3,20

Para Grupo 1: AVTA1 (ligera) / For Group 1: AVTA1 (Light) / Pour le Groupe 1: AVTA1 (légère) / Per il Gruppo 1: AVTA1 (leggera)

Abrazaderas Serie pesada TrΔle

Clamps heavy Series - TrΔle

Colliers Série lourde TrΔle

Collari Serie pesante TrΔle

Abrazadera completa, serie pesada

Heavy clamp, heavy series

Collier de fixation simple complet, série lourde

Collare fissatubo serie pesante completo



DN	GROUP GRUPO	Part n° Referencia	€
6	1	AZCPS06	6,97
8	1	AZCPS08	6,97
10	1	AZCPS10	6,97
12	1	AZCPS12	6,97
1/4"	1	AZCPS13.2	6,97
14	1	AZCPS14	6,97
15	1	AZCPS15	6,97
16	1	AZCPS16	6,97
3/8"	1	AZCPS17.2	6,97
18	1	AZCPS18	6,97
20	2	AZCPS20	7,88
1/2"	2	AZCPS21.3	7,88
22	2	AZCPS22	7,88
25	2	AZCPS25	7,88
3/4"	2	AZCPS26.7	7,88
28	2	AZCPS28	7,88
30	2	AZCPS30	7,88
32	3	AZCPS32	9,25
1"	3	AZCPS33.3	9,25
35	3	AZCPS35	9,25
38	3	AZCPS38	9,25
40	3	AZCPS40	9,25
42	3	AZCPS42	9,25
1"1/4	4	AZCPS42.4	21,33
45	4	AZCPS45	21,33
48-1" 1/2	4	AZCPS48	21,33
1"1/2	4	AZCPS48.4	21,33
50	4	AZCPS50	21,33
55	4	AZCPS55	21,33
60	4	AZCPS60	21,33
2"	4	AZCPS60.3	21,33
65	4	AZCPS65	21,33
70	4	AZCPS70	21,33

Consultar plásticos en poliamida y aluminio / Polyamide and aluminium plastics, on request /
Plastique polyamide et aluminium, sur demande / Plastica polyamide e alluminio, su richiesta

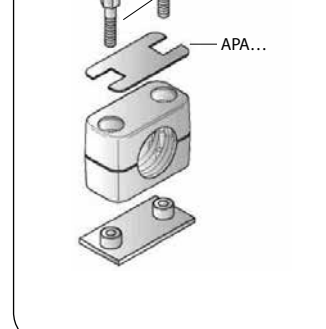
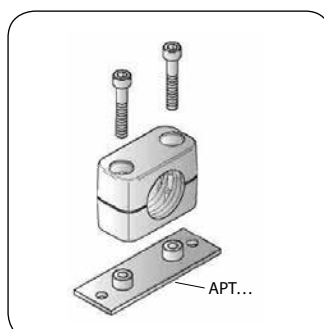
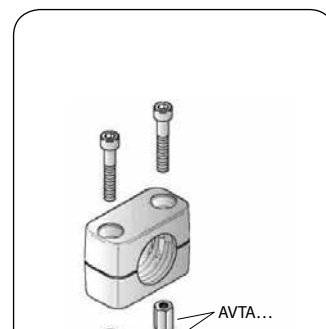
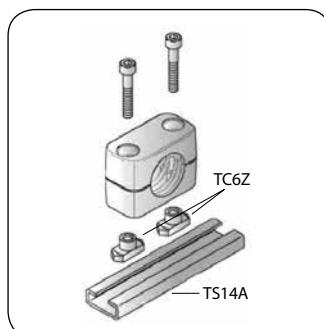
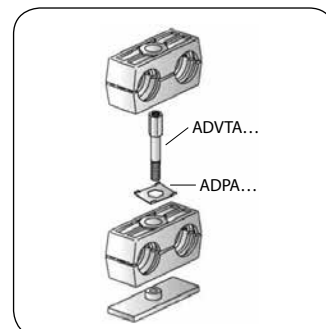
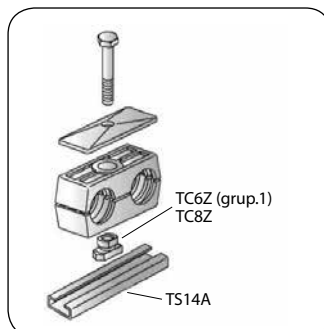
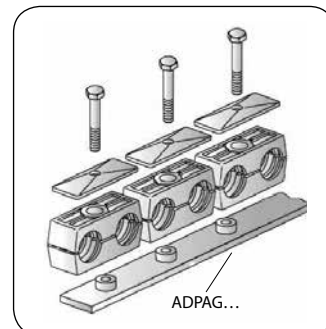
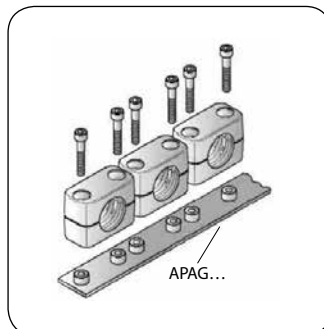

Abrazaderas Serie pesada TrΔle

Clamps heavy Series - TrΔle
Colliers Série lourde TrΔle
Collari Serie pesante TrΔle

Chapas inferiores, serie pesada

Lower plate, heavy series

Plaques inférieures à souder, série lourde

Piastre inferiori, serie pesante



THREAD ROSCA	GROUP GRUPO	Part n° Referencia	€
M10	1	APINP1	2,66
M10	2	APINP2	2,87
M10	3	APINP3	3,12
M12	4	APINP4	6,24

Chapas superiores, serie pesada

Upper plate, heavy series

Plaques supérieures de protection, série lourde

Piastre superiori, serie pesante



GROUP GRUPO	Part n° Referencia	€
1	APSP1	1,14
2	APSP2	1,29
3	APSP3	1,48
4	APSP4	3,63

Tornillos cabeza hexagonal, serie pesada

Hexagonal bolt, heavy series

Vis hexagonale, série lourde

Vite esagonale, serie pesante



THREAD ROSCA	GROUP GRUPO	Part n° Referencia	€
M10	1	AVTEP1	0,53
M10	2	AVTEP2	0,65
M10	3	AVTEP3	0,72
M12	4	AVTEP4	1,37

Plásticos polipropileno, serie pesada

Plastics polypropylene, heavy series

Plastique polypropylene, série lourde

Plastica polipropilene, serie pesante



DN	GROUP GRUPO	Part n° Referencia	€
6	1	AMPP106C	1,62
8	1	AMPP108C	1,62
10	1	AMPP110C	1,62
12	1	AMPP112C	1,62
1/4"	1	AMPP113.2C	1,62
14	1	AMPP114C	1,62
15	1	AMPP115C	1,62
16	1	AMPP116C	1,62
3/8"	1	AMPP117.2C	1,62
18	1	AMPP118C	1,62
20	2	AMPP220C	1,77
1/2"	2	AMPP221.3C	1,77
22	2	AMPP222C	1,77
25	2	AMPP225C	1,77
3/4"	2	AMPP226.7C	1,77
28	2	AMPP228C	1,77
30	2	AMPP230C	1,77
30	3	AMPP330C	2,51
32	3	AMPP332C	2,51
1"	3	AMPP333.3C	2,51
35	3	AMPP335C	2,51
38	3	AMPP338C	2,51
40	3	AMPP340C	2,51
42	3	AMPP342C	2,51
38	4	AMPP438C	7,13
42-1" 1/4	4	AMPP442C	7,13
45	4	AMPP445C	7,13
48-1" 1/2	4	AMPP448C	7,13
50	4	AMPP450C	7,13
55	4	AMPP455C	7,13
2"	4	AMPP460.3C	7,13
65	4	AMPP465C	7,13
70	4	AMPP470C	7,13

Precio por pareja / Price per couple / Prix par paire / Prezzo per coppia

Plásticos para abrazaderas anti-vibración

Plastic for anti-vibration clamps

Plastiques pour colliers de fixation
antivibratoire

Plastici per collari fissatubo anti-vibrazioni, serie
pesante



DN	SERIE	GROUP GRUPO	Part n° Referencia	€
35	S	4	AMS403500	22,71
38	S	4	AMS403800	22,71

Precio por pareja / Price per couple / Prix par paire / Prezzo per coppia

Abrazaderas Serie pesada TrΔle

Clamps heavy Series - TrΔle
 Colliers Série lourde TrΔle
 Collari Serie pesante TrΔle

Chapa apilar Pesada

Heavy series plate to pile up

Plaque pour empiler série lourde

Piastra componibili, serie pesante



GROUP GRUPO	Part n° Referencia	€
1	APAP1	2,34
2	APAP2	2,81
3	APAP3	3,75
4	APAP4	6,09

Tornillo para serie pesada apilable

Screw to pile up heavy series

Vis à empiler série lourde

Vite per serie pesante impilabile



THREAD ROSCA	GROUP GRUPO	Part n° Referencia	€
M10	1	APVTA1	2,61
M10	2	APVTA2	3,10
M10	3	APVTA3	3,71
M12	4	APVTA4	7,25

Accesorios abrazaderas TrΔle

Accessories for clamps - TrΔle

Accessoires colliers TrΔle

Accessori per collari TrΔle

Accesorios carril

Accessories for lane

Accessories pour lane

Accessori per binario



THREAD ROSCA	SIZE TAMAÑO	DESCRIPTION DESCRIPCIÓN	Part nº Referencia	€
M6	--	Rail nut	TC6A	1,69
M8	--	Rail nut	TC8A	5,27
M10	--	Rail nut	TC10A	5,69
M12	--	Rail nut	TC12A	7,17
--	11x28	Mounting rail - 1m	TS11A	9,59
--	14x28	Mounting rail - 1m	TS14A	10,65
--	22x40	Mounting rail - 1m	TSP22	82,61

SERIE LIGERA
LIGHT SERIES



11x28



14x28



SERIE DOBLE
DOUBLE SERIES



GR 2-3-4-5



11x28



14x28



SERIE PESADA
HEAVY SERIES



GR 4



22x40



Máquinas para procesar el tubo rígido

Machines for processing rigid pipes

Machines pour travailler le tube rigide

Macchine per il trattamento del tubo rigido

Máquinas para procesar el tubo rígido

Machines for processing rigid pipes

Machines pour travailler le tube rigide

Macchine per il trattamento del tubo rigido

0

5

Maquinaria para tubo rígido. Desbarbadora

Machines for rigid tube. Deburring machine
Machines pour tube rigide. Machine à ébavurer
Macchine per il tubo rigido. Sbavatore

■ S-01

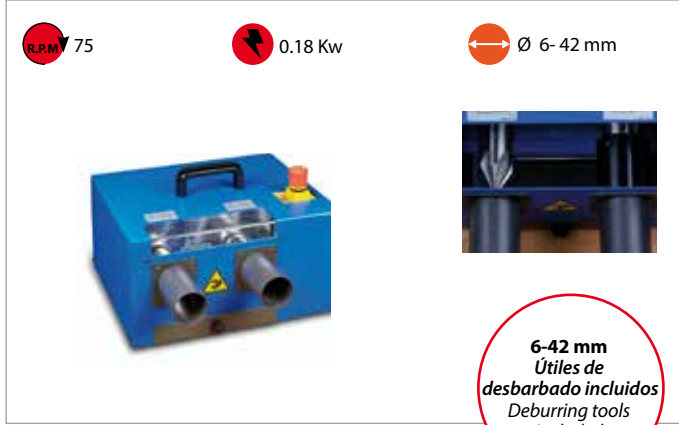

Montaje racores DIN 2353 y JIC 37°/90°

DIN 2353 and JIC 37°/90° pipe fittings assembly
Clontage de raccords DIN 2353 y JIC 37°/90°
Assemblaggio del raccordo ad anello DIN 2353 e JIC 37°/90°

■ USFL/01 MAN



■ USFL/01



Maquinaria para tubo rígido. Dobladoras

Machines for rigid tube. Bending machines
Machines pour tube rigide. Cintreuse
Macchine per il tubo rigido. Curvatubi

■ M18 6-18

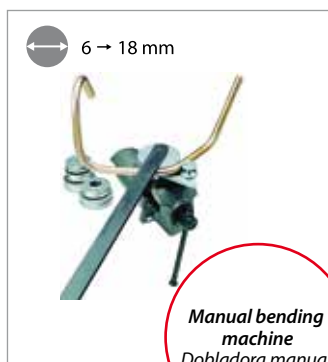

■ CMS42



■ C42

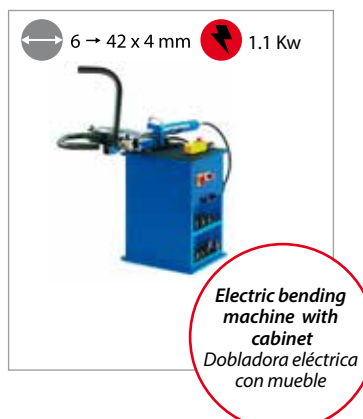

FT37 + BL



PLT + SU



CUC42



Útiles para las máquinas

Machines Accessories
Outils pour machines
Unità multifunzione

Útiles para las máquinas 2 - 3 - 4
Tool for 2 - 3 - 4 machines

Portaherramientas opcional
Tool handler optional

Maquinaria para tubo rígido. Centro de trabajo

Machines for rigid tube. Multi-functional unit
Machines pour tube rigide. Unité multi-fonctions
Macchine per il tubo rigido. Unità multifunzione

Premontaje DIN 2353 24° + Abocardado JIC 37° + Curvatura + Desbarbado
Preassembling DIN 2353 24° + 37° JIC Flaring + Bending + Deburring

6 → 42 x 4 mm

■ CEN-MINI



■ CEN-JU



DICSA



INDUSTRIES DICSA SERVES



DICSA SECTOR INDUSTRIAL



Accesorios

Accessories
Accessoires
Accessori

TrAle®



Adaptadores

Adaptors
Adapteurs
Adattatori

1

Enchufes rápidos

Quick-release couplings
Coupleurs rapides
Innesti rapidi

2

Llaves de paso

Ball valves
Robinets
Rubinetti

3

Desviadores

Diverter
Déviateurs
Deviatori di flusso

4

Racores giratorios

Swivel fittings
Raccords tournants
Raccordi girevoli

5

Multienchufes

Multi-way couplings
Multi-coupleur
Multinnesti rapidi

6

Protecciones

Protections
Protections
Protezioni

7

Adaptadores

Adaptors

Adapteurs

Adattatori

Adaptadores BSP , BSPT y Métricos

286

Metric, BSP and BSPT Adaptors

Adapteurs BSP, BSPT et Métrique

Adattatori BSP , BSPT e Metrico

Adaptadores NPT

302

NPT Adaptors

Adapteurs NPT

Adattatori NPT

Adaptadores ORFS

307

ORFS Adaptors

Adapteurs ORFS

Adattatori ORFS

1

Adaptadores BSP , BSPT y Métricos

Metric, BSP and BSPT Adaptors
Adaptateurs BSP, BSPT et Métrique
Adattatori BSP, BSPT e Metrico

Quick-release couplings

■ Uniones rectas macho / Straight adaptors male / Adapteur droit mâle-mâle / Adattatori diritti maschio | 286

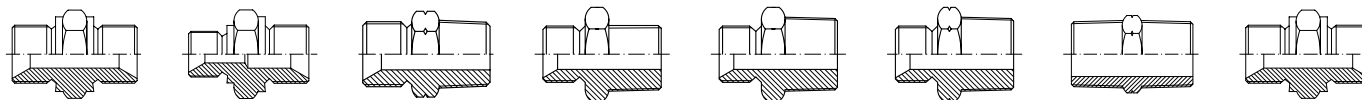

A1010

A1020

S1014

S1012

A1022

A1024

A1016

S1016

Ball valves

■ Uniones rectas macho-hembra / Adaptors male-female / Adapteur mâle-femelle / Adattatori diritti maschio-femmina | 288

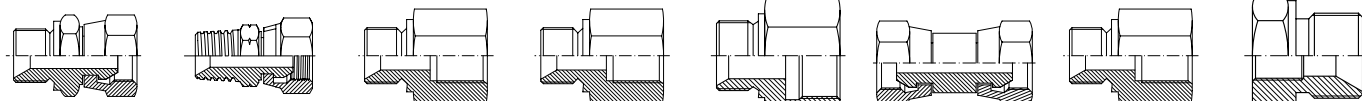

A1170

A1173

A1050

S10610

S106218

A1172 ●

A1060

A1150

Diversers

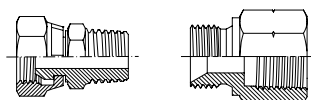

A1171

A1074

Swivel fittings

■ Tapones / Plugs & Caps / Bouchons adapteur / Tappi | 290

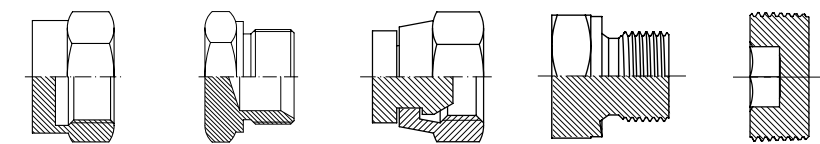

A1072

A1070

A1075

A1073 ●

A1071

Multi-way couplings

■ Uniones hembra y pasatabiques / Adaptors female and bulkheads / Unions femelle et passe cloison / Adattatori femmina e passaparete | 291

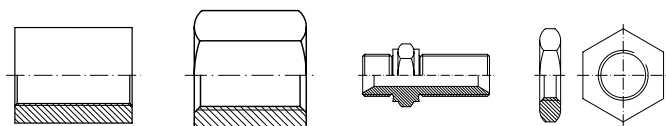

A1310

S10310

A1160

A1272

Protections

■ Orientables / Banjos / Adapteurs banjo / Adattatori a occhio | 292

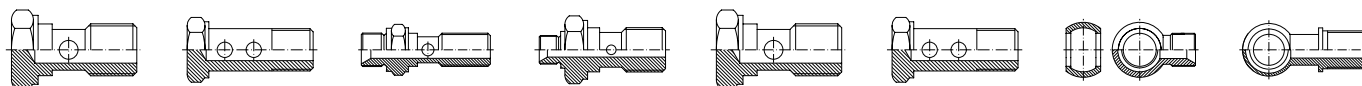

A1090

A1094

A1092

A1093

S1092

A1096

A1140

A1112

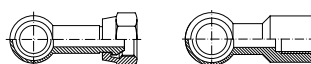

A1111

A1113

■ Soldables / Weldable adaptors / Adapteurs à souder / Adattatori a saldare | 293

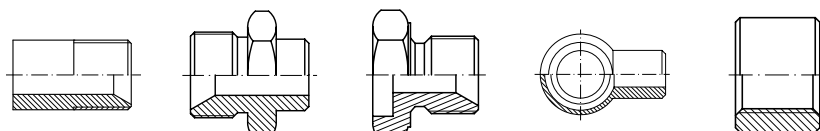

A1290

A1030

A1031

A1141

A1311

Adaptadores BSP , BSPT y Métricos

Metric, BSP and BSPT Adaptors
Adapteurs BSP, BSPT et Métrique
Adattatori BSP, BSPT e Metrico

Codos accesorios (tubo) / Accessorial elbows / Adapteurs coudes / Adattatori a 90° tubolari

294

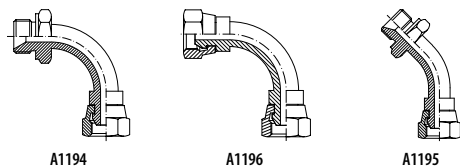

Codos en forja / Forging elbows / Adapteurs coudes en forge / Adattatori a 90° forgiati

295

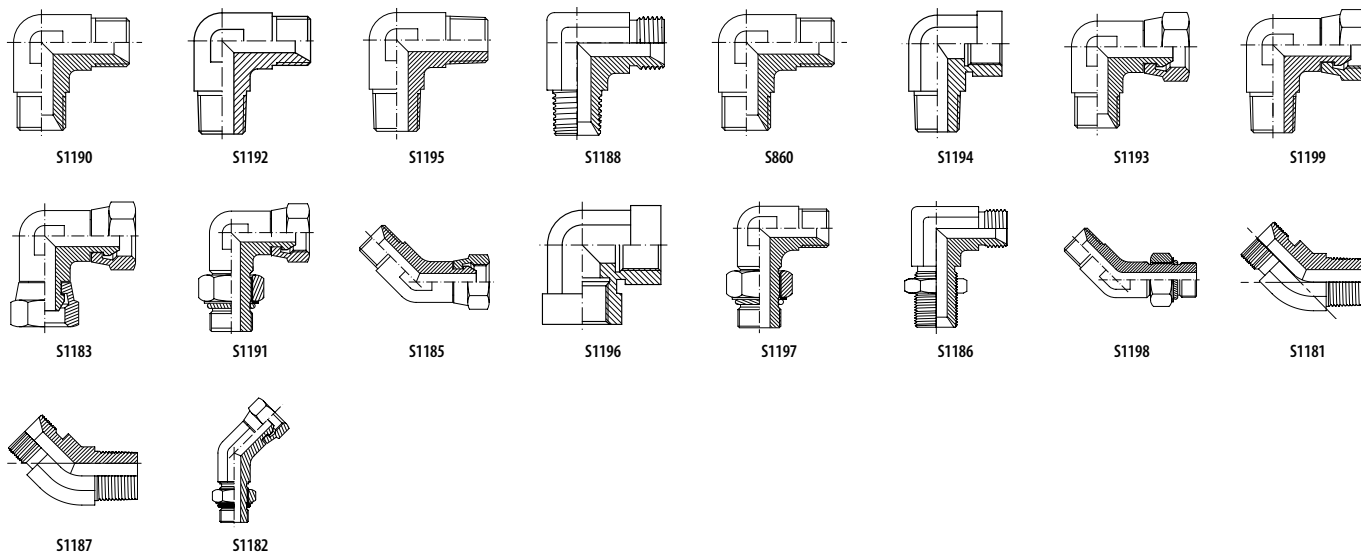

Te en forja y cruz / Forging Tees and croos / Adapteurs Tés en forge et des croix / Adattatori a T forgiati e croce

298

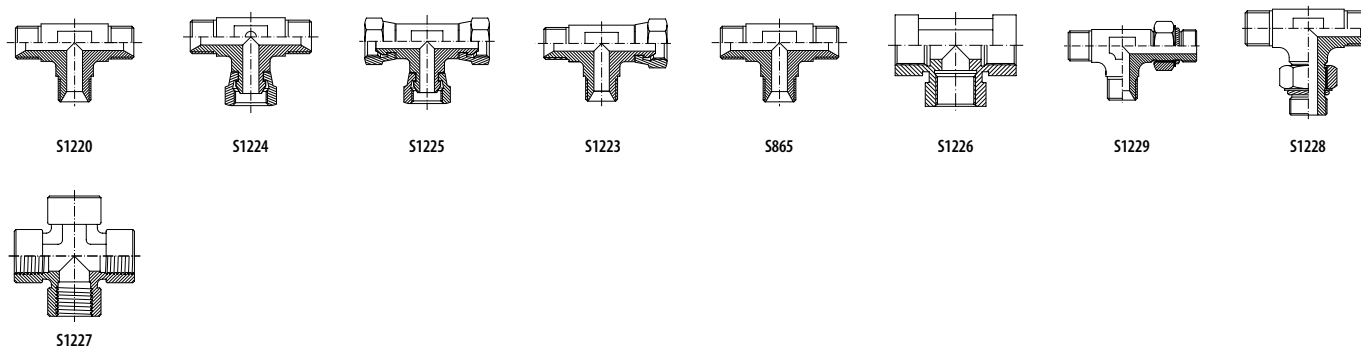

Codos, Te en bloque (cuadrado) y cruz / Square elbows, Tees and cross / Adapteurs coudes. Tés en bloque et des croix / Adattatori a 90°, T da quadro senza saldatura e croce

300

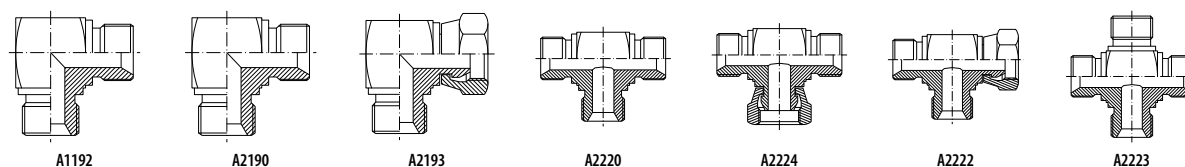

Juntas metal Buna y arandelas / Bonded seals / Bague BS / Rondelle e rondelle Bonded

301

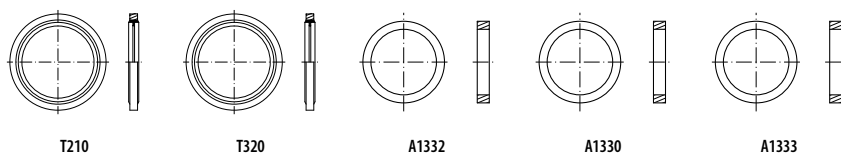

Adaptadores NPT

NPT Adaptors
Adaptateurs NPT
Adattatori NPT

Quick-release couplings

- Uniones rectas macho-macho / Straight adaptors male / Unions mâle / Adattatori diritti maschio - maschio | 302

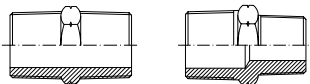

A1015

A1015

Ball valves

- Uniones rectas macho-hembra / Adaptors male-female / Unions mâle-femelle / Adattatori diritti maschio - femmina | 302

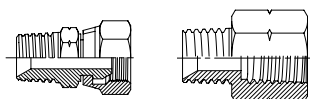

N1170

N1060

Diversers

- Uniones hembra / Adaptors female / Unions femelle / Adattatori femmina | 303

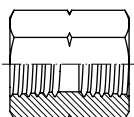

N10310

Swivel fittings

- Tapones / Plugs & Caps / Bouchons / Tappi | 303

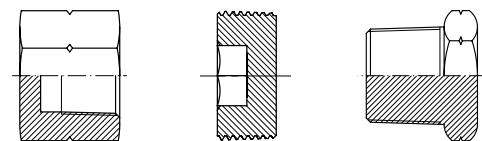

N1072

N1071

N1070

Multi-way couplings

- Codos en forja / Forging elbows / Adapteurs coude en forge / Adattatori a 90° e 45° forgiati | 304

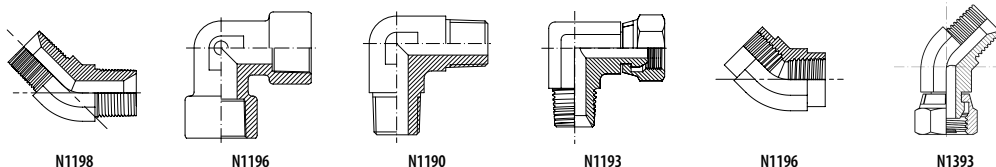

N1198

N1196

N1190

N1193

N1196

N1393

Protections

- Tes en forja / Forging tees / Adapteurs Té en forge / Adattatori a T forgiati | 305

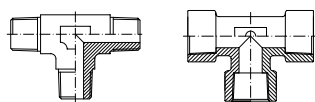

N1220

N1226

Adaptadores ORFS

ORFS Adaptors
 Adapteurs ORFS
 Adattatori ORFS

■ ORFS Rectos / Straight ORFS / ORFS Droits / Raccordi diritti ORFS | 307

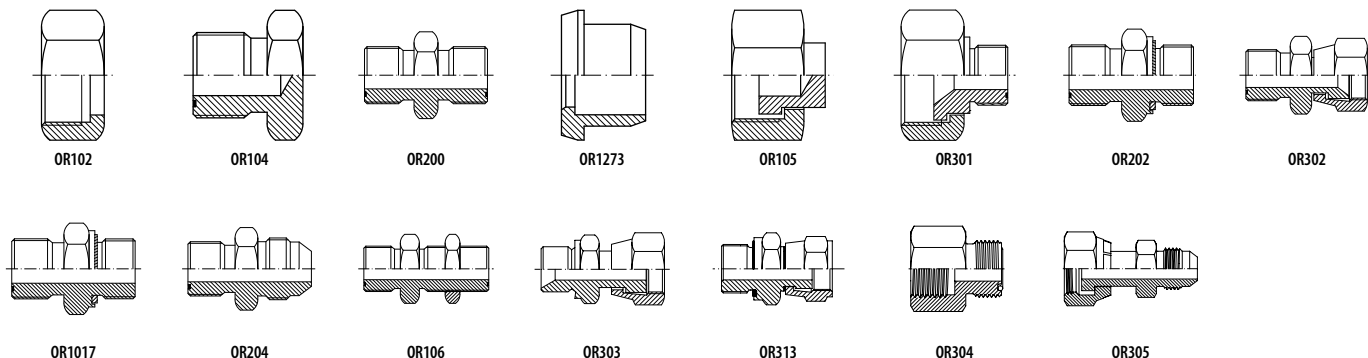

■ Codos 45° ORFS / ORFS 45° Elbows / Coude 45° ORFS / Raccordi a 45° ORFS | 309

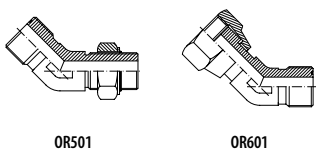

■ Codos 90° ORFS / ORFS 90° Elbows / Coude 90° ORFS / Raccordi a 90° ORFS | 310

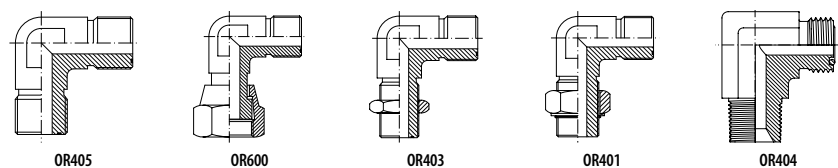

■ Te ORFS / ORFS Tees / Tés ORFS / Raccordi a T ORFS | 311

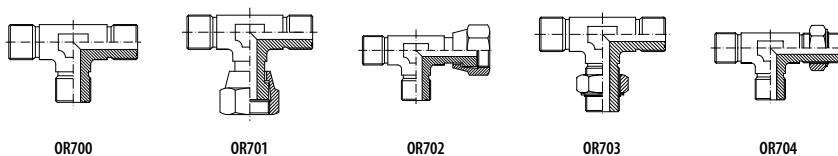

Adaptadores BSP , BSPT y Métricos

Metric, BSP and BSPT Adaptors
Adaptateurs BSP, BSPT et Métrique
Adattatori BSP, BSPT e Metrico

Adaptador macho-macho BSP (60°)

Adaptor BSP male-BSP male (60°)

Adaptateur mâle BSP x mâle BSP (60°)

Niples di giunzione BSP (60°)

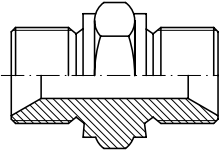

THREAD ROSCA		Part n° Referencia	€
1/8" BSP	1/8" BSP	A101002	0,62
1/4" BSP	1/4" BSP	A101004	0,76
1/4" BSP	1/4" BSP	A101004H19	0,81
3/8" BSP	3/8" BSP	A101006	1,08
1/2" BSP	1/2" BSP	A101008	1,63
5/8" BSP	5/8" BSP	A101010	2,34
3/4" BSP	3/4" BSP	A101012	2,56
1" BSP	1" BSP	A101016	4,75
1"1/4 BSP	1"1/4 BSP	A101020	8,47
1"1/2 BSP	1"1/2 BSP	A101024	12,05
2" BSP	2" BSP	A101032	20,63
2" 1/2 BSP	2" 1/2 BSP	A101040	40,85
3" BSP	3" BSP	A101048	59,42

Reductor macho-macho BSP (60°)

Reducer adaptor BSP male-BSP male (60°)

Reducteur mâle BSP x mâle BSP (60°)

Niples di riduzione BSP (60°)

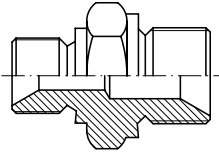

THREAD ROSCA		Part n° Referencia	€
1/8" BSP	1/4" BSP	A10200204	0,94
1/8" BSP	3/8" BSP	A10200206	1,52
1/4" BSP	3/8" BSP	A10200406	1,25
1/4" BSP	1/2" BSP	A10200408	1,72
3/8" BSP	1/2" BSP	A10200608	1,56
3/8" BSP	3/4" BSP	A10200612	2,64
1/2" BSP	3/4" BSP	A10200812	2,62
1/2" BSP	1" BSP	A10200816	4,82
5/8" BSP	1/2" BSP	A10201008	2,94
5/8" BSP	3/4" BSP	A10201012	3,05
3/4" BSP	1" BSP	A10201216	4,83
3/4" BSP	1"1/4 BSP	A10201220	7,06
1" BSP	1"1/4 BSP	A10201620	8,32
1" BSP	1"1/2 BSP	A10201624	13,07
1"1/4 BSP	1"1/2 BSP	A10202024	10,69
1"1/4 BSP	2" BSP	A10202032	22,23
1"1/2 BSP	2" BSP	A10202432	20,24
2" BSP	2" 1/2 BSP	A10203240	40,85
2" BSP	3" BSP	A10203248	64,02
2" 1/2 BSP	3" BSP	A10204048	59,42

Adaptador macho BSP (60°) - macho NPT

Adaptor BSP male (60°)-NPT male

Adaptateur mâle BSP (60°) x mâle briggs (NPT)

Niples di congiunzione BSP (60°) - NPT

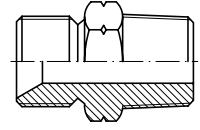

THREAD ROSCA		Part n° Referencia	€
1/8" BSP	1/8" NPT	S101402	1,11
1/4" BSP	1/4" NPT	S101404	1,29
3/8" BSP	3/8" NPT	S101406	1,45
1/2" BSP	1/2" NPT	S101408	2,70
3/4" BSP	3/4" NPT	S101412	4,12
1" BSP	1" NPT	S101416	8,68
1"1/4 BSP	1"1/4 NPT	S101420	17,28
1"1/2 BSP	1"1/2 NPT	S101424	21,77
2" BSP	2" NPT	S101432	45,19

Adaptador macho BSP (60°) - macho BSPT

Adaptor BSP male- 60° BSPT male

Adaptateur mâle BSP (60°) x mâle gaz conique (BSPT)

Niples di congiunzione BSP (60°) - BSPT

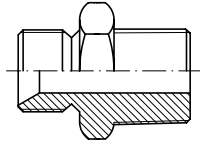

THREAD ROSCA		Part n° Referencia	€
1/8" BSP	1/8" BSPT	S101202	1,22
1/4" BSP	1/4" BSPT	S101204	0,99
3/8" BSP	3/8" BSPT	S101206	1,14
1/2" BSP	1/2" BSPT	S101208	1,58
3/4" BSP	3/4" BSPT	S101212	2,89
1" BSP	1" BSPT	S101216	5,45
1"1/4 BSP	1"1/4 BSPT	S101220	11,63
1"1/2 BSP	1"1/2 BSPT	S101224	13,89
2" BSP	2" BSPT	S101232	27,15

Reductor macho BSP (60°) - macho BSPT

Reducer adaptor BSP male (60°)-BSPT male

Reducteur mâle BSP (60°) x mâle gaz conique (BSPT)

Niples di riduzione BSP (60°) - BSPT

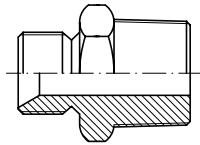

THREAD ROSCA		Part n° Referencia	€
1/4" BSP	3/8" BSPT	A10220406	2,33
3/8" BSP	1/2" BSPT	A10220608	3,33
3/8" BSP	3/4" BSPT	A10220612	4,41
1/2" BSP	1/4" BSPT	A10220804	3,94
1/2" BSP	3/4" BSPT	A10220812	5,74
3/4" BSP	1" BSPT	A10221216	7,37
1"1/4 BSP	1" BSPT	A10222016	16,98
1"1/2 BSP	2" BSPT	A10222432	49,55

Adaptadores BSP , BSPT y Métricos

Metric, BSP and BSPT Adaptors
Adaptateurs BSP, BSPT et Métrique
Adattatori BSP, BSPT e Metrico

Reductor macho BSP (60°) - macho NPT

Reducer adaptor BSP male (60°)-NPT male

Reducteur mâle BSP (60°) x mâle briggs (NPT)

Niples di riduzione BSP (60°) - NPT

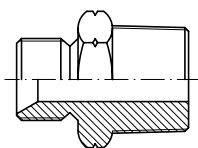

THREAD ROSCA		Part n° Referencia	€
1/4" BSP	1/8" NPT	A10240402	2,33
1/4" BSP	3/8" NPT	A10240406	2,64
1/4" BSP	1/2" NPT	A10240408	3,88
3/8" BSP	1/2" NPT	A10240608	3,31
1/2" BSP	3/8" NPT	A10240806	4,18
1/2" BSP	3/4" NPT	A10240812	6,14
3/4" BSP	1/2" NPT	A10241208	7,13
3/4" BSP	1" NPT	A10241216	6,18

Adaptador macho-macho BSPT

Adaptor BSPT male-BSPT male

Adaptateur mâle gaz conique (BSPT) x mâle gaz conique (BSPT)

Niples di congiunzione BSPT

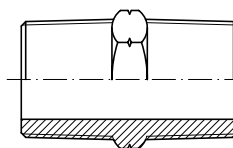

THREAD ROSCA		Part n° Referencia	€
1/4" BSPT	1/4" BSPT	A10160404	1,02
3/8" BSPT	3/8" BSPT	A10160606	2,31
1/2" BSPT	1/2" BSPT	A10160808	2,95
3/4" BSPT	3/4" BSPT	A10161212	4,96
1" BSPT	1" BSPT	A10161616	6,33

Adaptador macho-macho Métrico (60°)

Adaptor Metric male-male (60°)

Adaptateur mâle DIN x mâle DIN Métrique (60°)

Niples di giunzione Metrico (60°)

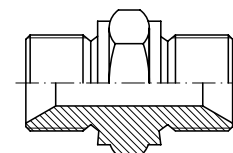

THREAD ROSCA		Part n° Referencia	€
M12x1.5	M12x1.5	S101612	2,23
M14x1.5	M14x1.5	S101614	1,66
M16x1.5	M16x1.5	S101616	1,73
M18x1.5	M18x1.5	S101618	1,98
M22x1.5	M22x1.5	S101622	3,16
M26x1.5	M26x1.5	S101626	5,57

Adaptadores BSP , BSPT y Métricos

Metric, BSP and BSPT Adaptors
Adaptateurs BSP, BSPT et Métrique
Adattatori BSP, BSPT e Metrico

Adap. macho - hembra giratoria BSP (60°)

Adaptor BSP male-BSP swivel female (60°)

Adaptateur mâle BSP x femelle tournante BSP (60°)

Nipples maschio-femmina girevole BSP (60°)

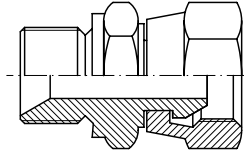

THREAD ROSCA		Part nº Referencia	€
1/8" BSP	1/8" BSP	A117002	2,79
1/4" BSP	1/4" BSP	A117004	2,16
3/8" BSP	3/8" BSP	A117006	2,23
1/2" BSP	1/2" BSP	A117008	3,44
3/4" BSP	3/4" BSP	A117012	4,87
1" BSP	1" BSP	A117016	9,10
1"1/4 BSP	1"1/4 BSP	A117020	19,13
1"1/2 BSP	1"1/2 BSP	A117024	23,51
2" BSP	2" BSP	A117032	47,41

Reductor macho - hembra giratoria BSP (60°)

Reducer BSP male-BSP swivel female (60°)

Reducteur mâle BSP x femelle tournante BSP (60°)

Nipples di riduzione maschio-femmina girevole BSP (60°)

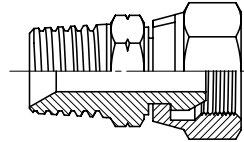

THREAD ROSCA		Part nº Referencia	€
M 1/8" BSP	F 1/4" BSP	A11730204	2,59
M 1/4" BSP	F 1/8" BSP	A11730402	2,29
M 1/4" BSP	F 3/8" BSP	A11730406	2,59
M 3/8" BSP	F 1/4" BSP	A11730604	2,86
M 1/2" BSP	F 3/8" BSP	A11730806	3,95
M 3/4" BSP	F 1/2" BSP	A11731208	5,66
M 1" BSP	F 3/4" BSP	A11731612	7,73
M 3/8" BSP	F 1/2" BSP	A11730608	3,30
M 1/2" BSP	F 3/4" BSP	A11730812	4,39
M 3/4" BSP	F 1" BSP	A11731216	8,10
M 3/4" BSP	F 1"1/4 BSP	A11731220	13,73
M 1" BSP	F 1"1/4 BSP	A11731620	18,99
M 1"1/4 BSP	F 1"1/2 BSP	A11732024	36,00
M 1" 1/2 BSP	F 2" BSP	A11732432	52,49

Prolongador macho (60°) - hembra fija BSP

Adaptor BSP male (60°) - BSP fixed female

Prolongateur mâle BSP (60°) x femelle gaz fixe

Prolunga maschio (60°) - femmina BSP

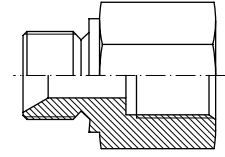

THREAD ROSCA		Part nº Referencia	€
1/8" BSP	1/8" BSP	A105002	0,81
1/8" BSP	1/8" BSP	A105002L38	1,41
1/4" BSP	1/4" BSP	A105004	1,08
1/4" BSP	1/4" BSP	A105004L46	2,15
1/4" BSP	1/4" BSP	A105004L56	2,01
3/8" BSP	3/8" BSP	A105006	1,43
3/8" BSP	3/8" BSP	A105006L44	2,38
3/8" BSP	3/8" BSP	A105006L54	2,97
1/2" BSP	1/2" BSP	A105008	2,29
1/2" BSP	1/2" BSP	A105008L50	2,89
1/2" BSP	1/2" BSP	A105008L60	3,10
3/4" BSP	3/4" BSP	A105012	3,22
3/4" BSP	3/4" BSP	A105012L72	5,94
1" BSP	1" BSP	A105016	5,06
1" BSP	1" BSP	A105016L84	10,77
1"1/4 BSP	1"1/4 BSP	A105020	10,79
1"1/4 BSP	1"1/4 BSP	A105020L92	14,85
1"1/2 BSP	1"1/2 BSP	A105024	14,85
1"1/2 BSP	1"1/2 BSP	A105024L100	22,28
2" BSP	2" BSP	A105032	24,10
2" BSP	2" BSP	A105032L100	34,91

Reductor macho BSP (60°) - hembra fija Métrica

Reducer adaptor BSP male (60°) - Metric fixed female

Reducteur mâle BSP (60°) x femelle fixe Métrique

Nipples di riduzione maschio BSP (60°)-femmina fissa Metrica

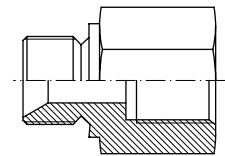

THREAD ROSCA		Part nº Referencia	€
3/8" BSP	M14x1.5	S10610614	3,96
3/8" BSP	M18x1.5	S10610618	3,29
1/2" BSP	M18x1.5	S10610818	3,91
1/2" BSP	M22x1.5	S10610822	3,91

Reductor macho métrico (60°) - hembra fija BSP

Reducer adaptor Metric male - BSP fixed female

Reducteur mâle Métrique (60°) x femelle fixe gaz

Nipples di riduzione maschio Metrico (60°)-femmina fissa BSP

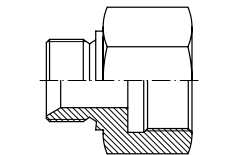

THREAD ROSCA		Part nº Referencia	€
M18x1.5	1/4" BSP	S10621804	3,89
M18x1.5	3/8" BSP	S10621806	3,89
M18x1.5	1/2" BSP	S10621808	4,49

Adaptadores BSP , BSPT y Métricos

Metric, BSP and BSPT Adaptors
Adaptateurs BSP, BSPT et Métrique
Adattatori BSP, BSPT e Metrico

Adap. hembra giratoria - hembra giratoria BSP (60°)

Adaptor BSP swivel female - BSP swivel female (60°)

Adaptateur femelle tournante BSP x femelle tournante BSP (60°)

Nipples feminas-femmina girevole BSP (60°)

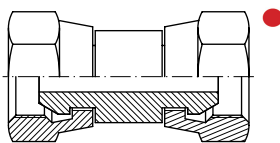

THREAD ROSCA		Part nº Referencia	€
1/4" BSP	1/4" BSP	A117204	2,90
3/8" BSP	3/8" BSP	A117206	3,59
1/2" BSP	1/2" BSP	A117208	5,66
3/4" BSP	3/4" BSP	A117212	7,24
1" BSP	1" BSP	A117216	11,76
1"1/4 BSP	1"1/4 BSP	A117220	36,75
1"1/2 BSP	1"1/2 BSP	A117224	53,77
2" BSP	2" BSP	A117232	133,18

Reductor macho BSP (60°) - hembra fija BSP

Reducer adaptor BPS male (60°) - BSP fixed female

Prolongateur reducteur mâle BSP (60°) x femelle gaz fixe

Prolunga di riduzione maschio (60°) - femmina BSP

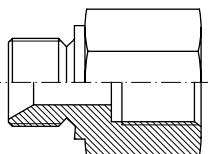

THREAD ROSCA		Part nº Referencia	€
M 1/8" BSP	F 1/4" BSP	A10600204	1,24
M 1/8" BSP	F 3/8" BSP	A10600206	2,07
M 1/4" BSP	F 1/8" BSP	A10600402	1,23
M 1/4" BSP	F 3/8" BSP	A10600406	1,71
M 1/4" BSP	F 1/2" BSP	A10600408	2,41
M 3/8" BSP	F 1/8" BSP	A10600602	2,55
M 3/8" BSP	F 1/4" BSP	A10600604	1,65
M 3/8" BSP	F 1/2" BSP	A10600608	2,24
M 3/8" BSP	F 3/4" BSP	A10600612	3,10
M 1/2" BSP	F 1/4" BSP	A10600804	2,86
M 1/2" BSP	F 3/8" BSP	A10600806	2,27
M 1/2" BSP	F 3/4" BSP	A10600812	3,17
M 1/2" BSP	F 1" BSP	A10600816	5,72
M 3/4" BSP	F 3/8" BSP	A10601206	3,73
M 3/4" BSP	F 1/2" BSP	A10601208	3,42
M 3/4" BSP	F 1" BSP	A10601216	5,85
M 3/4" BSP	F 1"1/4 BSP	A10601220	10,93
M 1" BSP	F 1/2" BSP	A10601608	5,51
M 1" BSP	F 3/4" BSP	A10601612	5,65
M 1" BSP	F 1"1/4 BSP	A10601620	10,29
M 1"1/4 BSP	F 1" BSP	A10602016	10,93
M 1"1/4 BSP	F 1" 1/2 BSP	A10602024	15,60
M 1"1/2 BSP	F 1"1/4 BSP	A10602420	27,41
M 1"1/2 BSP	F 2" BSP	A10602432	60,94

Tapón reductor macho (60°) - hembra fija BSP

Reducer plug BSP male (60°) - BSP fixed female

Bouchon reducteur mâle BSP (60°) x femelle gaz fixe

Tappo di riduzione maschio (60°) - femmina BSP

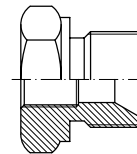

THREAD ROSCA		Part nº Referencia	€
M 1/4" BSP	F 1/8" BSP	A11500402	1,00
M 3/8" BSP	F 1/8" BSP	A11500602	1,49
M 3/8" BSP	F 1/4" BSP	A11500604	1,05
M 1/2" BSP	F 1/4" BSP	A11500804	1,75
M 1/2" BSP	F 3/8" BSP	A11500806	1,61
M 3/4" BSP	F 3/8" BSP	A11501206	2,21
M 3/4" BSP	F 1/2" BSP	A11501208	2,65
M 1" BSP	F 1/2" BSP	A11501608	3,69
M 1" BSP	F 3/4" BSP	A11501612	3,51
M 1"1/4 BSP	F 3/4" BSP	A11502012	6,85
M 1"1/4 BSP	F 1" BSP	A11502016	6,01
M 1"1/2 BSP	F 1"1/4 BSP	A11502420	10,10
M 2" BSP	F 1" 1/4 BSP	A11503220	24,52
M 2" BSP	F 1"1/2 BSP	A11503224	24,52

Adaptador hembra giratoria BSP (60°) - Macho BSPT

Adaptor BSP swivel female (60°) - BSPT male

Adaptateur femelle tournante BSP (60°) x mâle BSPT

Nipples femmina girevole BSP (60°)-maschio BSPT

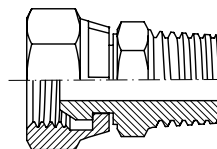

THREAD ROSCA		Part nº Referencia	€
M 1/4" BSPT	F 1/4" BSP	A11710404	4,35
M 3/8" BSPT	F 3/8" BSP	A11710606	4,73
M 1/2" BSPT	F 1/2" BSP	A11710808	6,05
M 3/4" BSPT	F 3/4" BSP	A11711212	9,46
M 1" BSPT	F 1" BSP	A11711616	15,20

Adaptador macho BSP (60°) - Hembra Fija NPT

Adaptor BSP male (60°) - NPT fixed female

Adaptateur mâle BSP (60°) x femelle fixe NPT

Nipples di riduzione maschio (60°) - femmina NPT

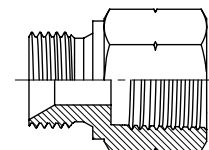

THREAD ROSCA		Part nº Referencia	€
M 1/4" BSP	F 1/4" NPT	A107404	2,66
M 3/8" BSP	F 3/8" NPT	A107406	3,62
M 1/2" BSP	F 1/2" NPT	A107408	5,43
M 3/4" BSP	F 3/4" NPT	A107412	8,14
M 1" BSP	F 1" NPT	A107416	12,07

Adaptadores BSP , BSPT y Métricos

Metric, BSP and BSPT Adaptors
Adaptateurs BSP, BSPT et Métrique
Adattatori BSP, BSPT e Metrico

Tapón hembra hexagonal rosca BSP

BSP fixed cap

Bouchon femelle gaz

Tappo femmina fissa BSP

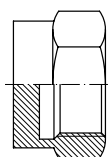

THREAD ROSCA	Part nº Referencia	€
1/8" BSP	A107202	1,38
1/4" BSP	A107204	1,17
3/8" BSP	A107206	1,45
1/2" BSP	A107208	2,08
3/4" BSP	A107212	2,78
1" BSP	A107216	4,52
1"1/4 BSP	A107220	13,48
1"1/2 BSP	A107224	30,21
2" BSP	A107232	45,68

Tapón macho hexagonal rosca BSP (60°)

BSP hexagonal male plug (60°)

Bouchon mâle BSP (60°)

Tappo maschio esagonale BSP (60°)

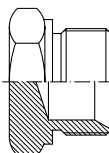

THREAD ROSCA	Part nº Referencia	€
1/8" BSP	A107002	0,66
1/4" BSP	A107004	0,75
1/4" BSP	A107004H19	0,77
3/8" BSP	A107006	1,04
1/2" BSP	A107008	1,51
5/8" BSP	A107010	2,90
3/4" BSP	A107012	2,16
1" BSP	A107016	3,86
1"1/4 BSP	A107020	8,71
1"1/2 BSP	A107024	11,42
2" BSP	A107032	17,87

Tapón hembra giratoria BSP (60°)

BSP swivel female cap (60°)

Bouchon femelle tournante BSP (60°)

Tappo femmina girevole BSP (60°)

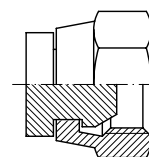

THREAD ROSCA	Part nº Referencia	€
1/4" BSP	A107504	1,46
3/8" BSP	A107506	1,73
1/2" BSP	A107508	2,39
3/4" BSP	A107512	3,23
1" BSP	A107516	4,83
1"1/4 BSP	A107520	12,48
1"1/2 BSP	A107524	18,14
2" BSP	A107532	30,01

Tapón macho hexagonal rosca Métrica

Metric hexagonal male plug

Bouchon mâle Métrique

Tappo maschio esagonale Metrico

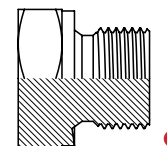

THREAD ROSCA	Part nº Referencia	€
M10x1	A10731001	0,78
M12x1.5	A10731215	0,98
M14x1.5	A10731415	0,91
M16x1.5	A10731615	1,17
M18x1.5	A10731815	1,51
M20x1.5	A10732015	1,58
M22x1.5	A10732215	1,56

Tapón Allen BSPT sin cabeza

BSPT blanking plug

Bouchon Allen BSPT

Tappo conico BSPT

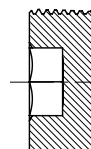

THREAD ROSCA	Part nº Referencia	€
1/8" BSPT	A107102	0,65
1/4" BSPT	A107104	0,88
3/8" BSPT	A107106	1,17
1/2" BSPT	A107108	1,56
3/4" BSPT	A107112	2,81
1" BSPT	A107116	3,50

Adaptadores BSP , BSPT y Métricos

Metric, BSP and BSPT Adaptors
Adaptateurs BSP, BSPT et Métrique
Adattatori BSP, BSPT e Metrico

Manguito roscado hembra BSP redondo soldable

Welding adaptor BSP female fixed-BSP female fixed

Manchon femelle à souder gaz x femelle gaz ronde

Manicoto femmina - femmina a saldare BSP

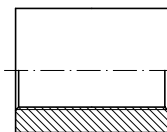

THREAD ROSCA	Part nº Referencia	€
1/8" BSP	A131002	0,94
1/4" BSP	A131004	1,13
3/8" BSP	A131006	1,53
1/2" BSP	A131008	2,13
3/4" BSP	A131012	2,97
1" BSP	A131016	4,39
1"1/4 BSP	A131020	7,17
1"1/2 BSP	A131024	9,68
2" BSP	A131032	14,73

Manguito roscado hembra BSP hexagonal

Hexagonal adaptor BSP fixed female-BSP fixed female

Manchon femelle gaz x femelle gaz hexagonal

Prolunga esagonale femmina-femmina BSP

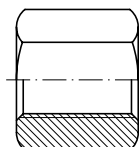

THREAD ROSCA	Part nº Referencia	€
1/4" BSP	S1031004	0,97
3/8" BSP	S1031006	2,00
1/2" BSP	S1031008	2,15
3/4" BSP	S1031012	3,47
1" BSP	S1031016	4,13
1"1/4 BSP	S1031020	15,45
1"1/2 BSP	S1031024	19,31

Pasatabiques sin tuerca BSP cono 60°

Straight bulkhead adaptor without nuts (60°)

Passe-cloison mâle BSP x mâle BSP sans équiper (60°)

Nipples passaparete BSP

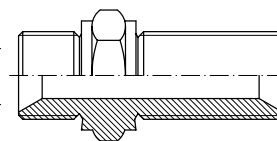

THREAD ROSCA		Part nº Referencia	€
1/4" BSP	1/4" BSP	A116004	1,77
3/8" BSP	3/8" BSP	A116006	2,15
1/2" BSP	1/2" BSP	A116008	3,12
3/4" BSP	3/4" BSP	A116012	5,38
1" BSP	1" BSP	A116016	8,77
1"1/4 BSP	1"1/4 BSP	A116020	13,50
1"1/2 BSP	1"1/2 BSP	A116024	15,70

Tuerca pasatabiques BSP

Counter nut for bulkhead screw-joints

Contre-écrou passe-cloison gaz

Controdado per passaparete BSP

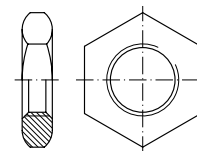

THREAD ROSCA	Part nº Referencia	€
1/8" BSP	A127202	1,30
1/4" BSP	A127204	0,48
3/8" BSP	A127206	0,68
1/2" BSP	A127208	0,95
3/4" BSP	A127212	1,18
1" BSP	A127216	2,87
1" 1/4 BSP	A127220	4,13
1" 1/2 BSP	A127224	4,62

Adaptadores BSP , BSPT y Métricos

Metric, BSP and BSPT Adaptors
Adaptateurs BSP, BSPT et Métrique
Adattatori BSP, BSPT e Metrico

Tornillo orientable simple BSP

BSP Bolt for banjo

Vis creuse simple pour banjo filetage gaz

Bullone forato BSP

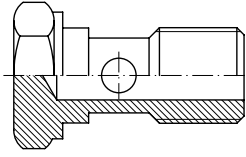

THREAD ROSCA	Part nº Referencia	€
1/8" BSP	A109002	1,14
1/4" BSP	A109004	1,14
3/8" BSP	A109006	1,45
1/2" BSP	A109008	2,23
5/8" BSP	A109010	2,60
3/4" BSP	A109012	3,87
1" BSP	A109016	6,27
1 1/4" BSP	A109020	34,18
1 1/2" BSP	A109024	87,21

Tornillo orientable doble BSP

BSP Double bolt for banjo

Vis creuse double pour banjo filetage gaz

Bullone forato doppio BSP

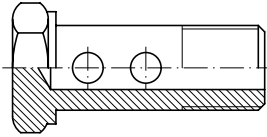

THREAD ROSCA	Part nº Referencia	€
1/4" BSP	A109404	2,42
3/8" BSP	A109406	2,93
1/2" BSP	A109408	4,71
3/4" BSP	A109412	8,46
1" BSP	A109416	17,61

Tornillo orientable prolongado BSP

BSP Extended bolt for banjo

Vis creuse simple prolongée pour banjo

Bullone forato prolungato BSP

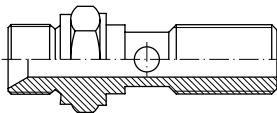

THREAD ROSCA	Part nº Referencia	€	
1/4" BSP	1/4" BSP	A109204	2,89
3/8" BSP	3/8" BSP	A109206	3,70
1/2" BSP	1/2" BSP	A109208	5,03
3/4" BSP	3/4" BSP	A109212	7,19
1" BSP	1" BSP	A109216	14,27

Tornillo orientable reductor BSP

BSP Reducer bolt for banjo

Vis creuse simple reduite pour banjo x mâle BSP

Bullone forato di riduzione BSP

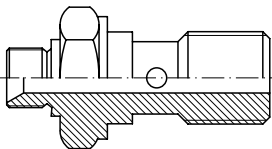

THREAD ROSCA	Part nº Referencia	€	
1/4" BSP	3/8" BSP	A10930406	3,70
3/8" BSP	1/2" BSP	A10930608	5,03
1/2" BSP	3/4" BSP	A10930812	7,19
3/4" BSP	1" BSP	A10931216	14,27

Tornillo orientable simple rosca Métrica

Metric bolt for banjo

Vis creuse simple pour banjo filetage Métrique

Bullone forato Metrico

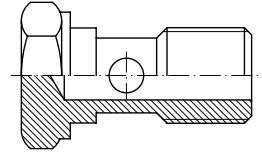

THREAD ROSCA	Part nº Referencia	€
M8x1	S109208	1,03
M10x1	S109210	1,03
M12x1.5	S109212	1,17
M14x1.5	S109214	1,38
M16x1.5	S109216	1,76
M18x1.5	S109218	1,84
M22x1.5	S109222	2,45
M26x1.5	S109226	4,04
M30x1.5	S109230	8,72

Tornillo orientable doble rosca Métrica

Metric double bolt for banjo

Vis creuse double pour banjo filetage Métrique

Bullone forato doppio Metrico

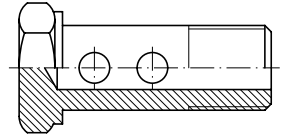

THREAD ROSCA	Part nº Referencia	€
M8x1	A10960801	2,96
M10x1	A10961001	1,91
M12x1.5	A10961215	3,49
M14x1.5	A10961415	2,83
M18x1.5	A10961815	4,85

Esférico BSP - macho BSP (60°)

BSP Banjo-BSP male (60°)

Banjo passage gaz x mâle BSP (60°)

Adattatore ad ochhio filettato BSP

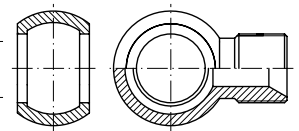

THREAD ROSCA	Ø	Part nº Referencia	€
1/8" BSP	1/8"	A114002	3,08
1/4" BSP	1/4"	A114004	2,00
3/8" BSP	3/8"	A114006	3,21
1/2" BSP	1/2"	A114008	3,71
3/4" BSP	3/4"	A114012	10,85
1" BSP	1"	A114016	37,28

Esférico BSP con alargadera-macho BSP (60°)

BSP Banjo with extension-BSP male 60°

Banjo prolongé passage gaz x mâle BSP 60°

Adattatore ad occhio con prolunga maschio 60°

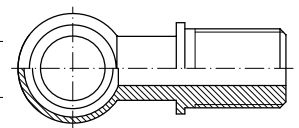

THREAD ROSCA	Ø	Part nº Referencia	€
3/8" BSP	3/8"	A111206	6,31
1/2" BSP	3/8"	A11120608	12,09
1/2" BSP	1/2"	A111208	12,11

Adaptadores BSP , BSPT y Métricos

Metric, BSP and BSPT Adaptors
Adaptateurs BSP, BSPT et Métrique
Adattatori BSP, BSPT e Metrico

Adaptors

Quick-release couplings

Ball valves

Diverters

Swivel fittings

Multi-way couplings

Protections

Esférico BSP con alargadera-hembra giratoria BSP

BSP Banjo with extension-BSP swivel female

Banjo prolongé passage gaz femelle tournante

Adattatore ad occhio con prolunga femmina girevole

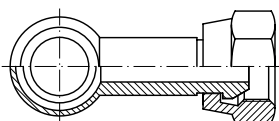

THREAD ROSCA	Ø	Part n° Referencia	€
1/2" BSP	1/2"	A111108	15,56

Esférico BSP con alargadera-hembra fija BSP

BSP Banjo with extension-BSP fixed female

Banjo prolongé passage gaz x femelle fixe BSP

Adattatore ad occhio con prolunga femmina fissa

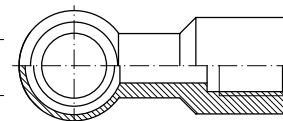

THREAD ROSCA	Ø	Part n° Referencia	€
3/8" BSP	3/8"	A111306	6,36
1/2" BSP	1/2"	A111308	14,25

Empalme liso soldable rosca BSP (60°)

Welding union BSP male (60°)

Embout mâle lisse à souder gaz cyl BSP (60°)

Mezzo nipples tondo a saldare BSP

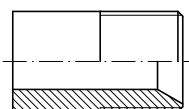

THREAD ROSCA	Part n° Referencia	€
1/8" BSP	A129002	1,36
1/4" BSP	A129004	0,79
3/8" BSP	A129006	1,00
1/2" BSP	A129008	1,22
3/4" BSP	A129012	2,22
1" BSP	A129016	5,16
1"1/4 BSP	A129020	15,41
1"1/2 BSP	A129024	16,87
2" BSP	A129032	16,71

Racor macho BSP (60°) soldable interior

Welding adaptor BSP male (60°) (internal welding)

Mamelon BSP hexagone à souder intérieur sw (60°)

Raccordo maschio BSP a saldare di tasca

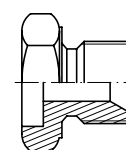

THREAD ROSCA	Part n° Referencia	€
1/8" BSP	A103102	1,56
1/4" BSP	A103104	1,00
3/8" BSP	A103106	1,21
1/2" BSP	A103108	2,33
3/4" BSP	A103112	3,59
1" BSP	A103116	6,16
1"1/4 BSP	A103120	14,51
1"1/2 BSP	A103124	19,06
2" BSP	A103132	24,39

Racor macho BSP (60°) soldable exterior

Welding adaptor BSP male (60°) (external welding)

Mamelon BSP hexagone à souder extérieur bw (60°)

Raccordo maschio BSP a saldare

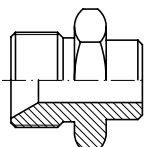

THREAD ROSCA	Part n° Referencia	€
1/8" BSP	A103002	1,68
1/4" BSP	A103004	1,04
3/8" BSP	A103006	1,40
1/2" BSP	A103008	1,79
3/4" BSP	A103012	2,99
1" BSP	A103016	4,45
1"1/4 BSP	A103020	10,47
1"1/2 BSP	A103024	13,40
2" BSP	A103032	20,42

Esférico BSP soldable exterior

BSP Banjo external welding

Banjo passage gaz à souder extérieur (bw)

Raccordo a occhio BSP a saldare

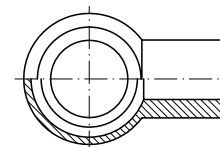

THREAD ROSCA	Ø	Part n° Referencia	€
1/8" BSP	1/8"	A114102	1,23
1/4" BSP	1/4"	A114104	1,90
3/8" BSP	3/8"	A114106	2,94
1/2" BSP	1/2"	A114108	4,90
3/4" BSP	3/4"	A114112	11,26
1" BSP	1"	A114116	33,39

Soldables para cilindros

Welding nipples for cylinders

Raccords à souder pour verins

Borchia a saldare femmina-femmina

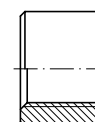

THREAD ROSCA	Part n° Referencia	€
1/4" BSP	A13110400000	0,76
3/8" BSP	A13110600000	1,07
1/2" BSP	A13110800000	1,23
3/4" BSP	A13111200000	3,03

Adaptadores BSP , BSPT y Métricos

Metric, BSP and BSPT Adaptors
Adaptateurs BSP, BSPT et Métrique
Adattatori BSP, BSPT e Metrico

Codo 90° macho-hembra giratoria BSP (60°)

90° Elbow BSP swivel female-male

Adapteur coude 90° mâle BSP x femelle tournante BSP (60°)

Curva 90° maschio-femmina girevole BSP 60°

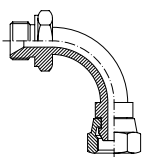

THREAD ROSCA		Part nº Referencia	€
1/4" BSP	1/4" BSP	A119404	3,38
3/8" BSP	3/8" BSP	A119406	4,46
1/2" BSP	1/2" BSP	A119408	6,31
3/4" BSP	3/4" BSP	A119412	8,60
1" BSP	1" BSP	A119416	13,37
1" 1/4 BSP	1" 1/4 BSP	A119420	21,70
1" 1/2 BSP	1" 1/2 BSP	A119424	45,24
2" BSP	2" BSP	A119432	66,07

Codo 45° macho-hembra giratoria BSP (60°)

45° Elbow BSP swivel female-male

Adapteur coude 45° mâle BSP x femelle tournante BSP (60°)

Curva 45° maschio-femmina girevole BSP 60°

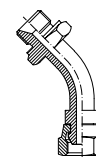

THREAD ROSCA		Part nº Referencia	€
1/4" BSP	1/4" BSP	A119504	3,30
3/8" BSP	3/8" BSP	A119506	3,86
1/2" BSP	1/2" BSP	A119508	4,02
3/4" BSP	3/4" BSP	A119512	8,28
1" BSP	1" BSP	A119516	12,78
1" 1/4 BSP	1" 1/4 BSP	A119520	21,70
1" 1/2 BSP	1" 1/2 BSP	A119524	45,24
2" BSP	2" BSP	A119532	65,89

Codo 90° hembra giratoria-hembra giratoria BSP (60°)

90° Elbow BSP swivel female-BSP swivel female

Adapteur coude 90° femelle tournante BSP x femelle tournante BSP (60°)

Curva 90° femmina-femmina girevole BSP 60°

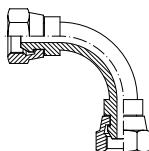

THREAD ROSCA		Part nº Referencia	€
1/4" BSP	1/4" BSP	A119604	3,49
3/8" BSP	3/8" BSP	A119606	3,85
1/2" BSP	1/2" BSP	A119608	5,22
3/4" BSP	3/4" BSP	A119612	9,18
1" BSP	1" BSP	A119616	14,05
1" 1/4 BSP	1" 1/4 BSP	A119620	24,11
1" 1/2 BSP	1" 1/2 BSP	A119624	52,95
2" BSP	2" BSP	A119632	76,33

Adaptadores BSP , BSPT y Métricos

Metric, BSP and BSPT Adaptors
Adaptateurs BSP, BSPT et Métrique
Adattatori BSP, BSPT e Metrico

Codo 90° macho-macho BSP (60°) forja

90° Elbow BSP male (60°)-BSP male (60°) forge

Adapteur coude 90° mâle BSP x mâle BSP (60°) forge

Adattatore a 90° maschio-maschio BSP (60°) forgiato

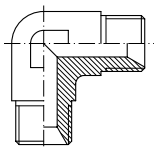

THREAD ROSCA		Part nº Referencia	€
1/8" BSP	1/8" BSP	S119002	2,84
1/4" BSP	1/4" BSP	S119004	2,51
3/8" BSP	3/8" BSP	S119006	3,28
1/2" BSP	1/2" BSP	S119008	4,14
3/4" BSP	3/4" BSP	S119012	6,59
1" BSP	1" BSP	S119016	13,47
1"1/4 BSP	1"1/4 BSP	S119020	33,45
1" 1/2 BSP	1" 1/2 BSP	S119024	40,06
2" BSP	2" BSP	S119032	101,69

Codo 90° macho BSP (60°) -macho BSPT forja

90° Elbow BSP male (60°)-BSPT male forge

Adapteur coude 90° mâle BSP x mâle gaz conique (BSPT) (60°) forge

Adattatore a 90° maschio BSP (60°) - maschio BSPT forgiato

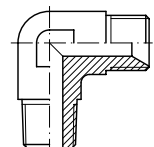

THREAD ROSCA		Part nº Referencia	€
1/8" BSP	1/8" BSPT	S119202	2,08
1/4" BSP	1/4" BSPT	S119204	2,47
3/8" BSP	3/8" BSPT	S119206	3,55
1/2" BSP	1/2" BSPT	S119208	4,48
3/4" BSP	3/4" BSPT	S119212	7,02
1" BSP	1" BSPT	S119216	15,37
1" 1/4 BSP	1" 1/4 BSPT	S119220	43,06
1" 1/2 BSP	1" 1/2 BSPT	S119224	59,08
2" BSP	2" BSPT	S119232	130,18

Codo 90° macho-macho BSPT forja

90° Elbow BSPT male-BSPT male forge

Adapteur coude 90° mâle gaz conique (BSPT) x mâle gaz conique (BSPT) forge

Adattatore a 90° maschio-maschio BSPT forgiato

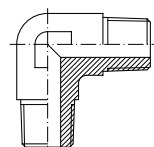

THREAD ROSCA		Part nº Referencia	€
1/4" BSPT	1/4" BSPT	S119504	5,29
3/8" BSPT	3/8" BSPT	S119506	5,71
1/2" BSPT	1/2" BSPT	S119508	6,75
3/4" BSPT	3/4" BSPT	S119512	8,94
1" BSPT	1" BSPT	S119516	18,15

Codo 90° Macho BSP (60°) - Macho NPT (60°)

90° Elbow BSP adaptor male (60°) - NPT male (60°)

Adapteur coude 90° mâle BSP (60°) x mâle NPT (60°)

Adattatore a 90° maschio BSP (60°) - maschio NPT (60°)

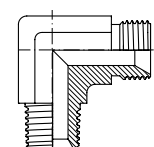

THREAD ROSCA		Part nº Referencia	€
1/4" BSP	1/4" NPT	S11880404	4,15
3/8" BSP	3/8" NPT	S11880606	6,10
1/2" BSP	1/2" NPT	S11880808	8,05
3/4" BSP	3/4" NPT	S11881212	11,19
1" BSP	1" NPT	S11881616	19,41

Codo 90° macho-macho Métrico (60°) forja

90° Elbow Metric adaptor male-male (60°) forge

Adapteur coude 90° mâle Métrique x mâle Métrique (60°) forge

Adattatore a 90° maschio-maschio Metrico

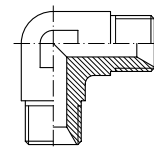

THREAD ROSCA		Part nº Referencia	€
M12x1.5	M12x1.5	S86012	6,20
M16x1.5	M16x1.5	S86016	7,65
M22x1.5	M22x1.5	S86022	15,40

Codo 90° macho BSPT-hembra fija BSP forja

90° Elbow BSPT male-BSP fixed female forge

Adapteur coude 90° mâle gaz conique (BSPT) x femelle gaz conique (BSP) forge

Adattatore a 90° maschio BSPT - femmina fissa BSP (60°) forgiato

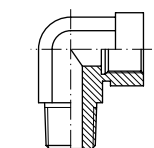

THREAD ROSCA		Part nº Referencia	€
M 1/8" BSPT	F 1/8" BSP	S119402	3,44
M 1/4" BSPT	F 1/4" BSP	S119404	4,83
M 3/8" BSPT	F 3/8" BSP	S119406	4,73
M 1/2" BSPT	F 1/2" BSP	S119408	6,06
M 3/4" BSPT	F 3/4" BSP	S119412	11,04
M 1" BSPT	F 1" BSP	S119416	18,27
M 1" 1/4 BSPT	F 1" 1/4 BSP	S119420	54,07
M 1" 1/2 BSPT	F 1" 1/2 BSP	S119424	85,26
M 2" BSPT	F 2" BSP	S119432	143,49

Codo 90° macho-hembra giratoria BSP (60°) forja

90° Elbow BSP male-BSP swivel female forge

Adapteur coude 90° mâle BSP x femelle tournante BSP (60°) forge

Adattatore a 90° maschio-femmina girevole BSP (60°) forgiato

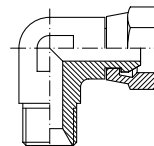

THREAD ROSCA		Part nº Referencia	€
1/8" BSP	1/8" BSP	S119302	3,73
1/4" BSP	1/4" BSP	S119304	3,71
3/8" BSP	3/8" BSP	S119306	5,25
1/2" BSP	1/2" BSP	S119308	6,19
3/4" BSP	3/4" BSP	S119312	10,19
1" BSP	1" BSP	S119316	15,19
1"1/4 BSP	1"1/4 BSP	S119320	25,44
1"1/2 BSP	1"1/2 BSP	S119324	52,41
2" BSP	2" BSP	S119332	123,90

Codo 90° macho BSPT-hembra giratoria BSP (60°) forja

90° Elbow BSPT male-BSP swivel female (60°) forge

Adapteur coude 90° mâle gaz conique (BSPT) x femelle tournante BSP (60°) forge

Adattatore a 90° maschio BSPT - femmina girevole BSP 60° forgiato

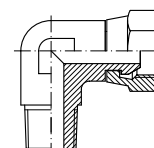

THREAD ROSCA		Part nº Referencia	€
M 1/4" BSPT	F 1/4" BSP	S119904	7,57
M 3/8" BSPT	F 3/8" BSP	S119906	9,52
M 1/2" BSPT	F 1/2" BSP	S119908	12,40
M 3/4" BSPT	F 3/4" BSP	S119912	18,61
M 1" BSPT	F 1" BSP	S119916	30,18

Adaptadores BSP , BSPT y Métricos

Metric, BSP and BSPT Adaptors
Adaptateurs BSP, BSPT et Métrique
Adattatori BSP, BSPT e Metrico

Codo 90° hembra giratoria-hembra giratoria BSP (60°) forja

90° Elbow BSP swivel female-BSP swivel female forge

Adapteur coude 90° femelle tournante BSP x femelle tournante BSP (60°) forge

Adattatore a 90° femmina girevole BSP (60°)-femmina girevole BSP (60°) forgiato

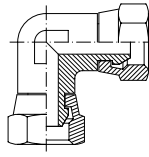

THREAD ROSCA		Part nº Referencia	€
1/8" BSP	1/8" BSP	S118302	7,38
1/4" BSP	1/4" BSP	S118304	5,00
3/8" BSP	3/8" BSP	S118306	8,61
1/2" BSP	1/2" BSP	S118308	9,85
3/4" BSP	3/4" BSP	S118312	12,79
1" BSP	1" BSP	S118316	20,47
1"1/4 BSP	1"1/4 BSP	S118320	43,39
1"1/2 BSP	1"1/2 BSP	S118324	53,11

Codo 90° orientable macho-hembra giratoria BSP (60°) forja

90° Elbow male adjustable BSP-swivel female BSP forge

Adapteur coude 90° orientable mâle-femelle tournante (60°)

Adattatore a 90° orientabile maschio-femmina girevole BSP forgiato

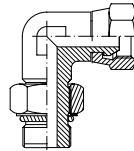

THREAD ROSCA		Part nº Referencia	€
1/4" BSP	1/4" BSP	S119104	9,96
3/8" BSP	3/8" BSP	S119106	13,37
1/2" BSP	1/2" BSP	S119108	13,90
3/4" BSP	3/4" BSP	S119112	19,37
1" BSP	1" BSP	S119116	28,63

Codo 45° macho-hembra giratoria forja BSP 60° forja

45° Elbow BSP male-BSP swivel female forge

Adapteur coude 45° mâle-femelle tournante BSP forge

Adattatore a 45° maschio-femmina girevole BSP forgiato

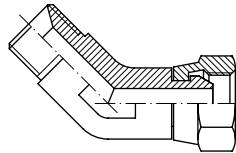

THREAD ROSCA		Part nº Referencia	€
1/8" BSP	1/8" BSP	S118502	4,10
1/4" BSP	1/4" BSP	S118504	3,51
3/8" BSP	3/8" BSP	S118506	4,38
1/2" BSP	1/2" BSP	S118508	5,93
3/4" BSP	3/4" BSP	S118512	8,41
1" BSP	1" BSP	S118516	14,47
1"1/4 BSP	1"1/4 BSP	S118520	24,94

Codo 90° hembra fija-hembra fija BSP forja

90° Elbow BSP fixed female-BSP fixed female forge

Adapteur coude 90° femelle fixe gaz cyl forge

Adattatore a 90° maschio BSPT - femmina fissa BSP forgiato

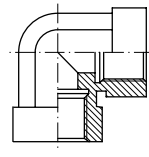

THREAD ROSCA		Part nº Referencia	€
1/8" BSP	1/8" BSP	S119602	3,73
1/4" BSP	1/4" BSP	S119604	3,88
3/8" BSP	3/8" BSP	S119606	4,68
1/2" BSP	1/2" BSP	S119608	7,77
3/4" BSP	3/4" BSP	S119612	9,36
1" BSP	1" BSP	S119616	17,11
1"1/4 BSP	1"1/4 BSP	S119620	54,66
1" 1/2 BSP	1" 1/2 BSP	S119624	89,39
2" BSP	2" BSP	S119632	136,07

Codo 90° macho BSP (60°) -macho BSP regulable forja

90° Elbow BSP male-BSP male adjustable forge

Adapteur coude 90° mâle BSP x mâle gaz cyl orientable or + bae en forge

Adattatore a 90° maschio BSP 60° - maschio BSP regolabile forgiato

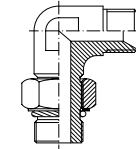

THREAD ROSCA		Part nº Referencia	€
1/8" BSP	1/8" BSP	S11970202	3,54
1/4" BSP	1/4" BSP	S11970404	4,09
3/8" BSP	1/4" BSP	S11970604	5,66
3/8" BSP	3/8" BSP	S11970606	5,24
1/2" BSP	3/8" BSP	S11970806	6,11
1/2" BSP	1/2" BSP	S11970808	6,92
3/4" BSP	1/2" BSP	S11971208	11,80
3/4" BSP	3/4" BSP	S11971212	11,28
1" BSP	3/4" BSP	S11971612	20,09
1" BSP	1" BSP	S11971616	15,92
1"1/4 BSP	1"1/4 BSP	S11972020	31,25
1" 1/2 BSP	1" 1/2 BSP	S11972424	48,07
2" BSP	2" BSP	S11973232	132,50

Codo 90° Pasatabique Macho BSP (60°) - Macho BSP (60°)

90° Elbow bulkhead BSP adaptor male-male (60°)

Adapteur coude 90° passe cloison mâle BSP (60°) x mâle BSP (60°)

Adattatore a 90° pasaparete maschio-maschio BSP (60°)

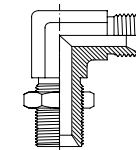

THREAD ROSCA		Part nº Referencia	€
1/4" BSP	1/4" BSP	S11860404	6,61
3/8" BSP	3/8" BSP	S11860606	8,53
1/2" BSP	1/2" BSP	S11860808	11,32
3/4" BSP	3/4" BSP	S11861212	18,32
1" BSP	1" BSP	S11861616	28,48

Adaptadores BSP , BSPT y Métricos

Metric, BSP and BSPT Adaptors
Adaptateurs BSP, BSPT et Métrique
Adattatori BSP, BSPT e Metrico

Codo 45° macho BSP (60°) - macho BSP regulable forja

45° Elbow BSP male-BSP male adjustable forge

Adapteur coude 45° mâle BSP x mâle gaz cyl orientable or + bae en forge

Adattatore a 45° maschio BSP 60° - maschio BSP regolabile forgiato

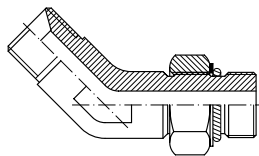

THREAD ROSCA		Part nº Referencia	€
M 1/8" BSP	MR 1/8" BSP	S11980202	3,95
M 1/4" BSP	MR 1/4" BSP	S11980404	4,22
M 3/8" BSP	MR 3/8" BSP	S11980606	7,67
M 1/2" BSP	MR 1/2" BSP	S11980808	8,60
M 3/4" BSP	MR 3/4" BSP	S11981212	9,82
M 1" BSP	MR 1" BSP	S11981616	17,77
M 1 1/4" BSP	MR 1 1/4" BSP	S11982020	36,61

Codo 45° Macho BSP (60°) - Macho NPT (60°)

45° Elbow BSP adaptor male (60°) - NPT male (60°)

Adapteur coude 45° mâle BSP (60°) x mâle NPT (60°)

Adattatore a 45° maschio BSP (60°) - maschio NPT (60°)

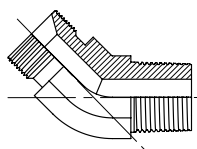

THREAD ROSCA		Part nº Referencia	€
1/4" BSP	1/4" NPT	S11810404	4,15
3/8" BSP	3/8" NPT	S11810606	6,10
1/2" BSP	1/2" NPT	S11810808	8,05
3/4" BSP	3/4" NPT	S11811212	11,70
1" BSP	1" NPT	S11811616	20,09

Codo 45° Macho BSP (60°) - Macho BSPT

45° Elbow BSP adaptor male (60°) - BSPT male

Adapteur coude 45° mâle BSP (60°) x mâle BSPT

Adattatore a 45° maschio BSP (60°) - maschio BSPT

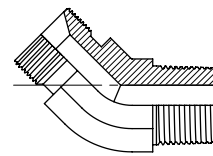

THREAD ROSCA		Part nº Referencia	€
1/4" BSP	1/4" BSPT	S11870404	5,00
3/8" BSP	3/8" BSPT	S11870606	6,70
1/2" BSP	1/2" BSPT	S11870808	8,98
3/4" BSP	3/4" BSPT	S11871212	10,47
1" BSP	1" BSPT	S11871616	20,00

Codo 45° Regulable Macho BSP - H.G. BSP (60°)

45° Adjustable BSP elbow adaptor male (60°) - BSP female (60°)

Adapteur coude 45° réglable mâle BSP (60°) x femelle tournante BSP (60°)

Adattatore a 45° orientabile maschio BSP (60°) - femmina girevole BSP (60°)

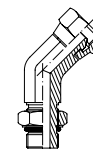

THREAD ROSCA		Part nº Referencia	€
1/4" BSP	1/4" BSP	S11820404	7,54
3/8" BSP	3/8" BSP	S11820606	12,04
1/2" BSP	1/2" BSP	S11820808	15,17
3/4" BSP	3/4" BSP	S11821212	19,92
1" BSP	1" BSP	S11821616	32,80

Adaptadores BSP , BSPT y Métricos

Metric, BSP and BSPT Adaptors
Adaptateurs BSP, BSPT et Métrique
Adattatori BSP, BSPT e Metrico

Te macho-macho-macho BSP forja

Tee BSP Male (60°) forge

Adaptateur Té mâle BSP-mâle BSP-mâle BSP (60°) forge

Adattatore a T maschio BSP (60°) forgiato

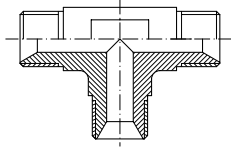

THREAD ROSCA			Part n° Referencia	€
1/8" BSP	1/8" BSP	1/8" BSP	S122002	3,46
1/4" BSP	1/4" BSP	1/4" BSP	S122004	3,58
3/8" BSP	3/8" BSP	3/8" BSP	S122006	4,34
1/2" BSP	1/2" BSP	1/2" BSP	S122008	5,94
3/4" BSP	3/4" BSP	3/4" BSP	S122012	8,44
1" BSP	1" BSP	1" BSP	S122016	15,48
1"1/4 BSP	1"1/4 BSP	1"1/4 BSP	S122020	43,98
1"1/2 BSP	1"1/2 BSP	1"1/2 BSP	S122024	75,86
2" BSP	2" BSP	2" BSP	S122032	156,07

Te macho-macho-hembra giratoria BSP (60°) forja

Barrel tee BSP Male-male-swivel female (60°) forge

Adaptateur Té mâle BSP-mâle BSP-femelle tournante BSP (60°) forge

Adattatore a T maschio-maschio-femmine girevole BSP forgiato

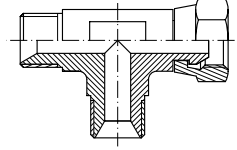

THREAD ROSCA			Part n° Referencia	€
1/8" BSP	1/8" BSP	1/8" BSP	S122302	4,01
1/4" BSP	1/4" BSP	1/4" BSP	S122304	4,64
3/8" BSP	3/8" BSP	3/8" BSP	S122306	5,93
1/2" BSP	1/2" BSP	1/2" BSP	S122308	7,72
3/4" BSP	3/4" BSP	3/4" BSP	S122312	13,04
1" BSP	1" BSP	1" BSP	S122316	19,74
1"1/4 BSP	1"1/4 BSP	1"1/4 BSP	S122320	32,69
1" 1/2 BSP	1" 1/2 BSP	1" 1/2 BSP	S122324	82,65
2" BSP	2" BSP	2" BSP	S122332	185,69

Te macho-hembra giratoria-macho BSP (60°) forja

Brunch tee BSP Male-swivel female-male (60°) forge

Adaptateur Té mâle BSP-femelle tournante BSP-mâle BSP (60°) forge

Adattatore a T maschio-femmina girevole-maschio BSP forgiato

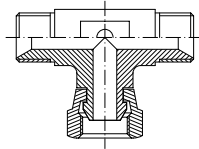

THREAD ROSCA			Part n° Referencia	€
1/8" BSP	1/8" BSP	1/8" BSP	S122402	4,34
1/4" BSP	1/4" BSP	1/4" BSP	S122404	4,12
3/8" BSP	3/8" BSP	3/8" BSP	S122406	5,54
1/2" BSP	1/2" BSP	1/2" BSP	S122408	7,72
3/4" BSP	3/4" BSP	3/4" BSP	S122412	12,23
1" BSP	1" BSP	1" BSP	S122416	19,74
1"1/4 BSP	1"1/4 BSP	1"1/4 BSP	S122420	32,69
1" 1/2 BSP	1" 1/2 BSP	1" 1/2 BSP	S122424	90,35
2" BSP	2" BSP	2" BSP	S122432	202,99

Te macho-macho-macho Métrica (60°)

Tee Metric male (60°)

Adaptateur Té égal mâle-mâle-mâle Métrique (60°)

Adattatore a T maschio-maschio-maschio Metrico

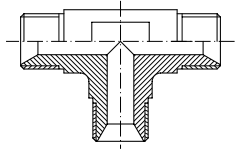

THREAD ROSCA			Part n° Referencia	€
M16x1.5	M16x1.5	M16x1.5	S86516	10,05
M18x1.5	M18x1.5	M18x1.5	S86518	10,85
M20x1.5	M20x1.5	M20x1.5	S86520	13,13
M22x1.5	M22x1.5	M22x1.5	S86522	13,13
M26x1.5	M26x1.5	M26x1.5	S86526	21,44
M30x1.5	M30x1.5	M30x1.5	S86530	28,44

Te hembras giratorias BSP (60°) forja

Tee BSP Swivel female (60°) forge

Adaptateur Té femelle tournante BSP (60°) forge

Adattatore a T femmina girevole BSP forgiato

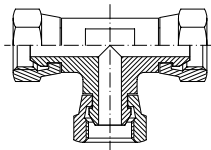

THREAD ROSCA			Part n° Referencia	€
1/8" BSP	1/8" BSP	1/8" BSP	S122502	8,99
1/4" BSP	1/4" BSP	1/4" BSP	S122504	6,91
3/8" BSP	3/8" BSP	3/8" BSP	S122506	8,82
1/2" BSP	1/2" BSP	1/2" BSP	S122508	11,33
3/4" BSP	3/4" BSP	3/4" BSP	S122512	20,14
1" BSP	1" BSP	1" BSP	S122516	32,46
1" 1/4 BSP	1" 1/4 BSP	1" 1/4 BSP	S122520	67,84

Te hembras fijas BSP forja

Tee BSP fixed female forge

Adaptateur Té femelle fixe gaz (BSP) forge

Adattatore a T femmina fissa BSP

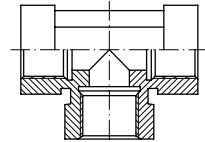

THREAD ROSCA			Part n° Referencia	€
1/8" BSP	1/8" BSP	1/8" BSP	S122602	4,37
1/4" BSP	1/4" BSP	1/4" BSP	S122604	4,76
3/8" BSP	3/8" BSP	3/8" BSP	S122606	6,75
1/2" BSP	1/2" BSP	1/2" BSP	S122608	9,20
3/4" BSP	3/4" BSP	3/4" BSP	S122612	14,30
1" BSP	1" BSP	1" BSP	S122616	26,01
1"1/4 BSP	1"1/4 BSP	1"1/4 BSP	S122620	90,56
1" 1/2 BSP	1" 1/2 BSP	1" 1/2 BSP	S122624	130,10
2" BSP	2" BSP	2" BSP	S122632	236,09

Adaptadores BSP , BSPT y Métricos

Metric, BSP and BSPT Adaptors
Adaptateurs BSP, BSPT et Métrique
Adattatori BSP, BSPT e Metrico

Te macho-macho-macho regulable BSP forja

Barrel tee BSP male-male-male adjustable forge

Adaptateur Té égal mâle (60°)-mâle (60°)-mâle orientable BSP forge

Adattatore a T maschio-maschio-maschio orientabile BSP

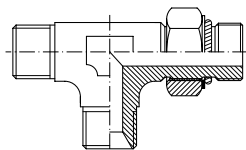

THREAD ROSCA			Part nº Referencia	€
1/4" BSP	1/4" BSP	1/4" BSP	S12290404	5,95
3/8" BSP	3/8" BSP	3/8" BSP	S12290606	9,23
1/2" BSP	3/8" BSP	1/2" BSP	S12290806	15,76
1/2" BSP	1/2" BSP	1/2" BSP	S12290808	15,43
3/4" BSP	1/2" BSP	3/4" BSP	S12291208	24,66
3/4" BSP	3/4" BSP	3/4" BSP	S12291212	36,45
1" BSP	3/4" BSP	1" BSP	S12291612	41,36
1" BSP	1" BSP	1" BSP	S12291616	53,58
1"1/4 BSP	1"1/4 BSP	1"1/4 BSP	S12292020	54,58

Te macho-macho regulable-macho BSP forja

Brunch tee BSP male-male adjustable-male forge

Adaptateur Té égal mâle (60°)-mâle orientable-mâle (60°) BSP forge

Adattatore a T maschio-maschio orientabile-maschio forgiato

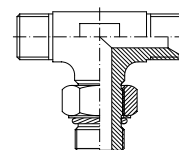

THREAD ROSCA			Part nº Referencia	€
1/4" BSP	1/4" BSP	1/4" BSP	S12280404	5,95
3/8" BSP	1/4" BSP	3/8" BSP	S12280604	12,04
3/8" BSP	3/8" BSP	3/8" BSP	S12280606	12,72
1/2" BSP	3/8" BSP	1/2" BSP	S12280806	15,76
1/2" BSP	1/2" BSP	1/2" BSP	S12280808	15,69
3/4" BSP	1/2" BSP	3/4" BSP	S12281208	24,66
3/4" BSP	3/4" BSP	3/4" BSP	S12281212	25,26
1" BSP	3/4" BSP	1" BSP	S12281612	48,14
1" BSP	1" BSP	1" BSP	S12281616	51,33
1"1/4 BSP	1" BSP	1"1/4 BSP	S12282016	54,24
1"1/4 BSP	1"1/4 BSP	1"1/4 BSP	S12282020	60,35

Cruz hembra fija BSP

Cross fixed female BSP

Cross BSP femelle fixe

BSP femmina fisso a croce

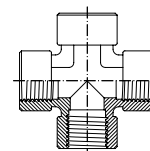

THREAD ROSCA	Part nº Referencia	€
1/8" BSP	S122702	8,29
1/4" BSP	S122704	9,32
3/8" BSP	S122706	10,36
1/2" BSP	S122708	12,43
3/4" BSP	S122712	14,50
1" BSP	S122716	20,72

Adaptadores BSP , BSPT y Métricos

Metric, BSP and BSPT Adaptors
Adaptateurs BSP, BSPT et Métrique
Adattatori BSP, BSPT e Metrico

Codo cuadrado 90° reductor macho-macho BSP (60°)

90° reducer elbow male-male BSP (60°) (square)

Adapteur carré coude 90° reducteur mâle BSP - mâle BSP (60°) en bloque

Adattatore a 90° maschio-maschio quadrato BSP (60°)

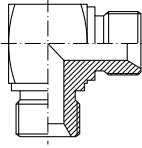

THREAD ROSCA		Part n° Referencia	€
1/8" BSP	1/4" BSP	A11920204	5,75
1/4" BSP	3/8" BSP	A11920406	7,08
3/8" BSP	1/2" BSP	A11920608	10,40
1/2" BSP	3/4" BSP	A11920812	14,22
3/4" BSP	1" BSP	A11921216	33,31

Codo cuadrado 90° macho BSP

90° Elbow BSP male (square)

Adapteur carré Coude 90° mâle BSP

Adattatore a 90° maschio-maschio quadrato BSP (60°)

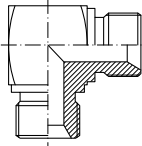

THREAD ROSCA		Part n° Referencia	€
1/4" BSP	1/4" BSP	A21900400	3,79
3/8" BSP	3/8" BSP	A21900600	4,19
1/2" BSP	1/2" BSP	A21900800	6,05
3/4" BSP	3/4" BSP	A21901200	8,77
1" BSP	1" BSP	A21901600	16,95

Codo cuadrado 90° macho-hembra giratoria

90° Elbow BSP male-BSP swivel female (square)

Adapteur carré Coude 90° mâle BSP - femelle BSP

Adattatore a 90° maschio-femmina girevole quadrato BSP (60°)

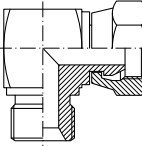

THREAD ROSCA		Part n° Referencia	€
1/4" BSP	1/4" BSP	A21930400	4,67
3/8" BSP	3/8" BSP	A21930600	5,18
1/2" BSP	1/2" BSP	A21930800	7,49
3/4" BSP	3/4" BSP	A21931200	10,37
1" BSP	1" BSP	A21931600	30,03

Te cuadrado macho-macho-macho

Tee BSP male (square)

Adapteur carré Té mâle BSP-mâle BSP-mâle BSP

Adattatore a T maschio quadrato BSP 60°

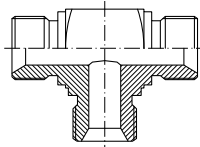

THREAD ROSCA			Part n° Referencia	€
1/4" BSP	1/4" BSP	1/4" BSP	A22200400	4,85
3/8" BSP	3/8" BSP	3/8" BSP	A22200600	5,66
1/2" BSP	1/2" BSP	1/2" BSP	A22200800	8,44
3/4" BSP	3/4" BSP	3/4" BSP	A22201200	12,76
1" BSP	1" BSP	1" BSP	A22201600	24,29

Te cuadrado macho-hembra giratoria-macho

Branch tee BSP male-swivel female-male (square)

Adapteur carré Té mâle BSP-femelle tournante BSP-mâle BSP

Adattatore a T maschio-femmina girevole-maschio quadrato BSP (60°)

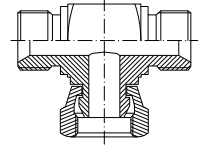

THREAD ROSCA			Part n° Referencia	€
1/4" BSP	1/4" BSP	1/4" BSP	A22240400	5,05
3/8" BSP	3/8" BSP	3/8" BSP	A22240600	6,52
1/2" BSP	1/2" BSP	1/2" BSP	A22240800	9,17
3/4" BSP	3/4" BSP	3/4" BSP	A22241200	12,96
1" BSP	1" BSP	1" BSP	A22241600	24,80

Te cuadrado macho-macho-hembra giratoria

Barrel tee BSP male-male-swivel female (square)

Adapteur carré Té mâle BSP-mâle BSP-femelle tournante BSP

Adattatore a T maschio-maschio-femmina girevole quadrato BSP

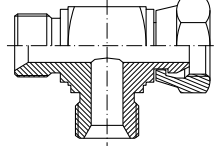

THREAD ROSCA			Part n° Referencia	€
1/4" BSP	1/4" BSP	1/4" BSP	A22220400	5,25
3/8" BSP	3/8" BSP	3/8" BSP	A22220600	6,70
1/2" BSP	1/2" BSP	1/2" BSP	A22220800	8,71
3/4" BSP	3/4" BSP	3/4" BSP	A22221200	18,42
1" BSP	1" BSP	1" BSP	A22221600	23,58

Cruz cuadrada macho BSP

Cross BSP male (square)

Adapteur carré Croix égale mâle BSP

Croce maschio BSP 60°

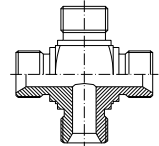

THREAD ROSCA		Part n° Referencia	€
1/4" BSP		A22230400	7,24
3/8" BSP		A22230600	6,78
1/2" BSP		A22230800	12,76
3/4" BSP		A22231200	22,39
1" BSP		A22231600	22,39

Adaptadores BSP , BSPT y Métricos

Metric, BSP and BSPT Adaptors
Adaptateurs BSP, BSPT et Métrique
Adattatori BSP, BSPT e Metrico

Juntas Metal Buna BSP Autocentrantes

BSP Bonded Seal

Bague BS BSPz

Rondelle Bonded BSP

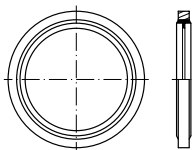

THREAD ROSCA	UNITS PER BAG CANTIDAD / BOLSA	Part nº Referencia	€
1/8" BSP	100	T21002	0,19
1/4" BSP	100	T21004	0,20
3/8" BSP	100	T21006	0,25
1/2" BSP	100	T21008	0,28
5/8" BSP	100	T21010	0,59
3/4" BSP	100	T21012	0,39
1" BSP	50	T21016	0,67
1" 1/4 BSP	25	T21020	1,01
1" 1/2 BSP	25	T21024	1,23
2" BSP	25	T21032	1,85
2" 1/2 BSP	25	T21040	20,79

Se venden en bolsas, precios por unidad. / Sold in bags, prices per unit / Vendu dans des sacs, prix par unité / Venduti in sacchetti, prezzo per unità

Juntas Metal Buna Métricas Autocentrantes

Metric Bonded Seal

Bague BS Métrique

Rondelle Bonded Metriche

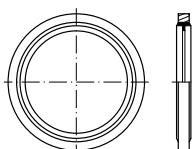

THREAD ROSCA	UNITS PER BAG CANTIDAD / BOLSA	Part nº Referencia	€
M6X1	100	T32006	0,28
M8x1	100	T32008	0,24
M10x1	100	T32010	0,24
M12x1.5	100	T32012	0,26
M14x1.5	100	T32014	0,27
M16x1.5	100	T32016	0,29
M18x1.5	100	T32018	0,33
M20x1.5	100	T32020	0,34
M22x1.5	100	T32022	0,37
M24x1.5	100	T32024	0,43
M26x1.5	100	T32026	0,62
M27X1,5	100	T32027	1,12
M30x2	50	T32030	0,68
M36x2	25	T32036	1,28
M42x2	25	T32042	2,64
M48X2	25	T32048	3,20

Se venden en bolsas, precios por unidad. / Sold in bags, prices per unit / Vendu dans des sacs, prix par unité / Venduti in sacchetti, prezzo per unità

Arandelas Aluminio BSP

BSP Aluminium Collar Plate

Rondelle BSP Aluminium

Rondella in Alluminio BSP

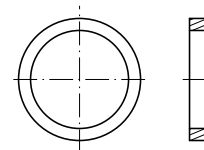

THREAD ROSCA	Ø OUTER Ø EXT.	Ø INNER Ø INT.	Part nº Referencia	€
1/8"	14	10	A133202	0,10
1/4"	19	13	A133204	0,13
3/8"	22	17	A133206	0,17
1/2"	27	21	A133208	0,27
3/4"	33	27	A133212	0,35
1"	41	33	A133216	0,51
1" 1/4	50	42	A133220	1,45
1" 1/2	60	48	A133224	0,93

Arandelas plana Cobre recocido BSP

BSP Annealed Copper flat Plate

Rondelle plane BSP Cuivre recuit

Rondella in Rame BSP

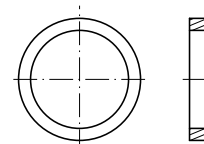

THREAD ROSCA	Ø OUTER Ø EXT.	Ø INNER Ø INT.	Part nº Referencia	€
1/8"	14	10	A133002	0,22
1/4"	19	13	A133004	0,34
3/8"	22	17	A133006	0,34
1/2"	27	21	A133008	0,55
3/4"	33	27	A133012	0,98
1"	41	33	A133016	1,09
1" 1/4	50	42	A133020	1,52
1" 1/2	56	48	A133024	2,89
2"	72	60	A133032	4,79

Arandelas plana Acero BSP

BSP Steel flat Plate

Bague plate Acier BSP

Rondelle in Acciaio BSP

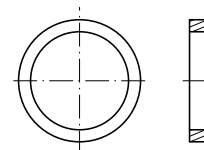

THREAD ROSCA	Ø OUTER Ø EXT.	Ø INNER Ø INT.	Part nº Referencia	€
1/8"	15	12.2	A13330200000	1,16
1/4"	19.5	16.15	A13330400000	1,14
3/8"	23.5	19.5	A13330600000	1,07
1/2"	28.5	23.3	A13330800000	1,17
3/4"	34.5	28.6	A13331200000	1,23
1"	43.5	36.6	A13331600000	1,35
1" 1/4	52.5	44.9	A13332000000	1,50

Adaptadores NPT

NPT Adaptors
Adaptateurs NPT
Adattatori NPT

Adaptor macho - macho NPT

Adaptor male NPT - male NPT

Adaptateur mâle NPT - mâle NPT

Nipples di congiunzione NPT

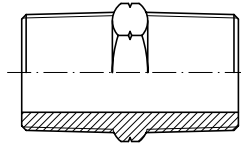

THREAD ROSCA		Part n° Referencia	€
1/8" NPT	1/8" NPT	A10150202	1,06
1/4" NPT	1/4" NPT	A10150404	1,58
3/8" NPT	3/8" NPT	A10150606	2,00
1/2" NPT	1/2" NPT	A10150808	2,16
3/4" NPT	3/4" NPT	A10151212	4,12
1" NPT	1" NPT	A10151616	6,18
1" 1/4 NPT	1" 1/4 NPT	A10152020	11,11
1" 1/2 NPT	1" 1/2 NPT	A10152424	16,03
2" NPT	2" NPT	A10153232	35,74

Reductor macho - macho NPT

Reducer male NPT - male NPT

Réducteur mâle NPT - mâle NPT

Nipples di riduzione maschio - maschio NPT

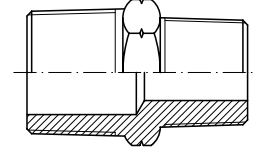

THREAD ROSCA		Part n° Referencia	€
1/4" NPT	1/8" NPT	A10150402	1,07
3/8" NPT	1/8" NPT	A10150602	1,17
3/8" NPT	1/4" NPT	A10150604	1,80
1/2" NPT	1/4" NPT	A10150804	2,23
1/2" NPT	3/8" NPT	A10150806	2,10
3/4" NPT	1/4" NPT	A10151204	3,53
3/4" NPT	3/8" NPT	A10151206	3,53
3/4" NPT	1/2" NPT	A10151208	3,49
1" NPT	1/2" NPT	A10151608	6,67
1" NPT	3/4" NPT	A10151612	6,76
1" 1/4 NPT	1" NPT	A10152016	12,03
1" 1/2 NPT	1" 1/4 NPT	A10152420	16,03
2" NPT	1" 1/2 NPT	A10153224	35,74

Adaptador Macho NPT (60°) - H.G. NPSM (60°)

Adaptor male NPT (60°) - swivel female NPSM (60°)

Adaptateur mâle NPT (60°) - femelle tournante NPSM (60°)

Nipples di congiunzione maschio NPT (60°) - femmina girevole NPSM (60°)

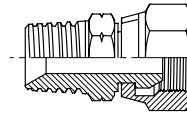

THREAD ROSCA		Part n° Referencia	€
M 1/4" NPT	F 1/4" NPSM	N11700404	3,90
M 3/8" NPT	F 3/8" NPSM	N11700606	5,00
M 1/2" NPT	F 1/2" NPSM	N11700808	6,61
M 3/4" NPT	F 3/4" NPSM	N11701212	7,57
M 1" NPT	F 1" NPSM	N11701616	15,51
M 1" 1/4 NPT	F 1" 1/4 NPSM	N11702020	23,56

Adaptador Macho NPT (60°) - Hembra Fija NPT

Adaptor male NPT (60°) - fixed female NPT

Adaptateur mâle NPT (60°) - femelle fixe NPT

Nipples di congiunzione maschio NPT (60°) - femmina fissa NPT

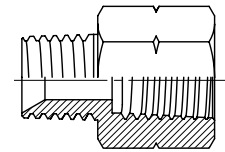

THREAD ROSCA		Part n° Referencia	€
M 1/4" NPT	F 1/4" NPT	N10600404	3,09
M 1/4" NPT	F 3/8" NPT	N10600406	3,78
M 3/8" NPT	F 1/4" NPT	N10600604	2,64
M 3/8" NPT	F 3/8" NPT	N10600606	3,90
M 3/8" NPT	F 1/2" NPT	N10600608	6,19
M 1/2" NPT	F 3/8" NPT	N10600806	4,66
M 1/2" NPT	F 1/2" NPT	N10600808	6,36
M 1/2" NPT	F 3/4" NPT	N10600812	8,73
M 3/4" NPT	F 3/4" NPT	N10601212	9,07
M 1" NPT	F 1" NPT	N10601616	14,15

Adaptadores NPT

NPT Adaptors
Adaptateurs NPT
Adattatori NPT

Adaptador Hembra Fija NPT - Hembra Fija NPT

NPT adaptor fixed female - fixed female NPT

Adaptateur femelle fixe NPT - femelle fixe NPT

Adattatore femmina fissa NPT - femmina fissa NPT

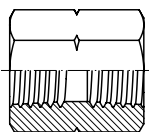

THREAD ROSCA	Part nº Referencia	€
1/4" NPT	N103100404	2,40
3/8" NPT	N103100606	3,06
1/2" NPT	N103100808	5,21
3/4" NPT	N103101212	7,41
1" NPT	N103101616	11,21

Tapón HF NPT

NPT fixed female cap

Bouchon femelle fixe NPT

Tappo femmina fissa NPT

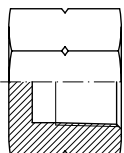

THREAD ROSCA	Part nº Referencia	€
1/8" NPT	N107202	0,80
1/4" NPT	N107204	1,00
3/8" NPT	N107206	1,54
1/2" NPT	N107208	2,19
3/4" NPT	N107212	3,18
1" NPT	N107216	5,07

Tapón Allen NPT

NPT Allen plug

Bouchon Allen NPT

Tappo conico NPT

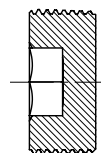

THREAD ROSCA	Part nº Referencia	€
1/4" NPT	N107104	1,36
3/8" NPT	N107106	1,94
1/2" NPT	N107108	2,58
3/4" NPT	N107112	3,48
1" NPT	N107116	5,85

Tapón macho NPT

NPT male plug

Bouchon mâle NPT

Tappo maschio NPT

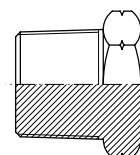

THREAD ROSCA	Part nº Referencia	€
1/4" NPT	N107004	1,04
3/8" NPT	N107006	1,23
1/2" NPT	N107008	1,88
3/4" NPT	N107012	3,62
1" NPT	N107016	5,56

Quick-release couplings

Ball valves

Diversers

Swivel fittings

Multi-way couplings

Protections

Adaptadores NPT

NPT Adaptors
Adapteurs NPT
Adattatori NPT

Codo 45 Macho NPT (60°) - Macho NPT (60°)

45° elbow male NPT 60 - male NPT 60

Coude 45° mâle NPT 60° - mâle NPT 60°

Adattatore a 45° maschio 60 - maschio NPT 60

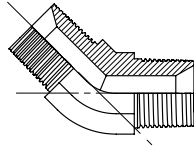

THREAD ROSCA	Part n° Referencia	€
1/4" NPT	N11980404	3,81
3/8" NPT	N11980606	5,17
1/2" NPT	N11980808	7,37
3/4" NPT	N11981212	11,27
1" NPT	N11981616	17,88

Codo 90° HF-HF NPT

90° elbow fixed female NPT - fixed female NPT

Coude 90° femelle fixe NPT - femelle fixe NPT

Adattatore a 90° femmina fissa - femmina fissa NPSM

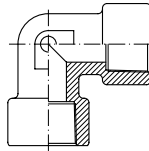

THREAD ROSCA	Part n° Referencia	€
1/8" NPT	N119602	2,53
1/4" NPT	N119604	3,92
3/8" NPT	N119606	5,09
1/2" NPT	N119608	7,98
3/4" NPT	N119612	13,26
1" NPT	N119616	19,70
1 1/4" NPT	N119620	29,17
1 1/2" NPT	N119624	53,56
2" NPT	N119632	95,35

Codo 90° M-M NPT

90° elbow male NPT - male NPT

Coude 90° mâle NPT - mâle NPT

Adattatore a 90° maschio - maschio NPT

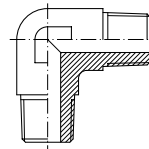

THREAD ROSCA	Part n° Referencia	€
1/8" NPT	N119002	2,47
1/4" NPT	N119004	3,08
3/8" NPT	N119006	4,02
1/2" NPT	N119008	5,71
3/4" NPT	N119012	9,04
1" NPT	N119016	14,75
1 1/4" NPT	N119020	25,24
1 1/2" NPT	N119024	35,65
2" NPT	N119032	73,86

Codo 90 Macho NPT (60°) - H.G. NPSM (60°)

90° elbow male NPT 60 - swivel female NPSM 60

Coude 90° mâle NPT 60° - femelle tournante NPSM 60°

Adattatore a 90° maschio NPT 60 - femmina girevole NPSM 60

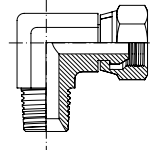

THREAD ROSCA	Part n° Referencia	€	
M 1/4" NPT	F 1/4" NPSM	N11930404	5,34
M 3/8" NPT	F 3/8" NPSM	N11930606	7,04
M 1/2" NPT	F 1/2" NPSM	N11930808	8,21
M 3/4" NPT	F 3/4" NPSM	N11931212	13,31
M 1" NPT	F 1" NPSM	N11931616	21,02
M 1 1/4" NPT	F 1 1/4" NPSM	N11932020	35,26

Codo 45 Hembra Fija NPT - Hembra Fija NPT

45° elbow fixed female NPT - fixed female NPT

Coude 45° femelle fixe NPT - femelle fixe NPT

Adattatore a 45° femmina fissa 60 - femmina fissa NPT 60

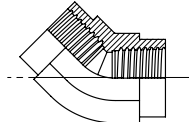

THREAD ROSCA	Part n° Referencia	€
1/4" NPT	N11960404	5,85
3/8" NPT	N11960606	7,04
1/2" NPT	N11960808	9,49
3/4" NPT	N11961212	13,99
1" NPT	N11961616	23,39

Codo 45 Macho NPT (60°) - H.G. NPSM (60°)

45° elbow male NPT 60° - swivel female NPSM 60°

Coude 45° mâle NPT 60° - swivel female NPSM 60°

Adattatore a 45° maschio NPT 60 - femmina girevole NPSM 60

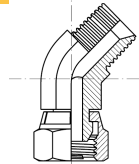

THREAD ROSCA	Part n° Referencia	€	
M 1/4" NPT	F 1/4" NPSM	N13930404	5,58
M 3/8" NPT	F 3/8" NPSM	N13930606	7,35
M 1/2" NPT	F 1/2" NPSM	N13930808	9,39
M 3/4" NPT	F 3/4" NPSM	N13931212	13,90
M 1" NPT	F 1" NPSM	N13931616	21,96
M 1 1/4" NPT	F 1 1/4" NPSM	N13932020	38,87

Adaptadores NPT

NPT Adaptors
Adapteurs NPT
Adattatori NPT

Adaptors

T M-M-M NPT

NPT male tee

Té mâle NPT

Adattatore a T maschio-maschio-maschio NPT

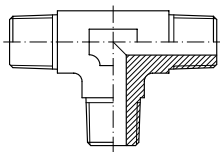

THREAD ROSCA	Part n° Referencia	€
1/8" NPT	N122002	3,80
1/4" NPT	N122004	4,01
3/8" NPT	N122006	5,06
1/2" NPT	N122008	9,89
3/4" NPT	N122012	16,36
1" NPT	N122016	22,09
1" 1/4 NPT	N122020	52,29
3/4" NPT	N122024	84,59
2" NPT	N122032	188,58

T HF-HF-HF NPT

NPT fixed female tee

Té femelle fixe NPT

Adattatore a T femmina fissa-femmina fissa-femmina fissa NPT

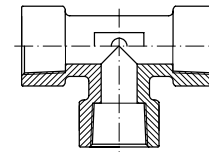

THREAD ROSCA	Part n° Referencia	€
1/8" NPT	N122602	4,44
1/4" NPT	N122604	5,16
3/8" NPT	N122606	7,59
1/2" NPT	N122608	12,93
3/4" NPT	N122612	18,08
1" NPT	N122616	28,18
1" 1/4 NPT	N122620	53,65
1" 1/2 NPT	N122624	121,03
2" NPT	N122632	200,45

Quick-release couplings

Ball valves

Diverter

Swivel fittings

Multi-way couplings

Protections

Thread data table

Tabla de roscas

Tableau de raccords

Tableau de raccords

METRICA

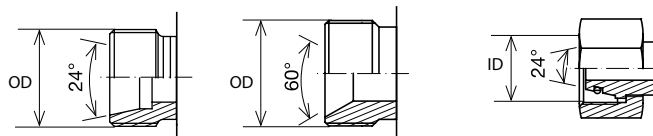

JIC

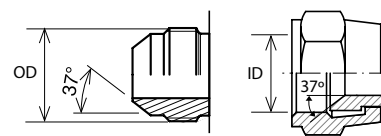

Métrica Metricale Métrique Metrica	Cono 24° 24° cone Cone 24° Cono 24°	Cono 60° 60° cone Cone 60° Cono 60°	Male thread OD	Female thread ID
12 x 1,5			12	10,5
14 x 1,5			14	12,5
16 x 1,5			16	14,5
18 x 1,5			18	16,5
20 x 1,5			20	18,5
22 x 1,5			22	20,5
24 x 1,5			24	22,5
26 x 1,5			26	24,5
30 x 1,5			30	28,5
30 x 2			30	28,00
36 x 2			36	34,00
38 x 1,5			38	36,5
42 x 2			42	40,00
45 x 1,5			45	43,5
45 x 2			45	43
52 x 1,5			52	50,5
52 x 2			52	50
65 x 2			65	63
78 x 2			78	76

SAE	Male thread OD	Female thread ID
7/16-20	11,07	10,00
1/2-20	12,70	11,60
9/16-18	14,25	13,00
5/8-18	15,85	14,70
3/4-16	19,00	17,60
7/8-14	22,17	20,50
1 1/16-12	26,95	25,00
1 1/16-14	26,95	25,30
1 5/16-12	33,30	31,30
1 5/16-14	33,30	31,60
1 5/8-12	41,42	39,20
1 5/8-14	41,22	39,50
1 7/8-12	47,57	45,60
1 7/8-14	47,57	45,90
2 1/2-12	63,45	61,50
3-12	76,20	74,30

BSP

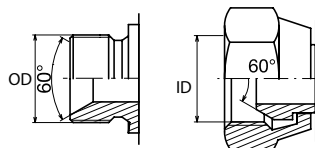

NPT-BSPT-NPSM

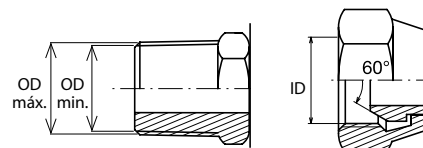

BSP	Male thread OD	Female thread iD
1/4-19	13,16	11,50
3/8-19	16,66	14,90
1/2-14	20,96	18,60
5/8-14	22,91	20,60
3/4-14	26,44	24,10
1-11	33,25	30,30
1 1/4-11	41,91	38,90
1 1/2-11	47,80	44,90
2-11	59,62	56,70

NPT cónicas Conical NPT NPT conique NPT conico	Male thread máx. OD	Male thread mín. OD	Female thread iD	BSPT cónicas Conical BSPT BSPT conique BSPT conico	Male thread máx. OD	Male thread mín OD
1/8-27	10,59	9,98	8,6	1/8-28	10,20	9,48
1/4-18	14,12	13,28	11,9	1/4-19	13,90	12,85
3/8-18	17,55	16,71	15,0	3/8-19	17,31	16,26
1/2-14	21,84	21,08	19,1	1/2-14	21,89	20,55
3/4-14	27,17	26,13	24,6	3/4-14	27,30	25,84
1-11,5	33,96	32,74	30,5	1-11	34,41	32,65
1 1/4-11,5	42,72	41,47	39,4	1 1/4-11	42,91	41,11
1 1/2-11,5	48,81	47,54	45,5	1 1/2-11	48,83	47,08
2-11,5	60,88	59,56	57,4	2-11	60,94	58,62

ORFS

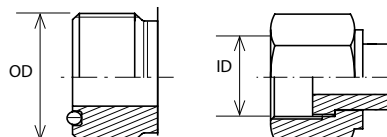

ORFS	Male thread OD	Female thread iD
9/16" 18h	14,25	13,0
11/16" 16h	17,40	15,4
13/16" 16h	20,05	18,6
1" 14h	25,30	23,1
1" 3/16 12h	30,10	27,5
1" 7/16 12h	36,40	33,8
1" 11/16 12h	42,80	40,2
2" 12h	50,70	48,1

BRIDAS

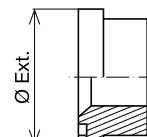

Brida SAE	Ø ext. 3000 PSI	Ø ext. 6000 PSI
1/2"	30,2	31,8
3/4"	38,1	41,3
1"	44,5	47,6
1" 1/4	50,8	54,0
1" 1/2	60,3	63,5
2"	71,4	79,4

* 9000 PSI flanges have the same Ø as 6000 PSI, but with thickness deck 14,3 / Las bridas 9000 PSI son iguales en Ø a las 6000 PSI, pero con espesor de pletina 14,3 / Die Flansche 9000 PSI sind im Ø gleich denen von 6000 PSI, aber mit der Plattendicke 14,3. / Les brides 9000 PSI son égales en Ø aux brides 6000 PSI, mais l'épaisseur est de 14,3 mm.

Adaptadores ORFS

ORFS Adaptors
Adaptateurs ORFS
Adattatori ORFS

Tuerca ORFS

ORFS Nut

Ecrou ORFS

Dado ORFS

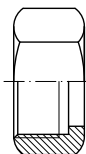

THREAD ROSCA	Part nº Referencia	€
ORFS 9/16"-18h	OR1020400	0,83
ORFS 11/16"-16h	OR1020600	1,17
ORFS 13/16"-16h	OR1020800	1,37
ORFS 1"-14h	OR1021000	1,84
ORFS 1"3/16-12h	OR1021200	5,02
ORFS 1"7/16-12h	OR1021600	5,49
ORFS 1"11/16-12h	OR1022000	10,33
ORFS 2"-12h	OR1022400	11,91

Tapón macho ORFS

ORFS Male plug

Bouchon mâle ORFS

Tappo maschio ORFS

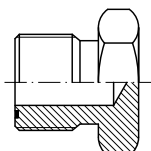

THREAD ROSCA	Part nº Referencia	€
ORFS 9/16"-18h	OR1040400	1,36
ORFS 11/16"-16h	OR1040600	1,67
ORFS 13/16"-16h	OR1040800	2,21
ORFS 1"-14h	OR1041000	2,75
ORFS 1"3/16-12h	OR1041200	4,17
ORFS 1"7/16-12h	OR1041600	6,32
ORFS 1"11/16-12h	OR1042000	8,17
ORFS 2"-12h	OR1042400	20,19

Adaptador macho ORFS

ORFS-ORFS Male

Mâle ORFS-ORFS

Adattatore maschio ORFS

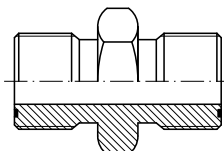

THREAD ROSCA	Part nº Referencia	€	
ORFS 9/16"-18h	ORFS 9/16"-18h	OR2000404	2,35
ORFS 11/16"-16h	ORFS 9/16"-18h	OR2000604	2,61
ORFS 11/16"-16h	ORFS 11/16"-16h	OR2000606	3,00
ORFS 13/16"-16h	ORFS 11/16"-16h	OR2000806	3,91
ORFS 13/16"-16h	ORFS 13/16"-16h	OR2000808	3,91
ORFS 1"-14h	ORFS 13/16"-16h	OR2001008	5,21
ORFS 1"-14h	ORFS 1"-14h	OR2001010	5,27
ORFS 1"3/16-12h	ORFS 1"-14h	OR2001210	6,18
ORFS 1"3/16-12h	ORFS 1"3/16-12h	OR2001212	7,17
ORFS 1"7/16-12h	ORFS 1"3/16-12h	OR2001612	13,89
ORFS 1"7/16-12h	ORFS 1"7/16-12h	OR2001616	10,21
ORFS 1"11/16-12h	ORFS 1"7/16-12h	OR2002016	17,70
ORFS 1"11/16-12h	ORFS 1"11/16-12h	OR2002020	21,78
ORFS 2"-12h	ORFS 2"-12h	OR2002424	30,31

Cono soldar

ORFS Welding cone

Collet à souder ORFS

Ogiva a saldare ORFS

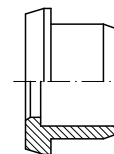

THREAD ROSCA	Part nº Referencia	€
ORFS 9/16"-18h	OR12730406	1,62
ORFS 11/16"-16h	OR12730610	1,47
ORFS 13/16"-16h	OR12730812	1,79
ORFS 1"-14h	OR12731014	2,30
ORFS 1"-14h	OR12731015	2,30
ORFS 1"-14h	OR12731016	2,30
ORFS 1"3/16-12h	OR12731218	2,64
ORFS 1"3/16-12h	OR12731220	2,17
ORFS 1"11/16-12h	OR12732030	10,64
ORFS 2"-12h	OR12732438	11,06

Tapón hembra giratoria ORFS

ORFS Female cap

Bouchon femelle ORFS

Tappo femmina ORFS

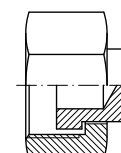

THREAD ROSCA	Part nº Referencia	€
ORFS 9/16"-18h	OR1050400	1,65
ORFS 11/16"-16h	OR1050600	2,15
ORFS 13/16"-16h	OR1050800	2,62
ORFS 1"-14h	OR1051000	3,87
ORFS 1"3/16-12h	OR1051200	5,37
ORFS 1"7/16-12h	OR1051600	6,56
ORFS 1"11/16-12h	OR1052000	13,61
ORFS 2"-12h	OR1052400	19,36

Adaptador reductor hembra giratoria ORFS-macho ORFS

ORFS Swivel female-ORFS Male

Femelle tournante ORFS-mâle ORFS

Adattatore femmina girevole ORFS-maschio ORFS

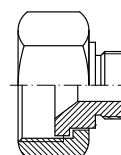

THREAD ROSCA	Part nº Referencia	€	
ORFS 11/16"-16h	ORFS 9/16"-18h	OR3010604	4,36
ORFS 13/16"-16h	ORFS 9/16"-18h	OR3010804	5,72
ORFS 13/16"-16h	ORFS 11/16"-16h	OR3010806	5,47
ORFS 1"-14h	ORFS 9/16"-18h	OR3011004	9,07
ORFS 1"-14h	ORFS 13/16"-16h	OR3011008	9,07
ORFS 1"3/16-12h	ORFS 11/16"-16h	OR3011206	8,17
ORFS 1"3/16-12h	ORFS 13/16"-16h	OR3011208	8,85
ORFS 1"3/16-12h	ORFS 1"-14h	OR3011210	10,93
ORFS 1"7/16-12h	ORFS 13/16"-16h	OR3011608	14,58
ORFS 1"7/16-12h	ORFS 1"-14h	OR3011610	14,58
ORFS 1"11/16-12h	ORFS 1"3/16-12h	OR3012012	19,63
ORFS 1"11/16-12h	ORFS 1"7/16-12h	OR3012016	19,63

Quick-release couplings

Ball valves

Diverters

Swivel fittings

Multi-way couplings

Protections

Adaptadores ORFS

ORFS Adaptors
Adaptateurs ORFS
Adattatori ORFS

Adaptador macho ORFS-BSP

ORFS-BSP Male

Mâle ORFS-BSP

Adattatore maschio ORFS-BSP

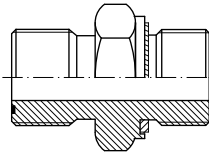

THREAD ROSCA		Part n° Referencia	€
ORFS 9/16"-18h	BSP 1/8"	OR2020402	2,65
ORFS 9/16"-18h	BSP 1/4"	OR2020404	2,62
ORFS 11/16"-16h	BSP 1/4"	OR2020604	2,94
ORFS 11/16"-16h	BSP 3/8"	OR2020606	3,08
ORFS 13/16"-16h	BSP 3/8"	OR2020806	4,07
ORFS 13/16"-16h	BSP 1/2"	OR2020808	4,77
ORFS 1"-14h	BSP 1/2"	OR2021008	5,47
ORFS 1"3/16-12h	BSP 3/4"	OR2021212	7,17
ORFS 1"7/16-12h	BSP 1"	OR2021616	10,89
ORFS 1"11/16-12h	BSP 1"1/4	OR2022020	20,07
ORFS 2"-12h	BSP 1"1/2	OR2022424	45,37

Adaptador macho ORFS-hembra giratoria JIC

ORFS Male-JIC Swivel female

Mâle ORFS-femelle tournante JIC

Adattatore maschio ORFS-femmina girevole JIC

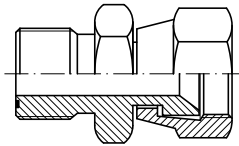

THREAD ROSCA		Part n° Referencia	€
ORFS 9/16"-18h	JIC 7/16"	OR3020404	3,86
ORFS 11/16"-16h	JIC 9/16"	OR3020606	4,64
ORFS 13/16"-16h	JIC 3/4"	OR3020808	4,97
ORFS 1"-14h	JIC 7/8"	OR3021010	12,24
ORFS 1"3/16-12h	JIC 1"1/16	OR3021212	6,70
ORFS 1"7/16-12h	JIC 1"5/16	OR3021616	13,69
ORFS 1"11/16-12h	JIC 1"5/8	OR3022020	24,12
ORFS 2"-12h	JIC 1"7/8	OR3022424	45,80

Macho ORFS-Métrico

ORFS Metric Male

Mâle ORFS Métrique

Maschio ORFS Metrico

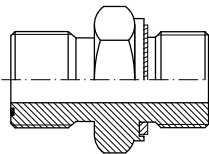

THREAD ROSCA		Part n° Referencia	€
ORFS 9/16"-18h	M12x1.5	OR10170412	5,65
ORFS 11/16"-16h	M14x1.5	OR10170614	4,36
ORFS 11/16"-16h	M16x1.5	OR10170616	4,36
ORFS 13/16"-16h	M18x1.5	OR10170818	4,69
ORFS 1"-14h	M22x1.5	OR10171022	6,08
ORFS 1"7/16-12h	M33x2	OR10171633	12,57
ORFS 1"11/16-12h	M42x2	OR10172042	23,73
ORFS 2"-12h	M48x2	OR10172448	37,02

Adaptador macho ORFS-JIC

ORFS-JIC Male

Mâle ORFS-JIC

Adattatore maschio ORFS-JIC

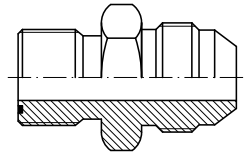

THREAD ROSCA		Part n° Referencia	€
ORFS 9/16"-18h	JIC 7/16"	OR2040404	2,45
ORFS 11/16"-16h	JIC 9/16"	OR2040606	2,65
ORFS 13/16"-16h	JIC 3/4"	OR2040808	3,24
ORFS 1"-14h	JIC 7/8"	OR2041010	4,71
ORFS 1"3/16-12h	JIC 1"1/16	OR2041212	7,06
ORFS 1"7/16-12h	JIC 1"5/16	OR2041616	9,15

Pasatabiques ORFS

ORFS Bulkhead

Passe-doisson ORFS

Passaparete ORFS

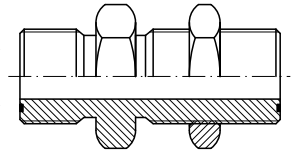

PIPE TUBO	THREAD ROSCA	Part n° Referencia	€
5	ORFS 9/16"-18h	OR1060404	4,77
6,5	ORFS 11/16"-16h	OR1060606	6,13
9,5	ORFS 13/16"-16h	OR1060808	8,17
12,5	ORFS 1"-14h	OR1061010	9,52
15,5	ORFS 1"3/16-12h	OR1061212	14,30
20,5	ORFS 1"7/16-12h	OR1061616	24,22
26	ORFS 1"11/16-12h	OR1062020	33,27
32	ORFS 2"-12h	OR1062424	53,99

Hembra Giratoria ORFS - Racor Recto Macho BSP

ORFS swivel female - BSP male

Femelle tournante ORFS - Mâle BSP

Femmina girevole ORFS- Adattatore maschio BSP

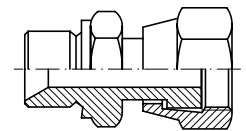

PIPE TUBO	THREAD ROSCA	Part n° Referencia	€	
3,5	1/8" BSP	ORFS 9/16" 18h	OR3030402	10,53
6	1/4" BSP	ORFS 9/16" - 18h	OR3030404	10,63
6	1/4" BSP	ORFS 11/16" - 16h	OR3030604	12,17
8	3/8" BSP	ORFS 11/16" - 16h	OR3030606	13,32
8	3/8" BSP	ORFS 13/16" - 16h	OR3030806	14,92
11	1/2" BSP	ORFS 13/16" - 16h	OR3030808	15,48
11	1/2" BSP	ORFS 1" - 14h	OR3031008	18,89
16	3/4" BSP	ORFS 1"3/16 - 12h	OR3031212	24,62
22	1" BSP	ORFS 1"7/16 - 12h	OR3031616	30,19
28,5	1"1/4 BSP	ORFS 1"11/16 - 12h	OR3032020	38,69
33	1"1/2 BSP	ORFS 2" - 12h	OR3032424	67,84

Adaptadores ORFS

ORFS Adaptors
Adapteurs ORFS
Adattatori ORFS

Hembra Giratoria ORFS - Racor Recto Macho BSP con junta

ORFS swivel female - BSP male with o'ring

Femelle tournante ORFS - Mâle BSP avec o'ring

Femmina girevole ORFS- Adattatore maschio BSP + o'ring

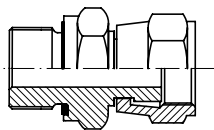

THREAD ROSCA		Part nº Referencia	€
3/8" BSP	ORFS 11/16" - 16h	OR3130606	13,88
1/2" BSP	ORFS 13/16" - 16h	OR3130808	18,36
3/4" BSP	ORFS 1"3/16 - 12h	OR3131212	23,05
1" BSP	ORFS 1"7/16 - 12h	OR3131616	37,91

Adaptador Macho ORFS - Hembra Fija BSP

ORFS male adaptor - BSP fixed female

Adapteur mâle ORFS - femelle fixe BSP

Adattatore maschio ORFS - femmina fissa BSP

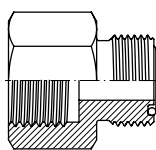

THREAD ROSCA		Part nº Referencia	€
ORFS 9/16"-18 h	BSP 1/4"	OR3040404	3,33
ORFS 11/16"-16h	BSP 3/8"	OR3040606	4,03
ORFS 13/16"-16 h	BSP 1/2"	OR3040808	4,73
ORFS 1"3/16-12 h	BSP 3/4"	OR3041212	8,45
ORFS 1"7/16-12 h	BSP 1"	OR3041616	12,10

Codo 45° regulable ORFS-BSP

45° elbow ORFS male-Adjustable BSP male

Coude 45° mâle ORFS-mâle gaz cyl. +o'ring

Raccordo a 45° orientabile ORFS-BSP

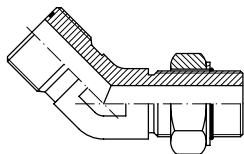

THREAD ROSCA		Part nº Referencia	€
ORFS 9/16"-18h	BSP 1/8"	OR5010402	6,08
ORFS 9/16"-18h	BSP 1/4"	OR5010404	5,96
ORFS 11/16"-16h	BSP 1/4"	OR5010604	7,26
ORFS 11/16"-16h	BSP 3/8"	OR5010606	7,75
ORFS 11/16"-16h	BSP 1/2"	OR5010608	9,71
ORFS 13/16"-16h	BSP 3/8"	OR5010806	8,85
ORFS 1"-14h	BSP 1/2"	OR5011008	13,44
ORFS 1"-14h	BSP 3/4"	OR5011012	17,16
ORFS 1"3/16-12h	BSP 3/4"	OR5011212	19,07
ORFS 1"3/16-12h	BSP 1"	OR5011216	26,29
ORFS 1"7/16-12h	BSP 1"	OR5011616	29,77

Adaptador H.G. ORFS - Macho JIC

ORFS swivel female adaptor - JIC male

Adapteur femelle tournante ORFS - mâle JIC

Adattatore femmina girevole ORFS - maschio JIC

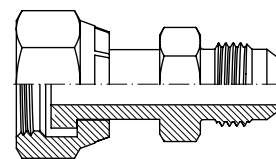

THREAD ROSCA		Part nº Referencia	€
JIC 7/16	ORFS 9/16"-18 h	OR3050404	3,95
JIC 9/16	ORFS 11/16"-16h	OR3050606	5,04
JIC 3/4"	ORFS 13/16"-16 h	OR3050808	6,36
JIC 1"1/16	ORFS 1"3/16-12 h	OR3051212	11,55
JIC 1" 5/16	ORFS 1"7/16-12 h	OR3051616	17,14

Codo 45° macho ORFS-hembra giratoria ORFS

45° elbow ORFS swivel female-ORFS male

Coude 45° mâle ORFS-femelle tournante ORFS

Raccordo a 45° maschio-femmina girevole ORFS

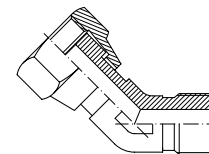

THREAD ROSCA		Part nº Referencia	€
ORFS 9/16"-18h	ORFS 9/16"-18h	OR6010404	6,52
ORFS 11/16"-16h	ORFS 11/16"-16h	OR6010606	8,44
ORFS 13/16"-16h	ORFS 13/16"-16h	OR6010808	10,42
ORFS 1"-14h	ORFS 1"-14h	OR6011010	13,61
ORFS 1"3/16-12h	ORFS 1"3/16-12h	OR6011212	19,55
ORFS 1"7/16-12h	ORFS 1"7/16-12h	OR6011616	32,87
ORFS 1"11/16	ORFS 1"11/16	OR6012020	44,63
ORFS 2"-12h	ORFS 2"-12h	OR6012424	52,18

Quick-release couplings

Ball valves

Diverter

Swivel fittings

Multi-way couplings

Protections

Adaptadores ORFS

ORFS Adaptors
Adaptateurs ORFS
Adattatori ORFS

Codo 90° ORFS-ORFS

90° Elbow ORFS male-ORFS male

Coude 90° mâle ORFS-mâle ORFS

Raccordo a 90° ORFS-ORFS

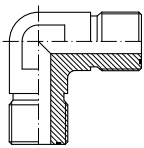

THREAD ROSCA		Part n° Referencia	€
ORFS 9/16"-18h	ORFS 9/16"-18h	OR4050404	8,18
ORFS 11/16"-16h	ORFS 11/16"-16h	OR4050606	8,72
ORFS 13/16"-16h	ORFS 13/16"-16h	OR4050808	10,65
ORFS 1"-14h	ORFS 1"-14h	OR4051010	13,53
ORFS 1"3/16-12h	ORFS 1"3/16-12h	OR4051212	15,94
ORFS 1"7/16-12h	ORFS 1"7/16-12h	OR4051616	47,94
ORFS 1"11/16-12h	ORFS 1"11/16-12h	OR4052020	46,61
ORFS 2"-12h	ORFS 2"-12h	OR4052424	56,33

Codo 90° macho-hembra giratoria ORFS

90° Elbow ORFS Swivel female-ORFS male

Coude 90° femelle tournante-mâle ORFS

Raccordo a 90° maschio-femmina girevole ORFS

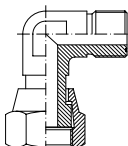

THREAD ROSCA		Part n° Referencia	€
ORFS 9/16"-18h	ORFS 9/16"-18h	OR6000404	5,72
ORFS 11/16"-16h	ORFS 11/16"-16h	OR6000606	7,49
ORFS 13/16"-16h	ORFS 13/16"-16h	OR6000808	8,10
ORFS 1"-14h	ORFS 1"-14h	OR6001010	11,92
ORFS 1"3/16-12h	ORFS 1"3/16-12h	OR6001212	17,43
ORFS 1"7/16-12h	ORFS 1"7/16-12h	OR6001616	20,82
ORFS 1"11/16-12h	ORFS 1"11/16-12h	OR6002020	40,76

Codo 90° pasatabique ORFS

90° Elbow ORFS Bulkhead

Coude 90° passe-cloison ORFS

Raccordo a 90° passaparete ORFS

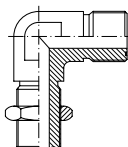

THREAD ROSCA		Part n° Referencia	€
ORFS 9/16"-18h	ORFS 9/16"-18h	OR4030404	17,57
ORFS 11/16"-16h	ORFS 11/16"-16h	OR4030606	16,83
ORFS 1"-14h	ORFS 1"-14h	OR4031010	28,48
ORFS 1"3/16-12h	ORFS 1"3/16-12h	OR4031212	36,10
ORFS 1"7/16-12h	ORFS 1"7/16-12h	OR4031616	58,55
ORFS 1"11/16-12h	ORFS 1"11/16-12h	OR4032020	53,75
ORFS 2"-12h	ORFS 2"-12h	OR4032424	89,97

Codo 90° ORFS-BSP macho regulable

90° elbow ORFS male-Adjustable BSP male

Coude 90° mâle ORFS + mâle gaz cyl. +o'ring

Raccordo a 90° regolabile ORFS-BSP

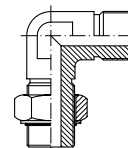

THREAD ROSCA		Part n° Referencia	€
ORFS 9/16"-18h	BSP 1/8"	OR4010402	11,01
ORFS 9/16"-18h	BSP 1/4"	OR4010404	10,86
ORFS 9/16"-18h	BSP 3/8"	OR4010406	18,95
ORFS 11/16"-16h	BSP 1/4"	OR4010604	10,16
ORFS 11/16"-16h	BSP 3/8"	OR4010606	11,34
ORFS 13/16"-16h	BSP 1/4"	OR4010804	10,75
ORFS 13/16"-16h	BSP 1/2"	OR4010808	15,70
ORFS 1"-14h	BSP 3/8"	OR4011006	15,34
ORFS 1"-14h	BSP 1/2"	OR4011008	14,98
ORFS 1"3/16-12h	BSP 1/2"	OR4011208	18,95
ORFS 1"3/16-12h	BSP 3/4"	OR4011212	19,94
ORFS 1"3/16-12h	BSP 1"	OR4011216	42,28
ORFS 1"7/16-12h	BSP 1"	OR4011616	34,10
ORFS 1"7/16-12h	BSP 1" 1/4	OR4011620	55,73
ORFS 1"11/16-12h	BSP 1"	OR4012016	48,18
ORFS 1"11/16-12h	BSP 1" 1/4	OR4012020	55,73
ORFS 2"-12h	BSP 1" 1/2	OR4012424	71,21

Codo 90° Macho ORFS - Macho NPT (60°)

90° Elbow ORFS male - NPT male (60°)

Coude 90° mâle ORFS - mâle NPT (60°)

Raccordo a 90° maschio ORFS - maschio NPT (60°)

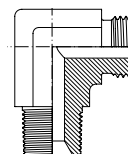

THREAD ROSCA		Part n° Referencia	€
ORFS 9/16"-18 h	1/4" NPT	OR4040404	4,27
ORFS 11/16"-16h	3/8" NPT	OR4040606	5,82
ORFS 13/16"-16 h	1/2" NPT	OR4040808	8,92
ORFS 1"3/16-12 h	3/4" NPT	OR4041212	18,22
ORFS 1"7/16-12 h	1" NPT	OR4041616	27,29

Adaptadores ORFS

ORFS Adaptors
Adapteurs ORFS
Adattatori ORFS

Te Macho ORFS

Tee ORFS male

Té égal mâle ORFS

Raccordo a T maschio ORFS

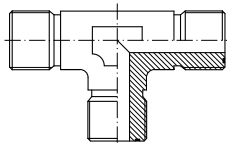

THREAD ROSCA	Part nº Referencia	€
ORFS 9/16"-18h	OR7000404	9,44
ORFS 11/16"-16h	OR7000606	12,33
ORFS 13/16"-16h	OR7000808	13,18
ORFS 1"-14h	OR7001010	17,50
ORFS 1"3/16-12h	OR7001212	19,19
ORFS 1"7/16-12h	OR7001616	45,89
ORFS 1"11/16-12h	OR7002020	45,48
ORFS 2"-12h	OR7002424	85,42

Te macho-hembra giratoria-macho ORFS

ORFS Brunch tee male-swivel female-male

Té mâle-femelle tournante-mâle ORFS

Raccordo a T maschio-maschio-femmina girevole centrale ORFS

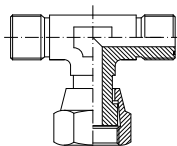

THREAD ROSCA	Part nº Referencia	€
ORFS 9/16"-18h	OR7010404	15,88
ORFS 11/16"-16h	OR7010606	18,95
ORFS 13/16"-16h	OR7010808	17,19
ORFS 1"-14h	OR7011010	26,07
ORFS 1"3/16-12h	OR7011212	34,34
ORFS 1"7/16-12h	OR7011616	64,90
ORFS 1"11/16-12h	OR7012020	94,49
ORFS 2"-12h	OR7012424	142,53

Te macho-macho-hembra giratoria ORFS

ORFS Barrel tee male-male-swivel female

Té mâle-mâle-femelle tournante ORFS

Raccordo a T maschio-maschio-femmina girevole laterale ORFS

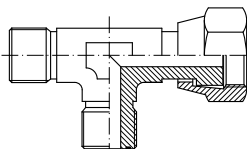

THREAD ROSCA	Part nº Referencia	€
ORFS 9/16"-18h	OR7020404	7,39
ORFS 11/16"-16h	OR7020606	7,99
ORFS 13/16"-16h	OR7020808	12,72
ORFS 1"-14h	OR7021010	15,05
ORFS 1"3/16-12h	OR7021212	21,28
ORFS 1"7/16-12h	OR7021616	36,48
ORFS 1"11/16-12h	OR7022020	62,86

Te macho ORFS-macho BSP-macho ORFS

Brunch tee ORFS male- Adjustable BSP male- ORFS male

Té mâle ORFS-mâle BSP-mâle ORFS

Raccordo a T maschio ORFS-maschio BSP-maschio ORFS

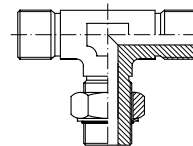

THREAD ROSCA		Part nº Referencia	€
ORFS 9/16"-18h	BSP 1/8"	OR7030402	6,26
ORFS 9/16"-18h	BSP 1/4"	OR7030404	9,52
ORFS 11/16"-16h	BSP 1/4"	OR7030604	9,34
ORFS 11/16"-16h	BSP 3/8"	OR7030606	10,97
ORFS 13/16"-16h	BSP 3/8"	OR7030806	10,06
ORFS 1"-14h	BSP 1/2"	OR7031008	14,96
ORFS 1"-14h	BSP 3/4"	OR7031012	20,49
ORFS 1"3/16-12h	BSP 3/4"	OR7031212	24,13
ORFS 1"7/16-12h	BSP 1"	OR7031616	34,72
ORFS 1"11/16-12h	BSP 1"1/4"	OR7032020	49,23

Te macho ORFS-macho ORFS-macho BSP

Barrel tee ORFS male-ORFS male- Adjustable BSP male

Té mâle ORFS-mâle ORFS-mâle BSP

Raccordo a T maschio ORFS-maschio ORFS-maschio BSP

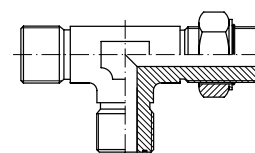

THREAD ROSCA		Part nº Referencia	€
ORFS 9/16"-18h	BSP 1/8"	OR7040402	17,22
ORFS 9/16"-18h	BSP 1/4"	OR7040404	11,50
ORFS 11/16"-16h	BSP 1/4"	OR7040604	14,98
ORFS 11/16"-16h	BSP 3/8"	OR7040606	16,74
ORFS 1"-14h	BSP 3/4"	OR7041012	27,30
ORFS 1"11/16-12h	BSP 1"1/4"	OR7042020	65,71
ORFS 2"-12h	BSP 1"1/2"	OR7042424	65,35

Enchufes rápidos

Quick-release couplings

Coupleurs rapides

Innesti rapidi

Enchufes rápidos DNP

DNP Quick-release couplings

Coupleurs rapides DNP

Innesti rapidi DNP

317

Enchufes rápidos Tr Δ le

Tr Δ le quick-release couplings

Coupleurs rapides Tr Δ le

Innesti rapidi Tr Δ le

325

2

Enchufes rápidos DNP

DNP Quick-release couplings
Coupleurs rapides DNP
Innesti rapidi DNP

■ Enchufes cara plana / Flat face quick release couplings / Coupleurs rapides à clapet face plane / Innesti a faccia piana | 317

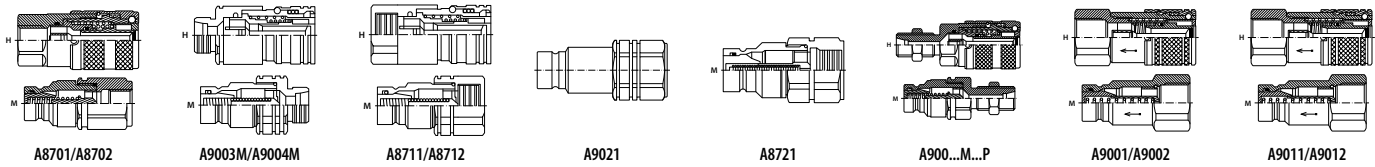

■ Enchufes autorroscantes / Quick release screw couplings / Coupleurs rapides à visser / Innesti a vite | 318

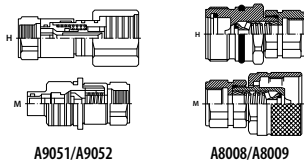

■ Enchufes punzón / Quick release couplings / Coupleurs rapides à clapet / Innesti a valvola | 319

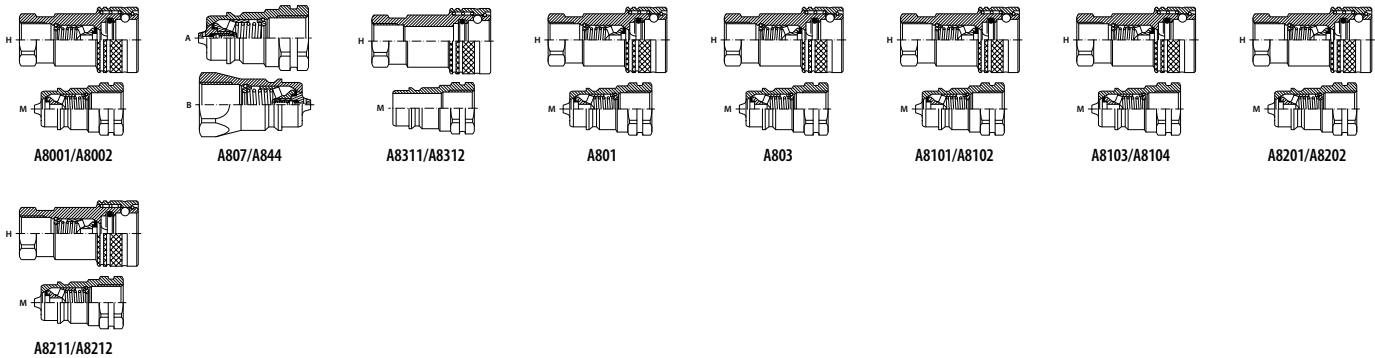

■ Enchufes Push-Pull / Push-Pull couplings / Coupleurs Push-Pull / Innesti Push-Pull | 321

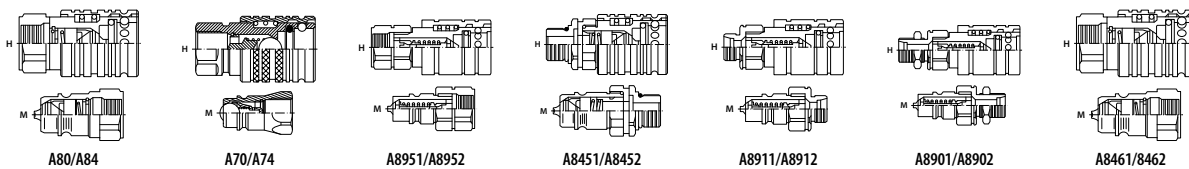

■ Enchufes de bola / Quick release couplings ball type / Coupleurs rapides à bille / Innesti a sfera | 322

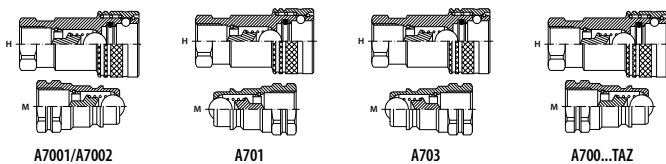

■ Enchufes altísima presión / Couplings 1500 bar / Coupleurs 1500 bar / Innesti 1500 bar | 322

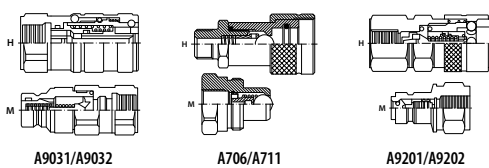

■ Válvulas de frenado / Brake valves / Valves freinaje / Valvole di frenaggio | 323

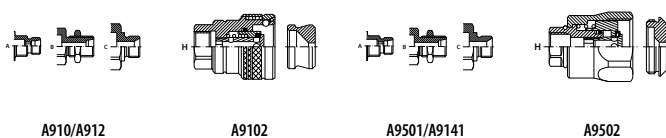

Enchufes rápidos DNP

DNP Quick-release couplings

Coupleurs rapides DNP

Innesti rapidi DNP

■ Enchufes latón / Brass couplings / Coupleurs laiton / Innesti ottone

| 323

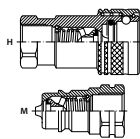

A850



PTFEA



NBRA

■ Accesorios para enchufes / Accessories for couplings / Accessoires pour coupleurs rapides / Accessori per innesto rapido

| 324



A9901/A9902



A9911/A9912



A9931/A9932



A9941/A9942



A9921



A9951/A9952

Enchufes rápidos TrΔle

TrΔle quick-release couplings

Coupleurs rapides TrΔle

Innesti rapidi TrΔle

- Enchufes punzón TrΔle / TrΔle quick release couplings / Coupleurs rapides à clapet TrΔle / Innesti a valvola TrΔle | 325

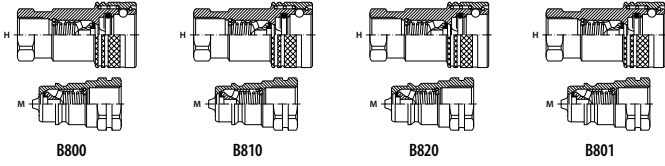

B800

B810

B820

B801

- Enchufes válvula plana y válvulas de frenado TrΔle / TrΔle flat face quick release couplings and brake valves / Coupleurs rapides à clapet face plane TrΔle / Innesti a faccia piana e valvole di frenaggio TrΔle | 325

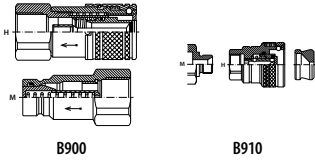

B900

B910

- Enchufes Push-Pull TrΔle / TrΔle Push-Pull couplings / Coupleurs Push-Pull TrΔle / Innesti Push-Pull TrΔle | 326

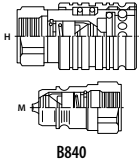

B840

- Accesorios para enchufes TrΔle / Accessories for TrΔle couplings / Accessoires pour coupleurs rapides TrΔle / Accessori per innesto rapido TrΔle | 326

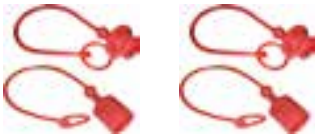

B990

B991

Enchufes rápidos DNP

DNP Quick-release couplings
Coupleurs rapides DNP
Innesti rapidi DNP

E.R. cara plana para martillos BSP

Flat face quick release coupling inner threads BSP

Coupleur rapide à clapet face plane (marteau) BSP

Innesto rapido a faccia piana per martelli BSP

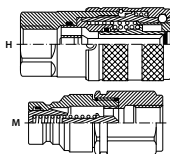

THREAD ROSCA	ISO SIZE TAMAÑO ISO	BG SIZE TAMAÑO BG	C. E.	Part nº Referencia	€
1/4" BSP	6.3	1	M	A870104	17,47
3/8" BSP	10	2	M	A870106	18,86
1/2" BSP	10	2	M	A870108	19,24
1/2" BSP	12.5	3	M	A87011208	33,28
3/4" BSP	12.5	3	M	A870112	34,94
3/4" BSP	16	4A	M	A87011612	33,28
1" BSP	19	4	M	A870116	67,11
1" 1/4 BSP	25	5	M	A870120	110,92
1/4" BSP	6.3	1	F	A870204	36,71
3/8" BSP	10	2	F	A870206	44,76
1/2" BSP	10	2	F	A870208	44,76
1/2" BSP	12.5	3	F	A87021208	68,88
3/4" BSP	12.5	3	F	A870212	60,73
3/4" BSP	16	4A	F	A87021612	83,19
1" BSP	19	4	F	A870216	126,45
1" 1/4 BSP	25	5	F	A870220	206,92

E.R. cara plana para martillos (rosca Métrica)

Flat face coupling (Metric thread)

Coupleur rapide à clapet face plane (filetage Métrique)

Innesto a faccia piana (Metrico)

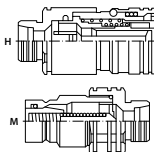

THREAD ROSCA	ISO SIZE TAMAÑO ISO	BG SIZE TAMAÑO BG	C. E.	Part nº Referencia	€
M16X1.5-10L	6.3	1	M	A9003M16	18,84
M18X1.5-12L	10	2	M	A9003M18	19,74
M22X1.5-15L	10	2	M	A9003M22	20,75
M26X1.5-18L	12.5	3	M	A9003M26	41,87
M16X1.5-10L	6.3	1	F	A9004M16	51,08
M18X1.5-12L	10	2	F	A9004M18	57,42
M22X1.5-15L	10	2	F	A9004M22	60,41
M26X1.5-18L	12.5	3	F	A9004M26	86,12

E.R. cara plana para martillos (rosca UNF)

Flat face quick release coupling inner threads (UNF thread)

Coupleur rapide à clapet face plane pour marteau (filetage UNF)

Innesto rapido a faccia piana per martelli (filetatura UNF)

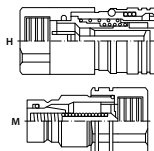

THREAD ROSCA	ISO SIZE TAMAÑO ISO	BG SIZE TAMAÑO BG	C. E.	Part nº Referencia	€
9/16"-18h UNF	6.3	1	M	A87110906	17,47
9/16"-18h UNF	10	2	M	A87110913	18,58
3/4"-16h UNF	10	2	M	A87111213	26,62
7/8"-14h UNF	12.5	3	M	A87111420	38,82
1"1/16-12h UNF	16	3	M	A87111722	40,76
1"1/16-12h UNF	19	4	M	A87111725	67,11
9/16"-18h UNF	6.3	1	F	A87120906	46,59
9/16"-18h UNF	10	2	F	A87120913	56,01
3/4"-16h UNF	10	2	F	A87121213	59,90
7/8"-14h UNF	12.5	3	F	A87121420	84,85
1"1/16-12h UNF	16	3	F	A87121722	93,17
1"1/16-12h UNF	19	4	F	A87121725	139,76

E.R. cara plana Ecológico acoplamiento en presión BSP

Flat face quick release coupling connectable w/ pressure BSP

Coupleur rapide à clapet face plane "Ecologique" pression BSP

Innesto rapido a faccia piana Ecologica innestabile in pressione BSP

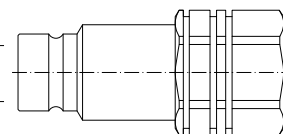

THREAD ROSCA	ISO SIZE TAMAÑO ISO	BG SIZE TAMAÑO BG	C. E.	Part nº Referencia	€
1/4" BSP	6.3	1	M	A902104	69,32
3/8" BSP	10	2	M	A902106	66,55
1/2" BSP	10	2	M	A902108	66,55
1/2" BSP	12.5	3	M	A90211208	108,14
3/4" BSP	12.5	3	M	A902112	108,14
3/4" BSP	19	4	M	A90211612	151,40
1" BSP	19	4	M	A902116	154,73

Se montan con enchufe hembra A870 / To assemble with female coupling A870 / À monter avec coupleur femelle A870 / Per montare con innesto femmina A870

E.R. cara plana para martillos altas pulsaciones BSP

Flat face quick release coupling inner threads high pulsations BSP

Coupleur rapide à clapet face plane (marteau) hautes pulsations BSP

Innesto rapido a faccia piana per martelli alti pulsazioni BSP

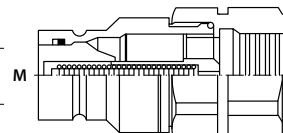

THREAD ROSCA	ISO SIZE TAMAÑO ISO	BG SIZE TAMAÑO BG	C. E.	Part nº Referencia	€
3/4" BSP	19	4	M	A872112	88,73
1" BSP	25	4	M	A872116	88,73

Se montan con enchufe hembra A870 / To assemble with female coupling A870 / À monter avec coupleur femelle A870 / Per montare con innesto femmina A870

E.R. cara plana pasatabique para martillos (rosca Métrica)

Flat face coupling bulkhead (Metric thread)

Coupleur rapide à clapet face plane passe cloison (filetage Métrique)

Innesto a faccia piana passaparete (Metrico)

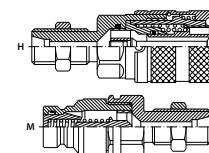

THREAD ROSCA	ISO SIZE TAMAÑO ISO	BG SIZE TAMAÑO BG	C. E.	Part nº Referencia	€
M16x1.5	6.3	1	M	A9001M16P	20,41
M18x1.5	10	2	M	A9001M18P	22,18
M22X1.5	10	2	M	A9001M22P	22,18
M26x1.5	12.5	3	M	A9001M26P	51,85
M16x1.5	6.3	1	F	A9002M16P	54,18
M18x1.5	10	2	F	A9002M18P	61,01
M22X1.5	10	2	F	A9002M22P	64,89
M26x1.5	12.5	3	F	A9002M26P	93,17

Enchufes rápidos DNP

DNP Quick-release couplings
Coupleurs rapides DNP
Innesti rapidi DNP

E.R. cara plana Ecológico (rosca BSP) - ISO16028

BSP Ecological flat face coupling-- ISO16028

Coupleur rapide à clapet face plane
"Ecologique" filetage BSP- ISO16028

Innesto rapido a faccia piana Ecologico BSP--
ISO16028

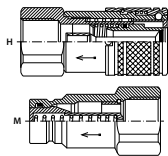

THREAD ROSCA	ISO SIZE TAMAÑO ISO	BG SIZE TAMAÑO BG	C. E.	Part nº Referencia	€
1/4" BSP	6.3	1	M	A900104	16,36
3/8" BSP	10	2	M	A900106	16,64
1/2" BSP	10	2	M	A900108	16,64
1/2" BSP	12.5	3	M	A90011208	37,26
3/4" BSP	12.5	3	M	A900112	35,49
1" BSP	19	4	M	A900116	61,01
1" 1/4 BSP	25	5	M	A900120	116,46
1" 1/2 BSP	40	7	M	A900124	269,53
2" BSP	50	8	M	A900132	686,58
1/4" BSP	6.3	1	F	A900204	34,33
3/8" BSP	10	2	F	A900206	38,82
1/2" BSP	10	2	F	A900208	38,82
1/2" BSP	12.5	3	F	A90021208	70,01
3/4" BSP	12.5	3	F	A900212	55,40
1" BSP	19	4	F	A900216	128,66
1" 1/4 BSP	25	5	F	A900220	205,75
1" 1/2 BSP	40	7	F	A900224	454,76
2" BSP	50	8	F	A900232	987,16

E.R. cara plana Ecológico (rosca NPT)

NPT Ecological flat face coupling

Coupleur rapide à clapet face plane
"Ecologique" filetage NPT

Innesto rapido a faccia piana Ecologico NPT

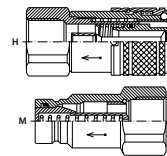

THREAD ROSCA	ISO SIZE TAMAÑO ISO	BG SIZE TAMAÑO BG	C. E.	Part nº Referencia	€
1/4" NPT	6.3	1	M	A901104	16,36
3/8" NPT	10	2	M	A901106	16,64
1/2" NPT	10	2	M	A901108	16,64
3/4" NPT	12.5	3	M	A901112	35,49
1" NPT	19	4	M	A901116	61,01
1" 1/4 NPT	25	5	M	A901120	116,46
1" 1/2 NPT	40	7	M	A901124	232,93
2" NPT	50	8	M	A901132	686,58
1/4" NPT	6.3	1	F	A901204	38,82
3/8" NPT	10	2	F	A901206	40,49
1/2" NPT	10	2	F	A901208	40,49
3/4" NPT	12.5	3	F	A901212	62,11
1" NPT	19	4	F	A901216	146,41
1" 1/4 NPT	25	5	F	A901220	205,75
1" 1/2 NPT	40	7	F	A901224	410,39
2" NPT	50	8	F	A901232	987,16

E.R. cara plana Autorroscantes acoplamiento en presión (rosca BSP)

BSP flat face screw coupling u/pressure

Coupleur rapide à clapet face plane à visser
pression (filetage BSP)

Innesto rapido faccia piana a vite in pressione

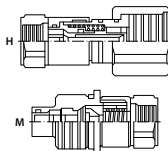

THREAD ROSCA	ISO SIZE TAMAÑO ISO	BG SIZE TAMAÑO BG	C. E.	Part nº Referencia	€
1/4" BSP	6.3	1	M	A905104	117,30
3/8" BSP	10	2	M	A905106	103,15
1/2" BSP	12.5	3	M	A905108	129,22
3/4" BSP	16	4	M	A905112	134,76
1" BSP	19	5	M	A905116	165,27
1" 1/4 BSP	25	6	M	A905120	278,96
1" 1/2 BSP	40	7	M	A905124	561,96
1/4" BSP	6.3	1	F	A905204	88,73
3/8" BSP	10	2	F	A905206	73,76
1/2" BSP	12.5	3	F	A905208	88,73
3/4" BSP	16	4	F	A905212	98,72
1" BSP	19	5	F	A905216	124,78
1" 1/4 BSP	25	6	F	A905220	193,00
1" 1/2 BSP	40	7	F	A905224	640,55

E.R. Punzón Autorroscantes acoplamiento en presión (rosca BSP)

BSP Quick release screw coupling

Coupleur rapide à visser taraudage norme DIN
forme y filetage BSP

Innesto rapido a vite (BSP)

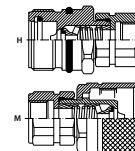

THREAD ROSCA	ISO SIZE TAMAÑO ISO	BG SIZE TAMAÑO BG	C. E.	Part nº Referencia	€
1/4" BSP	M28x2	10	2	M A800804	20,24
3/8" BSP	M28x2	10	2	M A800806	20,24
1/2" BSP	M36x2	12.5	3	M A800808	21,08
3/4" BSP	M42x2	19	4	M A800812	49,36
1" BSP	M48x3	25	5	M A800816	61,56
1" 1/4 BSP	M70x3	31.5T	6	M A805820	227,38
1" 1/2 BSP	M70x3	31.5T	6	M A805824	221,83
1/4" BSP	M28x2	10	2	F A800904	20,24
3/8" BSP	M28x2	10	2	F A800906	20,24
1/2" BSP	M36x2	12.5	3	F A800908	20,35
3/4" BSP	M42x2	19	4	F A800912	47,81
1" BSP	M48x3	25	5	F A800916	52,13
1" 1/4 BSP	M70x3	31.5T	6	F A805920	204,75
1" 1/2 BSP	M70x3	31.5T	6	F A805924	177,47

Enchufes rápidos DNP

DNP Quick-release couplings
Coupleurs rapides DNP
Innesti rapidi DNP

Adaptors

Quick-release couplings

Ball valves

Diverters

Swivel fittings

Multi-way couplings

Protections

E.R. Punzón ISO A

ISO A Quick release coupling

Coupleur rapide à clapet norme ISO A

Innesto rapido a valvola ISO A

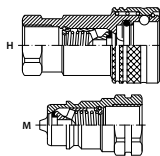

THREAD ROSCA	ISO SIZE TAMAÑO ISO	BG SIZE TAMAÑO BG	C. E.	Part n° Referencia	€
1/4" BSP	6.3	1	M	A800104	6,38
3/8" BSP	10	2	M	A800106	6,71
1/2" BSP	12.5	3	M	A800108	6,71
M22X1.5	12.5	3	M	A802122	7,49
3/4" BSP	20	4	M	A800112	12,76
1" BSP	25	5	M	A800116	29,39
1"1/4 BSP	31.5	6	M	A800120	85,41
1"1/2 BSP	40	7	M	A800124	115,91
2" BSP	50	8	M	A800132	197,43
1/4" BSP	6.3	1	F	A800204	13,31
3/8" BSP	10	2	F	A800206	14,97
1/2" BSP	12.5	3	F	A800208	18,30
3/4" BSP	20	4	F	A800212	27,73
M22X1.5	12.5	3	F	A802222	19,41
1" BSP	25	5	F	A800216	61,01
1"1/4 BSP	31.5	6	F	A800220	175,25
1"1/2 BSP	40	7	F	A800224	236,25
2" BSP	50	8	F	A800232	547,38

E.R. Punzón ISO A -acoplamiento a presión residual

ISO A Quick release coupling (coupling under residual pressure)

Coupleur rapide à clapet accouplable sous pression résiduelle

Innesto rapido a valvole ISO a innestabili in pressione residua

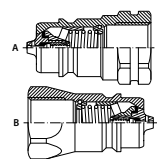

THREAD ROSCA	ISO SIZE TAMAÑO ISO	BG SIZE TAMAÑO BG	C. E.	Part n° Referencia	€
1/2" BSP	12.5	3	M (Tipo B)	A807108	14,97
1/2" BSP	12.5	3	M (Tipo A)	A844108	14,97
1/2" NPT	12.5	3	M (Tipo A)	A806108	14,97

E.R. ISO A Paso total BSP

ISO A Quick release coupling free flow BSP

Coupleur rapide à clapet ISO A pass.total BSP

innesto rapido ISO A passaggio libero BSP

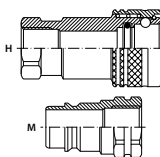

THREAD ROSCA	ISO SIZE TAMAÑO ISO	BG SIZE TAMAÑO BG	C. E.	Part n° Referencia	€
1/4" BSP	6.3	1	M	A831104	3,05
3/8" BSP	10	2	M	A831106	4,99
1/2" BSP	12.5	3	M	A831108	5,82
3/4" BSP	20	4	M	A831112	12,48
1" BSP	25	5	M	A831116	29,39
1"1/4 BSP	31.5	6	M	A831120	61,01
1/4" BSP	6.3	1	F	A831204	11,09
3/8" BSP	10	2	F	A831206	13,20
1/2" BSP	12.5	3	F	A831208	18,86
3/4" BSP	20	4	F	A831212	31,33
1" BSP	25	5	F	A831216	60,45
1"1/4 BSP	31.5	6	F	A831220	133,10

E.R. Punzón ISO A (rosca NPT)

ISO A NPT Quick release coupling

Coupleur rapide à clapet norme ISO A filetage NPT

Innesto rapido a valvola ISO A NPT

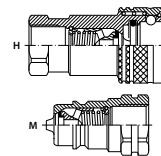

THREAD ROSCA	ISO SIZE TAMAÑO ISO	BG SIZE TAMAÑO BG	C. E.	Part n° Referencia	€
1/4" NPT	6.3	1	M	A801104	6,38
3/8" NPT	10	2	M	A801106	6,71
1/2" NPT	12.5	3	M	A801108	7,43
3/4" NPT	20	4	M	A801112	14,59
1" NPT	25	5	M	A801116	34,39
1"1/4 NPT	31.5	6	M	A801120	83,19
1"1/2 NPT	40	7	M	A801124	115,91
2" NPT	50	8	M	A801132	197,43
1/4" NPT	6.3	1	F	A801204	13,31
3/8" NPT	10	2	F	A801206	14,97
1/2" NPT	12.5	3	F	A801208	19,41
3/4" NPT	20	4	F	A801212	31,61
1" NPT	25	5	F	A801216	63,78
1"1/4 NPT	31.5	6	F	A801220	186,90
1"1/2 NPT	40	7	F	A801224	252,89
2" NPT	50	8	F	A801232	547,38

E.R. Punzón ISO A (rosca UNF)

ISO A UNF Quick release coupling

Coupleur rapide à clapet norme ISO A filetage UNF

Innesto rapido a valvola ISO B UNF

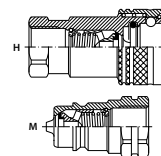

THREAD ROSCA	ISO SIZE TAMAÑO ISO	BG SIZE TAMAÑO BG	C. E.	Part n° Referencia	€
3/4" UNF	12.5	3	M	A803112	7,21
3/4" UNF	12.5	3	F	A803212	19,41

E.R. Punzón ISO B (rosca BSP)

ISO B Quick release coupling (BSP)

Coupleur rapide à clapet norme ISO B (BSP)

Innesto rapido a valvola ISO B (BSP)

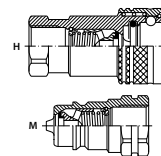

THREAD ROSCA	ISO SIZE TAMAÑO ISO	BG SIZE TAMAÑO BG	C. E.	Part n° Referencia	€
1/8" BSP	5	0	M	A810102	7,21
1/4" BSP	6.3	1	M	A810104	7,21
3/8" BSP	10	2	M	A810106	6,77
1/2" BSP	12.5	3	M	A810108	8,54
3/4" BSP	20	4	M	A810112	17,19
1" BSP	25	5	M	A810116	39,71
1"1/4 BSP	40	7	M	A810120	183,01
1"1/2 BSP	40	7	M	A810124	183,01
2" BSP	50	8	M	A810132	499,13
1/8" BSP	5	0	F	A810202	16,36
1/4" BSP	6.3	1	F	A810204	16,08
3/8" BSP	10	2	F	A810206	18,58
1/2" BSP	12.5	3	F	A810208	28,84
3/4" BSP	20	4	F	A810212	54,46
1" BSP	25	5	F	A810216	92,06
1"1/4 BSP	40	7	F	A810220	246,79
1"1/2 BSP	40	7	F	A810224	248,45
2" BSP	50	8	F	A810232	704,32

Enchufes rápidos DNP

DNP Quick-release couplings
Coupleurs rapides DNP
Innesti rapidi DNP

E.R. Punzón ISO B (rosca NPT)

ISO B NPT Quick release couplings

Coupleur rapide à clapet norme ISO B NPT

Innesto rapido a valvola ISO B NPT

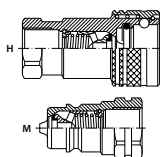

THREAD ROSCA	ISO SIZE TAMAÑO ISO	BG SIZE TAMAÑO BG	C. E.	Part n° Referencia	€
1/8" NPT	5	0	M	A810302	6,66
1/4" NPT	6.3	1	M	A810304	7,21
3/8" NPT	10	2	M	A810306	6,77
1/2" NPT	12.5	3	M	A810308	8,54
3/4" NPT	20	4	M	A810312	17,19
1" NPT	25	5	M	A810316	39,71
1"1/4 NPT	40	7	M	A810320	183,01
1"1/2 NPT	40	7	M	A810324	183,01
2" NPT	50	8	M	A810332	488,04
1/8" NPT	5	0	F	A810402	15,25
1/4" NPT	6.3	1	F	A810404	16,08
3/8" NPT	10	2	F	A810406	18,58
1/2" NPT	12.5	3	F	A810408	28,84
3/4" NPT	20	4	F	A810412	54,46
1" NPT	25	5	F	A810416	92,06
1"1/4 NPT	40	7	F	A810420	249,56
1"1/2 NPT	40	7	F	A810424	249,56
2" NPT	50	8	F	A810432	704,32

E.R. Punzón Serie NV (rosca BSP)

Quick release coupling NV serie

Coupleur rapide à clapet serie NV

Innesto rapido valvola Serie NV

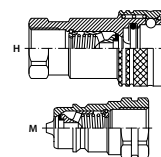

THREAD ROSCA	ISO SIZE TAMAÑO ISO	BG SIZE TAMAÑO BG	C. E.	Part n° Referencia	€
1/4" BSP	6.3	1	M	A820104	6,27
3/8" BSP	10	2	M	A820106	6,88
3/4" BSP	19	4	M	A820112	15,53
1" BSP	25	5	M	A820116	37,71
1"1/4 BSP	31.5	6	M	A820120	81,52
1"1/2 BSP	40	7	M	A820124	115,63
2" BSP	50	8	M	A820132	368,80
1/4" BSP	6.3	1	F	A820204	14,97
3/8" BSP	10	2	F	A820206	17,30
3/4" BSP	19	4	F	A820212	38,82
1" BSP	25	5	F	A820216	72,10
1"1/4 BSP	31.5	6	F	A820220	177,47
1"1/2 BSP	40	7	F	A820224	232,93
2" BSP	50	8	F	A820232	626,68

E.R. Punzón Serie NV (rosca NPT)

NPT Quick release couplings NV1 serie

Coupleur rapide à clapet serie NV 1 NPT

Innesto rapido a valvola serie NV 1 NPT

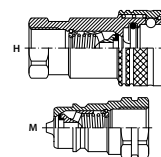

THREAD ROSCA	ISO SIZE TAMAÑO ISO	BG SIZE TAMAÑO BG	C. E.	Part n° Referencia	€
1/4" NPT	6.3	1	M	A821104	7,10
3/8" NPT	10	2	M	A821106	7,10
3/4" NPT	19	4	M	A821112	17,19
1" NPT	25	5	M	A821116	40,21
1"1/4 NPT	31.5	6	M	A821120	81,52
1"1/2 NPT	40	7	M	A821124	115,63
2" NPT	50	8	M	A821132	368,80
1/4" NPT	6.3	1	F	A821204	15,25
3/8" NPT	10	2	F	A821206	17,36
3/4" NPT	19	4	F	A821212	42,15
1" NPT	25	5	F	A821216	72,10
1"1/4 NPT	31.5	6	F	A821220	177,75
1"1/2 NPT	40	7	F	A821224	236,25
2" NPT	50	8	F	A821232	626,68

Enchufes rápidos DNP

DNP Quick-release couplings
Coupleurs rapides DNP
Innesti rapidi DNP

E.R. Push-Pull Punzón ISO A

Push-Pull quick release ISO A

Coupleurs Push-Pull ISO A

Innesto rapido a valvola ISO A

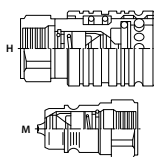

THREAD ROSCA	ISO SIZE TAMAÑO ISO	BG SIZE TAMAÑO BG	C. E.	Part nº Referencia	€
1/2" BSP	12.5	3	M	A840108	7,21
1/2" BSP	12.5	3	F	A840208	20,67
1/2" NPT	12.5	3	F	A841208	20,67
M22X1.5	12.5	3	F	A842222	20,67
3/4" UNF	12.5	3	F	A843234	20,67

E.R. Push-Pull bola ISO A

Push-Pull coupling ball type ISO A

Coupleurs Push-Pull à bille ISO A

Innesto rapido a sfera ISO A

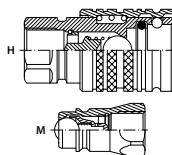

THREAD ROSCA	ISO SIZE TAMAÑO ISO	BG SIZE TAMAÑO BG	C. E.	Part nº Referencia	€
1/2" BSP	12.5	3	M	A704108	9,76
1/2" NPT	12.5	3	M	A705108	9,76
1/2" BSP	12.5	3	F	A740208	22,13
1/2" NPT	12.5	3	F	A741208	22,13
3/4" UNF	12.5	3	F	A702212	22,13

E.R. Push-Pull Punzón aplic.agric. BSP ISO A

Push-Pull quick release coupling agric.application BSP ISO A

Coupleurs Push-Pull à clapet application agricole BSP ISO A

Innesto rapido a valvola applicazioni agricole BSP ISO A

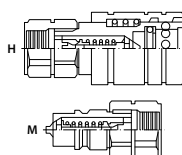

THREAD ROSCA	ISO SIZE TAMAÑO ISO	BG SIZE TAMAÑO BG	C. E.	Part nº Referencia	€
1/4" BSP	6.3	1	M	A895104	28,40
3/8" BSP	10	2	M	A895106	11,65
1/2" BSP	12.5	3	M	A895108	9,15
3/4" BSP	19	4	M	A895112	31,06
1" BSP	25	5	M	A895116	38,27
1/4" BSP	6.3	1	F	A895204	64,22
3/8" BSP	10	2	F	A895206	23,29
1/2" BSP	12.5	3	F	A895208	20,80
3/4" BSP	19	4	F	A895212	95,94
1" BSP	25	5	F	A895216	94,28

E.R. Push-Pull Punzón aplic. agric. SAE ISO A

Push-Pull quick release coupling agric.application SAE ISO A

Coupleurs Push-Pull à clapet application agricole SAE ISO A

Innesto rapido a valvola applicazioni agricole SAE ISO A

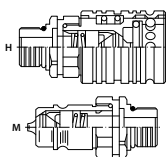

THREAD ROSCA	ISO SIZE TAMAÑO ISO	BG SIZE TAMAÑO BG	C. E.	Part nº Referencia	€
3/4" SAE	12.5	3	M	A845112	10,54
3/4" SAE	12.5	3	F	A845212	24,51

E.R. Push-Pull Punzón aplic. agric. M mét. ISO A

Push-Pull quick release coupling agric.application Met. M ISO A

Coupleurs Push-Pull à clapet application agricole M mét. ISO A

Innesto rapido a valvola applicazioni agricole M Met ISO A

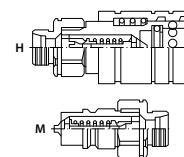

THREAD ROSCA	ISO SIZE TAMAÑO ISO	BG SIZE TAMAÑO BG	C. E.	Part nº Referencia	€
M14X1.5-8L	10	2	M	A89111408	12,20
M16X1.5-10L	10	2	M	A89111610	11,65
M18X1.5-12L	12.5	3	M	A89111812	9,10
M20X1.5-12S	12.5	3	M	A89112012	9,04
M22X1.5-15L	12.5	3	M	A89112215	9,21
M26X1.5-18L	19	4	M	A89112618	31,06
M30X2-22L	19	4	M	A89113022	31,06
M14X1.5-8L	10	2	F	A89121408	23,29
M16X1.5-10L	10	2	F	A89121610	23,29
M18X1.5-12L	12.5	3	F	A89121812	20,41
M20X1.5-12S	12.5	3	F	A89122012	20,41
M22X1.5-15L	12.5	3	F	A89122215	20,41
M26X1.5-18L	19	4	F	A89122618	99,27
M30X2-22L	19	4	F	A89123022	99,27

E.R. Push-Pull Punzón aplic. agric. M mét. pasat ISO A

Push-Pull quick release coupling agric.application Met. M bulkhead ISO A

Coupleurs Push-Pull à clapet application agricole M mét. passe-doisson ISO A

Innesto rapido a valvola applicazioni agricole M Met. pasaparte ISO A

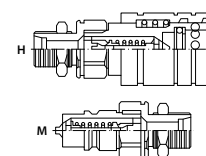

THREAD ROSCA	ISO SIZE TAMAÑO ISO	BG SIZE TAMAÑO BG	C. E.	Part nº Referencia	€
M16X1.5-10L	10	2	M	A89011610	12,20
M18X1.5-12L	12.5	3	M	A89011812	11,42
M22X1.5-15L	12.5	3	M	A89012215	11,42
M16X1.5-10L	10	2	F	A89021610	23,57
M18X1.5-12L	12.5	3	F	A89021812	22,74
M22X1.5-15L	12.5	3	F	A89022215	22,91

E.R. Push-Pull Punzón acoplamiento en presión ISO A

Push-Pull quick release coupling u/ pressure ISO A

Coupleurs Push-Pull à clapet pression ISO A

Innesto rapido a valvola in pressione ISO A

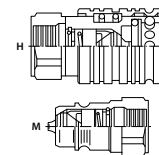

THREAD ROSCA	ISO SIZE TAMAÑO ISO	BG SIZE TAMAÑO BG	C. E.	Part nº Referencia	€
1/2" BSP	12.5	3	M	A8461108	17,19
1/2" NPT	12.5	3	M	A8462108	17,19
M22X1.5	12.5	3	M	A8463122	16,64
3/4" UNF	12.5	3	M	A8464134	23,85
1/2" BSP	12.5	3	F	A8461208	30,50
1/2" NPT	12.5	3	F	A8462208	30,50
M22X1.5	12.5	3	F	A8463222	29,67
3/4" UNF	12.5	3	F	A8464234	37,16

Enchufes rápidos DNP

DNP Quick-release couplings
Coupleurs rapides DNP
Innesti rapidi DNP

E.R. Bola Serie NS (rosca BSP)

BSP Quick release coupling ball type NS Serie

Coupleur rapide à bille série NS

Innesto rapido a sfera BSP Serie NS

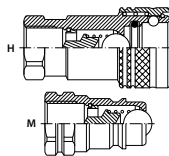

THREAD ROSCA	ISO SIZE TAMAÑO ISO	BG SIZE TAMAÑO BG	C. E.	Part nº Referencia	€
1/4" BSP	6.3	1	M	A700104	6,66
3/8" BSP	10	2	M	A700106	8,43
1/2" BSP	12.5	3	M	A700108	9,43
3/4" BSP	19	4	M	A700112	19,02
1" BSP	25	5	M	A700116	44,64
1/4" BSP	6.3	1	F	A700204	13,42
3/8" BSP	10	2	F	A700206	18,58
1/2" BSP	12.5	3	F	A700208	21,52
3/4" BSP	19	4	F	A700212	42,70
1" BSP	25	5	F	A700216	79,58

E.R. Bola Serie NS (rosca UNF)

UNF Quick release coupling ball type NS Serie

Coupleur rapide à bille filetage UNF série NS

Innesto rapido a sfera UNF serie NS

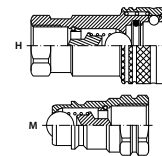

THREAD ROSCA	ISO SIZE TAMAÑO ISO	BG SIZE TAMAÑO BG	C. E.	Part nº Referencia	€
3/4" UNF	12.5	3	M	A703112	9,93
3/4" UNF	12.5	3	F	A703212	21,63

E.R. Bola Tipo Taz (gondolas y semirem.) BSP

Quick release coupling ball type Type Taz (gondolas and semi-tows) BSP

Coupleur rapide à bille Type Taz spécial carrocieres BSP

Innesto rapido a sfera tipo Taz per semirimorchio BSP

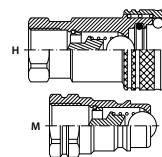

THREAD ROSCA	ISO SIZE TAMAÑO ISO	C. E.	Part nº Referencia	€
3/4" BSP	19	M	A700112TAZ	15,59
1" BSP	25	M	A700116TAZ	23,59
3/4" BSP	19	F	A700212TAZ	36,40
1" BSP	25	F	A700216TAZ	55,04

E.R. Bola Serie NS (rosca NPT)

NPT Quick release coupling ball type NS Serie

Coupleur rapide à bille filetage NPT série NS

Innesto rapido a sfera NPT serie NS

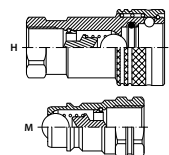

THREAD ROSCA	ISO SIZE TAMAÑO ISO	BG SIZE TAMAÑO BG	C. E.	Part nº Referencia	€
1/4" NPT	6.3	1	M	A701104	6,66
3/8" NPT	10	2	M	A701106	8,43
1/2" NPT	12.5	3	M	A701108	9,43
3/4" NPT	19	4	M	A701112	19,02
1" NPT	25	5	M	A701116	44,64
1/4" NPT	6.3	1	F	A701204	13,42
3/8" NPT	10	2	F	A701206	18,58
1/2" NPT	12.5	3	F	A701208	21,52
3/4" NPT	19	4	F	A701212	42,70
1" NPT	25	5	F	A701216	79,58

E.R. Válvula plana altísima presión 700 bar

Flat face quick release coupling inner threads high pressure 700 bar

Coupleur rapide à clapet face plane (marteau) haute pression 700 bar

Innesto rapido faccia piana altissima pressione 700 bar

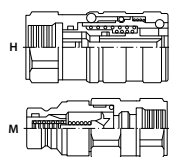

THREAD ROSCA	ISO SIZE TAMAÑO ISO	BG SIZE TAMAÑO BG	C. E.	Part nº Referencia	€
1/4" BSP	6.3	1	M	A903104	38,27
3/8" BSP	6.3	1	M	A903106	56,29
1/4" BSP	6.3	1	F	A903204	69,32
3/8" BSP	6.3	1	F	A903206	119,24

E.R. Bola altísima presión 700 bar

Quick release coupling ball type very high pressure (700 bar)

Coupleur rapide à verrouillage vissé haute pression-700 bar

Innesto rapido a sfera 700 bar

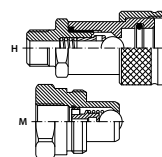

THREAD ROSCA	ISO SIZE TAMAÑO ISO	BG SIZE TAMAÑO BG	C. E.	Part nº Referencia	€
3/8" BSP	10	2	M	A706106	12,20
1/4" NPT	6.3	1	M	A711104	12,26
3/8" NPT	10	2	M	A711106	12,20
3/8" BSP	10	2	F	A706206	30,50
1/4" NPT	6.3	1	F	A711204	18,63
3/8" NPT	10	2	F	A711206	18,23

Enchufes altísima presión 1500 bar BSP

Couplings 1500 bar BSP

Coupleurs 1500 bar BSP

Innesti 1500 bar BSP

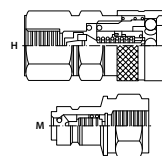

THREAD ROSCA	ISO SIZE TAMAÑO ISO	BG SIZE TAMAÑO BG	C. E.	Part nº Referencia	€
1/4" BSP	6.3	1	M	A920104	46,59
1/4" BSP	6.3	1	F	A920204	120,90

Enchufes rápidos DNP

DNP Quick-release couplings
Coupleurs rapides DNP
Innesti rapidi DNP

Válvula de frenado macho

Male brake valve

Valve freinage mâle

Valvola di frenaggio maschio

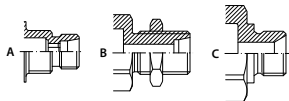

THREAD ROSCA	ISO SIZE TAMAÑO ISO	BG SIZE TAMAÑO BG	C. E.	Part nº Referencia	€
1/2" BSP	-	12.5	3	M (Type C) A910508	15,53
M18X1,5	-	12.5	3	M (Type B) A912118	16,69
M20X1,5	-	12.5	3	M (Type B) A912120	17,03
M22X1,5	-	12.5	3	M (Type B) A912122	17,30
M16x1,5	M20x1,5	12.5	3	M (Type A) A912316	17,47
M18x1,5	M20x1,5	12.5	3	M (Type A) A912318	17,47

Válvula de frenado hembra

Female brake valve

Valve freinage femelle

Valvola di frenaggio femmina

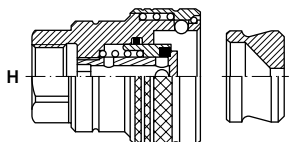

THREAD ROSCA	ISO SIZE TAMAÑO ISO	BG SIZE TAMAÑO BG	C. E.	Part nº Referencia	€
3/8" BSP	12.5	3	F	A910206	30,95
1/2" BSP	12.5	3	F	A910208	30,28
M18X1.5	12.5	3	F	A910218	31,50

E.R. Puzón ISO B (rosca BSP) latón

ISO B Quick release coupling brass

Coupleur rapide à clapet norme ISO B laiton

Innesto rapido a valvola ISO B ottone

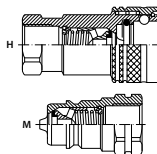

THREAD ROSCA	ISO SIZE TAMAÑO ISO	BG SIZE TAMAÑO BG	C. E.	Part nº Referencia	€
1/4" BSP	6.3	1	M	A850104	12,20
3/8" BSP	10	2	M	A850106	15,53
1/2" BSP	12.5	3	M	A850108	21,63
3/4" BSP	19	4	M	A850112	38,82
1" BSP	25	5	M	A850116	69,88
1"1/4 BSP	40	7	M	A850120	388,21
1"1/2 BSP	40	7	M	A850124	388,21
2" BSP	50	8	M	A850132	909,52
1/4" BSP	6.3	1	F	A850204	31,06
3/8" BSP	10	2	F	A850206	44,37
1/2" BSP	12.5	3	F	A850208	72,10
3/4" BSP	19	4	F	A850212	124,78
1" BSP	25	5	F	A850216	184,68
1"1/4 BSP	40	7	F	A850220	510,22
1"1/2 BSP	40	7	F	A850224	510,22
2" BSP	50	8	F	A850232	1.425,29

Válvula agrícola macho acoplamiento en presión

Male agricultural valve

Valve agricole à visser mâle

Valvola agricola maschio

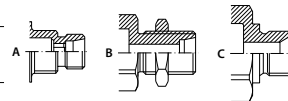

THREAD ROSCA	ISO SIZE TAMAÑO ISO	BG SIZE TAMAÑO BG	C. E.	Part nº Referencia	€	
1/2" BSP	-	M36x2	12.5	3	M (Type C) A950108	16,31
M18x1,5	-	M36x2	12.5	3	M (Type B) A950118	18,08
M20x1,5	-	M36x2	12.5	3	M (Type B) A950120	18,08
M22x1,5	-	M36x2	12.5	3	M (Type B) A950122	18,08
M16x1,5	M20x1,5	M36x2	12.5	3	M (Type A) A9141620	18,41
M18x1,5	M20x1,5	M36x2	12.5	3	M (Type A) A9141820	18,41

Válvula agrícola hembra acoplamiento en presión

Female agricultural valve

Valve agricole à visser femelle

Valvola agricola femmina

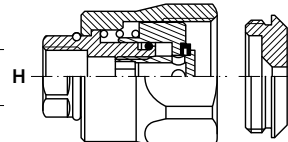

THREAD ROSCA	ISO SIZE TAMAÑO ISO	BG SIZE TAMAÑO BG	C. E.	Part nº Referencia	€
M18X1.5	M36x2	12.5	3	F A950218	27,40

Arandelas PTFE

PTFE seals

Rondelles PTFE

Rondelle a PTFE



ISO SIZE TAMAÑO ISO	BG SIZE TAMAÑO BG	Part nº Referencia	€
6.3	1	PTFEA04	0,78
10	2	PTFEA06	0,91
12.5	3	PTFEA08	0,97
19	4	PTFEA12	1,62
25	5	PTFEA16	1,62

Juego de juntas de reparación e.r. ISO A

Kit of seals to repair for ISO A quick release coupling

Jeu de joints pour coupleur ISO A



Guarnizioni per innesto ISO A

Ø INT.	THICK. ESPESES.	ISO SIZE TAMAÑO ISO	BG SIZE TAMAÑO BG	Part nº Referencia	€
11.91	2.62	6.3	1	NBRA04	0,45
17.12	2.62	10	2	NBRA06	0,58
20.24	2.62	12.5	3	NBRA08	0,71
28.24	2.62	19	4	NBRA12	0,78
34.59	2.62	25	5	NBRA16	0,84

Enchufes rápidos DNP

DNP Quick-release couplings
Coupleurs rapides DNP
Innesti rapidi DNP

Tapones para enchufes rápidos ISO A

Plugs and caps for ISO A quick release couplings

Bouchons et capuchons de plastique pour coupleurs norme ISO A



Tappi per ISO A

ISO SIZE TAMAÑO ISO	BG SIZE TAMAÑO BG	DESCRIPTION DESCRIPCIÓN	C. E.	Part nº Referencia	€
6,3	1	Male plug for female coupling	F	A990104	1,89
10	2	Male plug for female coupling	F	A990106	1,89
12,5	3	Male plug for female coupling	F	A990108	1,55
19	4	Male plug for female coupling	F	A990112	3,49
25	5	Male plug for female coupling	F	A990116	5,82
6,3	1	Cap for male coupling	M	A990204	1,89
10	2	Cap for male coupling	M	A990206	1,89
12,5	3	Cap for male coupling	M	A990208	1,55
19	4	Cap for male coupling	M	A990212	3,49
25	5	Cap for male coupling	M	A990216	5,82

Tapones para enchufes ISO B

Plugs and caps for ISO B quick release coupling

Bouchons et capuchons de plastique pour coupleurs ISO B



Tappi per ISO B

ISO SIZE TAMAÑO ISO	BG SIZE TAMAÑO BG	DESCRIPTION DESCRIPCIÓN	C. E.	Part nº Referencia	€
6,3	1	Male plug for female coupling	F	A991104	2,97
10	2	Male plug for female coupling	F	A991106	2,97
12,5	3	Male plug for female coupling	F	A991108	3,25
19	4	Male plug for female coupling	F	A991112	3,53
25	5	Male plug for female coupling	F	A991116	4,95
6,3	1	Cap for male coupling	M	A991204	2,97
10	2	Cap for male coupling	M	A991206	2,97
12,5	3	Cap for male coupling	M	A991208	3,25
19	4	Cap for male coupling	M	A991212	3,53
25	5	Cap for male coupling	M	A991216	4,95

Tapones para enchufes de válvula plana ISO 16028

Plugs and caps for flat face quick release couplings ISO 16028

Bouchons et capuchons de plastique pour coupleurs face plane ISO 16028



Tappi per innesti a faccia piana ISO 16028

ISO SIZE TAMAÑO ISO	BG SIZE TAMAÑO BG	DESCRIPTION DESCRIPCIÓN	C. E.	Part nº Referencia	€
6,3	1	Male plug for female coupling	H	A993104	3,71
10	2	Male plug for female coupling	H	A993106	2,97
10	2	Male plug for female coupling	H	A993108	2,97
19	3	Male plug for female coupling	H	A993112	3,77
25	4	Male plug for female coupling	H	A993116	5,23
30	5	Male plug for female coupling	H	A993120	7,07
6,3	1	Cap for male coupling	M	A993204	3,75
10	2	Cap for male coupling	M	A993206	2,97
12,5	2	Cap for male coupling	M	A993208	2,97
19	3	Cap for male coupling	M	A993212	3,77
25	4	Cap for male coupling	M	A993216	4,95
30	5	Cap for male coupling	M	A993220	7,07

Tapones para enchufes autorroscantes ISO 14541

Plugs and caps for quick release screw coupling ISO 14541

Bouchon pour coupleur rapide à visser ISO 14541



Tappi per innesti rapidi a vite ISO 14541

ISO SIZE TAMAÑO ISO	BG SIZE TAMAÑO BG	DESCRIPTION DESCRIPCIÓN	C. E.	Part nº Referencia	€
6,3	1	Male plug for female coupling	F	A994104	5,55
10	2	Male plug for female coupling	F	A994106	5,55
12,5	3	Male plug for female coupling	F	A994108	4,99
19	4	Male plug for female coupling	F	A994112	6,43
25	5	Male plug for female coupling	F	A994116	5,55
6,3	1	Cap for male coupling	M	A994204	5,55
10	2	Cap for male coupling	M	A994206	5,55
12,5	3	Cap for male coupling	M	A994208	5,82
19	4	Cap for male coupling	M	A994212	6,43
25	5	Cap for male coupling	M	A994216	5,55

Tapones para enchufes altísima presión ISO 14540

Plugs and caps for quick release coupling very high pressure ISO 14540

Bouchon pour coupleur rapide très haute pression ISO 14540



Tappi per innesti rapidi alta pressione ISO 14540

ISO SIZE TAMAÑO ISO	BG SIZE TAMAÑO BG	Part nº Referencia	€
10	2	A992106	7,21

Tapones para enchufes NV

Plugs and caps for NV quick release coupling

Bouchons et capuchons de plastique pour coupleurs NV



Tappi per ISO NV

ISO SIZE TAMAÑO ISO	BG SIZE TAMAÑO BG	DESCRIPTION DESCRIPCIÓN	Part nº Referencia	€
6,3	1	Male plug for female coupling	A995104	2,50
10	2	Male plug for female coupling	A995106	2,50
19	4	Male plug for female coupling	A995112	1,94
25	5	Male plug for female coupling	A995116	1,66
6,3	1	Cap for male coupling	A995204	2,50
10	2	Cap for male coupling	A995206	2,50
19	4	Cap for male coupling	A995212	1,94
25	5	Cap for male coupling	A995216	1,66

Enchufes rápidos TrΔle

TrΔle quick-release couplings

Coupleurs rapides TrΔle

Innesti rapidi TrΔle

Adaptors

Quick-release couplings

Ball valves

Diverters

Swivel fittings

Multi-way couplings

Protections

E.R. Punzón ISO A BSP

ISO A Quick release coupling BSP

Coupleur rapide à clapet norme ISO A BSP

Innesto rapido a valvula ISO A BSP

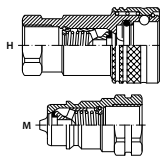

THREAD ROSCA	ISO SIZE TAMAÑO ISO	BG SIZE TAMAÑO BG	C. E.	Part nº Referencia	€
1/4" BSP	6.3	1	M	B800104	4,40
3/8" BSP	10	2	M	B800106	5,03
1/2" BSP	12.5	3	M	B800108	5,84
3/4" BSP	20	4	M	B800112	9,61
1" BSP	25	5	M	B800116	16,34
1/4" BSP	6.3	1	F	B800204	9,43
3/8" BSP	10	2	F	B800206	11,00
1/2" BSP	12.5	3	F	B800208	13,58
3/4" BSP	20	4	F	B800212	22,50
1" BSP	25	5	F	B800216	38,72

E.R. Punzón ISO B BSP

ISO B Quick release coupling BSP

Coupleur rapide à clapet norme ISO B BSP

Innesto rapido a valvula ISO B BSP

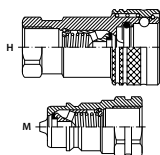

THREAD ROSCA	ISO SIZE TAMAÑO ISO	BG SIZE TAMAÑO BG	C. E.	Part nº Referencia	€
1/4" BSP	06	1	M	B810104	4,84
3/8" BSP	10	2	M	B810106	5,53
1/2" BSP	13	3	M	B810108	6,41
3/4" BSP	19	4	M	B810112	10,62
1" BSP	25	5	M	B810116	16,72
1/4" BSP	06	1	F	B810204	10,37
3/8" BSP	10	2	F	B810206	12,13
1/2" BSP	13	3	F	B810208	14,96
3/4" BSP	19	4	F	B810212	24,76
1" BSP	25	5	F	B810216	38,97

E.R. Válvula plana Ecológico BSP

Ecological flat face coupling BSP

Coupleur rapide à clapet face plane
"Ecologique" BSP

Innesto rapido a faccia piana Ecologico BSP

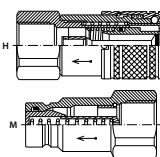

THREAD ROSCA	ISO SIZE TAMAÑO ISO	BG SIZE TAMAÑO BG	C. E.	Part nº Referencia	€
1/4" BSP	06	1	M	B900104	10,12
3/8" BSP	10	2	M	B900106	15,09
1/2" BSP	12	3	M	B900108	22,63
3/4" BSP	-	-	M	B900112	27,66
1" BSP	19	4	M	B900116	42,56
1/4" BSP	06	1	F	B900204	26,34
3/8" BSP	10	2	F	B900206	35,20
1/2" BSP	12	3	F	B900208	46,52
3/4" BSP	-	-	F	B900212	64,42
1" BSP	19	4	F	B900216	99,37

E.R. Punzón Serie NV BSP

Quick release coupling NV Serie BSP

Coupleur rapide à clapet Serie NV BSP

Innesto rapido a valvula Serie NV BSP

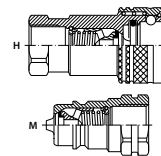

THREAD ROSCA	ISO SIZE TAMAÑO ISO	BG SIZE TAMAÑO BG	C. E.	Part nº Referencia	€
1/4" BSP	6.3	1	M	B820104	4,72
3/8" BSP	10	2	M	B820106	5,41
3/4" BSP	20	4	M	B820112	10,31
1" BSP	25	5	M	B820116	16,28
1/4" BSP	6.3	1	F	B820204	10,12
3/8" BSP	10	2	F	B820206	11,75
3/4" BSP	20	4	F	B820212	24,07
1" BSP	25	5	F	B820216	37,90

E.R. Punzón ISO A (rosca NPT)

ISO A Quick release coupling NPT

Coupleur rapide à clapet norme ISO A NPT

Innesto rapido a valvula ISO A NPT

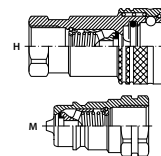

THREAD ROSCA	ISO SIZE TAMAÑO ISO	BG SIZE TAMAÑO BG	C. E.	Part nº Referencia	€
1/4" NPT	6.3	1	M	B801104	4,40
3/8" NPT	10	2	M	B801106	5,03
1/2" NPT	12.5	3	M	B801108	6,17
3/4" NPT	20	4	M	B801112	9,62
1" NPT	25	5	M	B801116	16,34
1/4" NPT	6.3	1	F	B801204	9,43
3/8" NPT	10	2	F	B801206	11,00
1/2" NPT	12.5	3	F	B801208	13,58
3/4" NPT	20	4	F	B801212	22,50
1" NPT	25	5	F	B801216	38,72

Válvulas de frenado BSP

Brake valves BSP

Valves freinage BSP

Valvole di frenaggio BSP

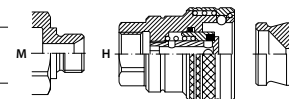

THREAD ROSCA	ISO SIZE TAMAÑO ISO	BG SIZE TAMAÑO BG	C. E.	Part nº Referencia	€
1/2" BSP	10	3	M	B910508	10,18
1/2" BSP	10	3	F	B910208	22,63

Enchufes rápidos TrΔle

TrΔle quick-release couplings

Coupleurs rapides TrΔle

Innesti rapidi TrΔle

E.R. Push-Pull Punzón TrΔle BSP

TrΔle Push-Pull couplings BSP

Coupleurs Push-Pull TrΔle BSP

Innesti Push-Pull TrΔle BSP

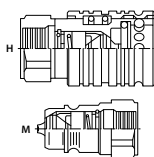

THREAD ROSCA	ISO SIZE TAMAÑO ISO	BG SIZE TAMAÑO BG	C. E.	Part nº Referencia	€
1/2" BSP	12.5	3	M	B840108	5,53
1/2" BSP	12.5	3	H	B840208	15,46

Tapones para enchufes rápidos ISO A

Plugs and caps for ISO A quick release couplings

Bouchons et capuchons de plastique pour coupleurs norme ISO A

Tappi per ISO A



ISO SIZE TAMAÑO ISO	BG SIZE TAMAÑO BG	DESCRIPTION DESCRIPCIÓN	C. E.	Part nº Referencia	€
6.3	1	Male plug for female coupling	H	B990104	0,50
10	2	Male plug for female coupling	H	B990106	0,64
12.5	3	Male plug for female coupling	H	B990108	1,07
20	4	Male plug for female coupling	H	B990112	1,43
25	5	Male plug for female coupling	H	B990116	1,65
6.3	1	Cap for male coupling	M	B990204	0,50
10	2	Cap for male coupling	M	B990206	0,64
12.5	3	Cap for male coupling	M	B990208	1,07
20	4	Cap for male coupling	M	B990212	1,43
25	5	Cap for male coupling	M	B990216	1,65

Tapones para enchufes rápidos ISO B

Plugs and caps for ISO B quick release couplings

Bouchons et capuchons de plastique pour coupleurs norme ISO B

Tappi per ISO B



ISO SIZE TAMAÑO ISO	BG SIZE TAMAÑO BG	DESCRIPTION DESCRIPCIÓN	C. E.	Part nº Referencia	€
6.3	1	Male plug for female coupling	H	B991104	0,57
10	2	Male plug for female coupling	H	B991106	0,72
12.5	3	Male plug for female coupling	H	B991108	1,22
20	4	Male plug for female coupling	H	B991112	1,58
25	5	Male plug for female coupling	H	B991116	1,86
6.3	1	Cap for male coupling	M	B991204	0,57
10	2	Cap for male coupling	M	B991206	0,72
12.5	3	Cap for male coupling	M	B991208	1,22
20	4	Cap for male coupling	M	B991212	1,58
25	5	Cap for male coupling	M	B991216	1,86

ACERO INOXIDABLE

STAINLESS STEEL



CONEXIONES PARA FLEXIBLES
 TUBO RÍGIDO
 RACORES DIN 2353
 RACORES JIC 37°
 BRIDAS SAE
 RACORES SOLDABLES
 ADAPTADORES BSP
 ADAPTADORES NPT
 ADAPTADORES O´RING BOSS
 ADAPTADORES ORFS
 RACORES INDUSTRIALES
 ENCHUFES RÁPIDOS
 LLAVES DE PASO
 COMPONENTES HIDRÁULICOS



CRIMP FITTINGS FOR HOSES
 RIGID PIPE
 DIN 2353 PIPE FITTINGS
 FLARE FITTINGS JIC 37°
 SAE FLANGES
 WELDING FITTINGS
 BSP ADAPTORS
 NPT ADAPTORS
 O´RING BOSS ADAPTORS
 ORFS ADAPTORS
 INDUSTRIAL FITTINGS
 QUICK COUPLINGS
 BALL VALVES
 HYDRAULIC COMPONENTS



Llaves de paso

Ball valves

Robinets

Rubinetti

Llaves de paso alta presión

Ball valves high pressure
Robinets haute pression
Rubinetti a sfera alta pressione

333

Llaves de paso baja presión

Low pressure Ball valves
Robinets Basse pression
Rubinetti Bassa pressione

337

Llaves de paso alta presión TrΔle

TrΔle Ball Valves
Robinets TrΔle haute pression
Rubinetti a sfera TrΔle

338

3

Llaves de paso alta presión

Ball valves high pressure
 Robinets haute pression
 Rubinetti a sfera alta pressione

- De 2 vías / 2 Ways ball valve / Robinets haute pression 2 voies / Rubinetti a sfera 2 vie | 333



BKH G

BKH L

BKH S

BKH G NPT

BKH L DN

BKH S DN

BKH G DN

- De 3 vías / 3 Ways ball valve / Robinets haute pression 3 voies / Rubinetti a sfera 3 vie | 334



BK3 G

3KH G

BK3 GT

BK3 NPT

A600

- De 4 vías / 4 Ways ball valve / Robinets haute pression 4 voies / Rubinetti a sfera 4 vie | 334



4KH G

- Útil para cierre con candado / Locking devices / Dispositifs de verrouillage / Dispositivi di bloccaggio | 335



CANDT2

CANDT4

- Llaves especiales y complementos / Special ball valves and accessories / Robinets spéciaux et compléments / Rubinetti speciali e accessori | 335



A60013/LR

Llaves de paso baja presión

Low pressure Ball valves
 Robinets Basse pression
 Rubinetti Bassa pressione

- Llave de esfera baja presión / 2 Ways ball valve low pressure / Robinet basse pression 2 voies boisseau sphérique pn 16/25 / Rubinetto a sfera bassa pressione

337



BP2V

- Llave de esfera baja presión anti-hielo / 2 Ways ball valve low pressure non frozen / Robinet basse pression 2 voies boisseau sphérique pn 25 anti-gel / Rubinetto a sfera, anti-gelo

337



BP2VA

Adaptors

Quick-release
couplings

Ball valves

Diverters

Swivel fittings

Multi-way couplings

Protections

Llaves de paso alta presión TrΔle

TrΔle Ball Valves

Robinets TrΔle haute pression

Rubinetti a sfera TrΔle

- De 2 vías / 2 ways / 2 voies / Due vie

| 338



GB2V

GB2V_NPT

GB2V_L

GB2V_S

- De 3 vías / 3 ways / 3 voies / Tre vie

| 338

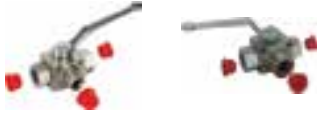

GB3V

GB3VH

Llaves de paso alta presión

Ball valves high pressure
Robinetts haute pression
Rubinetti a sfera alta pressione

Adaptors

Quick-release couplings

Ball valves

Diverters

Swivel fittings

Multi-way couplings

Protections

Llave 2 vías rosca hembra BSP

2 Ways ball valve BSP female

Robinet haute pression 2 voies boisseau sphérique BSP

Rubinetto a sfera femmina-femmina BSP



DN	THREAD ROSCA	Part nº Referencia	€
4	1/8" BSP	BKH G 1/8	42,58
6	1/4" BSP	BKH G 1/4	31,26
10	3/8" BSP	BKH G 3/8	29,05
13	1/2" BSP	BKH G 1/2	32,95
20	3/4" BSP	BKH G 3/4	67,69
25	1" BSP	BKH G 1	76,75
25	1"1/4 BSP	BKH G 1 1/4 DN25	82,23
25	1"1/2 BSP	BKH G 1 1/2 DN25	146,55

Orificios de fijación incluidos desde 1/8" BSP hasta 1" BSP / Fixation holes included from 1/8" BSP to 1" BSP / Trous de fixation inclus depuis 1/8" BSP jusqu'à 1" BSP / Fori di fissaggio inclusi da 1/8" BSP fino a 1" BSP

Llave 2 vías tubo rígido Serie Ligera

2 Ways ball valve: tube connection Light Series

Robinet haute pression 2 voies boisseau sphérique sortie pour tube rigide DIN Série Légère

Rubinetto a sfera maschio DIN 2353 Serie L



DN	PIPE TUBO	THREAD ROSCA	Part nº Referencia	€
4	6L	M12x1.5	BKH 6 L	39,78
6	8L	M14x1.5	BKH 8 L	30,46
8	10L	M16x1.5	BKH 10 L	31,66
10	12L	M18x1.5	BKH 12 L	36,24
13	15L	M22x1.5	BKH 15 L	35,80
16	18L	M26x1.5	BKH 18 L	47,88
20	22L	M30x2	BKH 22 L	79,61
25	28L	M36x2	BKH 28 L	127,61
25/32	35L	M45X2	BKH 35 L	133,60
25/40	42L	M52x2	BKH 42 L	215,72

Llave 2 vías tubo rígido Serie Pesada

2 Ways ball valve: tube connection Heavy Series

Robinet haute pression 2 voies boisseau sphérique sortie pour tube rigide din Série Lourde

Rubinetto a sfera maschio DIN Serie S



DN	PIPE TUBO	THREAD ROSCA	Part nº Referencia	€
4	8S	M16x1.5	BKH 8 S	44,16
6	10S	M18x1.5	BKH 10 S	36,97
8	12S	M20x1.5	BKH 12 S	33,75
10	14S	M22x1.5	BKH 14 S	48,73
13	16S	M24x1.5	BKH 16 S	42,03
16	20S	M30x2	BKH 20 S	94,18
13	20S	M30x2	BKH 20 S DN13	56,34
20	25S	M36x2	BKH 25 S	87,71
25	30S	M42x2	BKH 30 S	123,04

Llave 2 vías rosca hembra NPT

2 Ways ball valve NPT female

Robinet haute pression 2 voies boisseau sphérique sortie femelle briggs (NPT)

Rubinetto a sfera 2 vie femmina NPT



DN	THREAD ROSCA	Part nº Referencia	€
6	1/4" NPT	BKH G 1/4 NPT	47,57
10	3/8" NPT	BKH G 3/8 NPT	55,13
13	1/2" NPT	BKH G 1/2 NPT	59,63
20	3/4" NPT	BKH G 3/4 NPT	104,95
25	1" NPT	BKH G 1 NPT	135,59
25	1"1/4 NPT	BKH G 1 1/4 NPT	181,03
25	1"1/2 NPT	BKH G 1 1/2 NPT	237,79
50	2" NPT	BKH G 2 NPT	481,55

Llave 2 vías tubo rígido L paso total

Ball-valves: tube connection L serie DIN 2353 full bore

Robinetts haute pression 2 voies boisseau sphérique femelle ISO 228

Rubinetto a sfera maschio DIN 2353 -L-



DN	PIPE TUBO	THREAD ROSCA	Part nº Referencia	€
32	35L	M45X2	BKH 35 L DN32	325,75
40	40L	M52x2	BKH 42 L DN40	430,28

Llave 2 vías tubo rígido S paso total

Ball-valves: tube connection S serie DIN 2353 full bore

Robinetts haute pression 2 voies boisseau sphérique métrique Série Lourde passage total

Rubinetto a sfera maschio DIN 2353 -S-



DN	PIPE TUBO	THREAD ROSCA	Part nº Referencia	€
32	38S	M52x2	BKH 38 S DN32	330,51

Llave de paso BSP hembra ISO 228 paso total

Ball-valves BSP female ISO 228

Robinetts haute pression 2 voies boisseau sphérique femelle ISO 228

Rubinetto a sfera femmina BSP ISO228



DN	THREAD ROSCA	Part nº Referencia	€
32	1"1/4 BSP	BKH G 1 1/4 DN32	322,95
40	1"1/2 BSP	BKH G 1 1/2 DN40	373,81
50	2" BSP	BKH G 2 DN50	485,46

Llaves de paso alta presión

Ball valves high pressure
Robinetts haute pression
Rubinetti a sfera alta pressione

Llave 3 vías hembra-hembra-hembra BSP (Tipo L)

3 Ways ball valve BSP female-female-female (Type L)

Robinet haute pression 3 voies série "L" boisseau sphérique femelle-femelle-femelle BSP

Rubinetto a sfera 3 vie femmina (Tipo L)



DN	THREAD ROSCA	Part nº Referencia	€
6	1/4" BSP	BK3 G 1/4	76,20
10	3/8" BSP	BK3 G 3/8	76,20
13	1/2" BSP	BK3 G 1/2	88,87
20	3/4" BSP	BK3 G 3/4	174,98
25	1" BSP	BK3 G 1	240,26

La entrada del caudal es solamente por la vía central / The input flow is only through the central way / L'entrée du débit est seulement par la voie centrale / L'ingresso al flusso è solo la linea centrale

Llave 3 vías hembra multivía (Tipo L)

Multi-way ball valves female 3 ways (Type L)

Robinet haute pression 3 voies série "L" boisseau sphérique femelle gaz

Rubinetto a sfera 3 vie femmina (Tipo L)



DN	THREAD ROSCA	Part nº Referencia	€
4	1/8" BSP	3KH G 1/8	434,97
6	1/4" BSP	3KH G 1/4	337,63
10	3/8" BSP	3KH G 3/8	381,06
13	1/2" BSP	3KH G 1/2	489,85
20	3/4" BSP	3KH G 3/4	840,82
25	1" BSP	3KH G 1	880,35
25/32	1"1/4 BSP	3KH G 1 1/4	957,53
25/40	1"1/2 BSP	3KH G 1 1/2	984,09

La entrada del caudal puede ser por cualquiera de las 3 vías / The input flow can be done through any of the 3 ways / L'entrée du débit peut être par l'un des 3 voies / Il flusso in ingresso può essere da qualsiasi dei 3 vie

Llave 4 vías rosca hembra BSP (Tipo X)

Multi-way ball valves female 4 ways (Type X)

Robinet haute pression 4 voies série "X" boisseau sphérique femelle gaz

Rubinetto 4 vie femmina BSP (Tipo X)



DN	THREAD ROSCA	Part nº Referencia	€
4	1/8" BSP	4KH G 1/8	408,41
6	1/4" BSP	4KH G 1/4	471,46
10	3/8" BSP	4KH G 3/8	386,79
13	1/2" BSP	4KH G 1/2	460,49
20	3/4" BSP	4KH G 3/4	931,95
25	1" BSP	4KH G 1	968,49
25/32	1"1/4 BSP	4KH G 1 1/4	1.084,22
25/40	1"1/2 BSP	4KH G 1 1/2	1.139,04

Llave 3 vías hembra-hembra-hembra BSP (Tipo T)

3 Ways ball valve BSP female-female-female (Type T)

Robinet haute pression 3 voies série "T" boisseau sphérique femelle-femelle-femelle BSP

Rubinetto a sfera 3 vie femmina (Tipo T)



DN	THREAD ROSCA	Part nº Referencia	€
6	1/4" BSP	BK3 G 1/4 T	76,20
10	3/8" BSP	BK3 G 3/8 T	76,20
13	1/2" BSP	BK3 G 1/2 T	88,87
20	3/4" BSP	BK3 G 3/4 T	174,98
25	1" BSP	BK3 G 1 T	240,26

La entrada del caudal es solamente por la vía central / The input flow is only through the central way / L'entrée du débit est seulement par la voie centrale / L'ingresso al flusso è solo la linea centrale

Llave 3 vías hembra-hembra-hembra NPT (Tipo L)

3 Ways ball valve NPT female-female-female (Type L)

Robinet haute pression 3 voies série "L" boisseau sphérique femelle-femelle-femelle NPT

Rubinetto a sfera 3 vie NPT femmina (Tipo L)



DN	THREAD ROSCA	Part nº Referencia	€
6	1/4" NPT	BK3 1/4 NPT	110,62
6	3/8" NPT	BK3 3/8 NPT	115,50
6	1/2" NPT	BK3 1/2 NPT	94,87
6	3/4" NPT	BK3 3/4 NPT	192,04
6	1" NPT	BK3 1 NPT	264,68

Llaves especiales 3 vías macho-macho-macho (Tipo L)

Special 3 way valves male-male-male (Type L)

Robinetts spéciaux 3 voies série "L" mâle-mâle-mâle

Rubinetti speciali 3 vie maschio-maschio-maschio



THREAD ROSCA	DESCRIPTION DESCRIPCIÓN	Part nº Referencia	€
1/2" BSP	3 Ways	A60030810	266,10

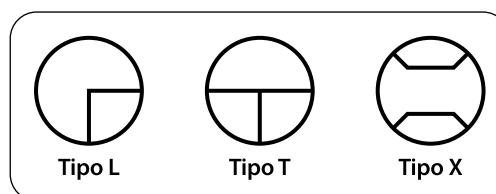

Llaves de paso alta presión

Ball valves high pressure
Robinets haute pression
Rubinetti a sfera alta pressione

Útil para cierre con candado tipo 2

Locking devices type 2

Dispositifs de verrouillage type 2

Dispositivo di bloccaggio tipo 2



DESCRIPTION DESCRIPCIÓN	Part nº Referencia	€
For ball valves: hex.9, DN4-8	CANDT2-9A	35,27
For ball valves: hex.9, DN10-13	CANDT2-9B	35,27
For ball valves: hex.14, DN20-25	CANDT2-14	60,97

Útil para cierre con candado tipo 4

Locking devices type 4

Dispositifs de verrouillage type 4

Dispositivo di bloccaggio tipo 4



DESCRIPTION DESCRIPCIÓN	Part nº Referencia	€
For ball valves: Hex.9	CANDT4-9	44,80
For ball valves: Hex.14	CANDT4-14	58,04

Manetas para llaves

Levers for ball valves

Leviers pour robinets

Manopole per rubinetti a sfera



SIZE TAMAÑO	Part nº Referencia	€
9	AR603722	6,38
9	C600063	9,14
9	A60013155330	11,69
12	L501741	15,23
14	A60013155331	11,21
14	C708618	14,01
14	LR606745	14,02
17	LR801799	30,00

Ver tabla de dimensiones en pág 336 / See dimension table in page 336 / Voir table de dimensions à la page 336 / Vedere tabella di dimensioni a pagina 336

Adaptors

Quick-release
couplings

Ball valves

Diverters

Swivel fittings

Multi-way couplings

Protections

Llaves de paso

Ball valves
Robinets
Rubinetti a sfera

Manetas 1
Handles for ball-valves
Leviers pour robinets
Maniglia

Manetas 2
Handles for ball-valves
Leviers pour robinets
Maniglia

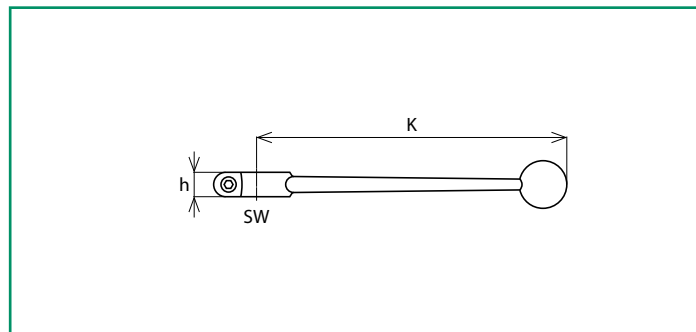
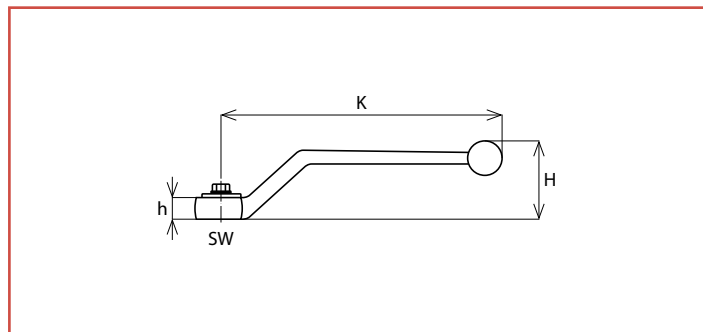

	SW	Zinc Zinc Zinco Zinc			Aluminio Aluminum Alluminio Aluminium			INOX/SS316L			Acero Steel Acier Acciaio		
Serie BSP 1/8 - 1/4 - 3/8 - 1/2 - 5/8	9	A60013155330* (1)			AR603722*			Z60013155330 *			C600063*		
Serie DIN 6 - 8 - 10 - 12 - 14 - 15 - 16		H	J	K	H	J	K	H	J	K	H	J	K
		45	8.7	155	-	10	155	45	8.7	155	47	9	155
Serie BSP 3/8	12				L501741* (1)								
Serie DIN 18		H	J	K	H	J	K	H	J	K	H	J	K
		55	12	160									
Serie BSP 3/4 - 1 - 1 1/4	14	A60013155331* (1)			LR606745 *			Z60013155331*			C708618*		
Serie DIN 22 - 25 - 28 - 30 - 35 - 38		H	J	K	H	J	K	H	J	K	H	J	K
		-	13	200	-	12	200	-	13	200	64	12	171
Serie BSP 1 1/4 - 1 1/2 - 2	17				LR801799* (1)			Z60013155332*					
Serie DIN 3 3-5 - 38 - 42		H	J	K	H	J	K	H	J	K	H	J	K
		-	16	320	-	15	90	-	15	90			

Las llaves se suministran con maneta de zinc o aluminio
Handles for ball-valves are supplied with zinc or aluminum
Leviers pour robinets fournis avec une poignée en zinc ou en aluminium
I rubinetti sono forniti con maniglia dincate o alluminio

(1) Maneta sumistrada junto a la llave / Handles are supplied for ball-valves / Leviers sont fournies pour robinets / I rubinetti sono fornite con maniglia

Llaves de paso baja presión

Low pressure Ball valves
Robinets Basse pression
Rubinetti Bassa pressione

Llave de esfera baja presión

2 Ways ball valve low pressure

Robinet basse pression 2 voies boisseau
sphérique pn 16/25



Rubinetti a sfera bassa pressione

PIPE TUBO	THREAD ROSCA	Part n° Referencia	€
10	1/4" BSP	BP2V14	8,97
10	3/8" BSP	BP2V38	8,97
15	1/2" BSP	BP2V12	7,33
20	3/4" BSP	BP2V34	10,34
25	1" BSP	BP2V1	16,89
32	1"1/4 BSP	BP2V114	25,62
40	1"1/2 BSP	BP2V112	37,68
50	2" BSP	BP2V2	55,08
74	3" BSP	BP2V3	190,79
92	4" BSP	BP2V4	321,61

Llave de esfera baja presión anti-hielo

2 Ways ball valve low pressure non frozen

Robinet basse pression 2 voies boisseau
sphérique pn 25 anti-gel



Rubinetti a sfera, anti-gelo

PIPE TUBO	THREAD ROSCA	Part n° Referencia	€
10	1/4" BSP	BP2VA14	6,43
10	3/8" BSP	BP2VA38	6,54
14,5	1/2" BSP	BP2VA12	10,29
19	3/4" BSP	BP2VA34	14,71
24	1" BSP	BP2VA1	22,66
30	1"1/4 BSP	BP2VA114	38,04
37	1"1/2 BSP	BP2VA112	54,10
47	2" BSP	BP2VA2	86,64
59	2"1/2 BSP	BP2VA212	158,01
70	3" BSP	BP2VA3	244,76
85,5	4" BSP	BP2VA4	362,21

Llaves de paso alta presión TrΔle

TrΔle Ball Valves

Robinets TrΔle haute pression

Rubinetti a sfera TrΔle

Llaves 2 vías hembra BSP con agujeros

2 Ways ball valve BSP female with holes

Robinet 2 voies boisseau sphérique BSP avec trous de fixation

Rubinetto a due vie con fori fissaggio



DN	THREAD ROSCA	Part nº Referencia	€
6	1/4" BSP	GB2V 1/4	22,62
10	3/8" BSP	GB2V 3/8	27,60
13	1/2" BSP	GB2V 1/2	30,63
20	3/4" BSP	GB2V 3/4	46,89
25	1" BSP	GB2V 1	64,87

Llaves 2 vías rosca hembra NPT

2 Ways ball valve NPT female

Robinet 2 voies boisseau sphérique sortie femelle briggs (NPT)

Rubinetto a sfera 2 vie femmina NPT



DN	THREAD ROSCA	Part nº Referencia	€
6	1/4" NPT	GB2V 1/4 NPT	22,62
10	3/8" NPT	GB2V 3/8 NPT	27,60
13	1/2" NPT	GB2V 1/2 NPT	30,63
20	3/4" NPT	GB2V 3/4 NPT	46,89
25	1" NPT	GB2V 1 NPT	64,87

Llaves paso 3 vías hembra-macho(60°)-hembra (tipo L)

3 Ways ball valve female-male(60°)-female (L type)

Robinet 3 voies femelle-mâle (60°)-femelle (type L)

Rubinetto a tre vie fem-maschio (60°)-fem (tipo L)



DN	THREAD ROSCA	Part nº Referencia	€
6	1/4" BSP	GB3V 1/4	30,09
10	3/8" BSP	GB3V 3/8	47,79
13	1/2" BSP	GB3V 1/2	55,57
20	3/4" BSP	GB3V 3/4	72,25
25	1" BSP	GB3V 1	97,67

Llaves 2 vías tubo rígido Serie Ligera

2 Ways ball valve: tube connection Light Serie

Robinet 2 voies boisseau sphérique sortie pour tube rigide DIN Série Légère

Rubinetto a sfera maschio DIN 2353 Serie L



DN	PIPE TUBO	THREAD ROSCA	Part nº Referencia	€
6	6L	M12x1.5	GB2V 6 L	22,62
6	8L	M14x1.5	GB2V 8 L	25,40
8	10L	M16x1.5	GB2V 10 L	24,74
10	12L	M18x1.5	GB2V 12 L	27,14
13	15L	M22x1.5	GB2V 15 L	28,98
13	18L	M26x1.5	GB2V 18 L	29,14
20	22L	M30x2	GB2V 22 L	58,22
25	28L	M36x2	GB2V 28 L	75,34

Llaves 2 vías tubo rígido Serie Pesada

2 Ways ball valve: tube connection Heavy Serie

Robinet 2 voies boisseau sphérique sortie pour tube rigide DIN Série Lourde

Rubinetto a sfera maschio DIN 2353 Serie S



DN	PIPE TUBO	THREAD ROSCA	Part nº Referencia	€
4	8S	M16x1.5	GB2V 8 S	30,14
6	10S	M18x1.5	GB2V 10 S	25,91
8	12S	M20x1.5	GB2V 12 S	25,71
13	16S	M24x1.5	GB2V 16 S	40,68
16	20S	M30x2	GB2V 20 S	48,76
20	25S	M36x2	GB2V 25 S	65,06
25	30S	M42x2	GB2V 30 S	75,34

Llaves paso 3 vías hembra-hembra-hembra (tipo L)

3 Ways ball valve female-female-female (L type)

Robinet 3 voies femelle-femelle-femelle (type L)

Rubinetto a tre vie fem.-fem.-fem. (tipo L)



DN	THREAD ROSCA	Part nº Referencia	€
6	1/4" BSP	GB3VH 1/4	34,66
10	3/8" BSP	GB3VH 3/8	47,79
13	1/2" BSP	GB3VH 1/2	55,57
20	3/4" BSP	GB3VH 3/4	72,25
25	1" BSP	GB3VH 1	97,67



Química EPDM/ Chemical EPDM

Química UPE/ Chemical UPE

Soldadura Acetileno / Welding hose acetylene

Soldadura Oxígeno/ Welding oxygene

Limpieza Vapor / Steam cleaning

Alimentaria Polivalente /Multi- function food

Limpieza Industria Alimentaria/ Food industry cleaning

Transporte de Lácteos/ Dairy Transport

Polivalente multiservicio/ Multi-function

Impulsión de Hidrocarburos/ Hydrocarbons delivery

Impulsión de Mortero / Mortar delivery

Chorro de Abrasivos/ Sandblast

Aspiración Abrasiva /Abrasive suction

Aspiración Agua/ Water suction

Bebidas FDA/ FDA Beverage

Hidrocarburos/ Hydrocarbons



DICSA

GROWING UP TOGETHER



Camlock

Guillemin

Tw

Storz

Barcelona

Geka

Mortero Camlock

INDUSTRIAL

FITTINGS

Express

EA

Chorro Arena/ Sandblast

Vapor Boss/ Steam Boss

Abrazaderas /Clamps

Perrot / Bauer

Campanas/ Ferrules



Desviadores

Diverters

Déviateurs

Deviatori di flusso

Desviadores manuales

Diverters manual

Déviateurs manuels

Deviatori di flusso manuali

343

4

Desviadores manuales

Diverters manual
Déviateurs manuels
Deviatori di flusso manuali

- De 3 vías / 3 Way / 3 voies / 3 vie

| 343



D3V



D3VAP



D3V...CC

- De 4 vías / 4 Way / 4 voies / 4 vie

| 343



D4V

- De 6 vías / 6 Way / 6 voies / 6 vie

| 343



D6V



D6VAP

Desviadores manuales

Diverters manual
Déviateurs manuels
Deviatori di flusso manuali

Adaptors

Quick-release couplings

Ball valves

Diverters

Swivel fittings

Multi-way couplings

Protections

Desviador de 3 vías rosca hembra BSP

3 Way diverter BSP female

Déviateur manuel 3 voies femelle BSP

Deviatore di flusso 3 vie femmina



THREAD ROSCA	Part nº Referencia	€
1/4" BSP	D3V14	60,03
3/8" BSP	D3V38	53,87
1/2" BSP	D3V12	64,31
3/4" BSP	D3V34	75,31
1" BSP	D3V10	110,40
1 1/2" BSP	D3V112	343,00

Desviador 3 vías alta presión (400 bar)

High pressure 3 way flow diverter (400 bar)

Déviateur manuel 3 voies haute pression (400 bar)

Deviatore di flusso 3 vie alta pressione (400 bar)



DN	Part nº Referencia	€
3/8" BSP	D3VAP38	69,26
1/2" BSP	D3VAP12	69,26
3/4" BSP	D3VAP34	91,25

Desviador de 3 vías centros cerrados

3 Way closed centers diverter

Déviateur manuel 3 voies centres fermés

Deviatore di flusso 3 vie femmina centri chiusi



THREAD ROSCA	MAX. FLOW (l/min) CAUDAL MÁX.	Part nº Referencia	€
1/2" BSP	90	D3V12CC	72,67
3/4" BSP	120	D3V34CC	82,11
3/8" BSP	60	D3V38CC	60,03

Desviador de 4 vías

4 Way diverter BSP female

Déviateur manuel 4 voies femelle BSP

Deviatore di flusso 4 vie femmina



THREAD ROSCA	Part nº Referencia	€
1/4" BSP	D4V14	75,46
3/4" BSP	D4V34	115,76
1/2" BSP	D4V12	92,18
3/8" BSP	D4V38	75,46

Desviador de 6 vías

6 Way diverter BSP female

Déviateur manuel 6 voies femelle BSP

Deviatore di flusso 6 vie femmina



THREAD ROSCA	Part nº Referencia	€
1/4" BSP	D6V14	131,84
3/8" BSP	D6V38	120,38
1/2" BSP	D6V12	159,71
3/4" BSP	D6V34	177,93

Desviador 6 vías alta presión (400 bar)

High pressure 6 way flow diverter (400 bar)

Déviateur manuel 6 voies haute pression (400 bar)

Deviatore di flusso 6 vie alta pressione (400 bar)



DN	Part nº Referencia	€
3/8" BSP	D6VAP38	111,03
1/2" BSP	D6VAP12	111,03
3/4" BSP	D6VAP34	153,91

Racores giratorios

Swivel fittings

Raccords tournants

Raccordi girevoli

Racores giratorios Serie Italiana

Swivel fittings Italian series

Raccords tournants série Italienne

Raccordi girevoli serie italiana

347

Racores giratorios Serie TrΔle

TrΔle series Swivel fittings

Raccords tournants série TrΔle

Raccordi girevoli TrΔle

348

5

Racores giratorios Serie Italiana

Swivel fittings Italian series
Raccords tournants série Italienne
Raccordi girevoli serie italiana

■ BSP / BSP / BSP / BSP

| 347



GGL

GG90

■ NPT / NPT / NPT / NPT

| 347



GGL...NPT

GG90...NPT

Racores giratorios Serie TrΔle

TrΔle series Swivel fittings
Raccords tournants série TrΔle
Raccordi girevoli TrΔle

■ BSP / BSP / BSP / BSP

| 348



RGR

RG90

Racores giratorios Serie Italiana

Swivel fittings Italian series

Raccords tournants série Italienne

Raccordi girevoli serie italiana

Racor giratorio recto BSP

Straight swivel fittings BSP

Raccord tournant droit BSP



Giunto girevole BSP

THREAD ROSCA	Part n° Referencia	€
1/4" BSP	GGL 1/4	23,83
3/8" BSP	GGL 3/8	25,57
1/2" BSP	GGL 1/2	29,83
3/4" BSP	GGL 3/4	50,55
1" BSP	GGL 1	64,45
1"1/4 BSP	GGL 1 1/4	105,13
1"1/2 BSP	GGL 1 1/2	160,06
2" BSP	GGL 2	259,99

Racor giratorio 90° BSP

Elbow 90° swivel fitting BSP

Raccord tournant coude 90° BSP



Giunto girevole a 90° BSP

THREAD ROSCA	Part n° Referencia	€
1/4" BSP	GG90 1/4	26,76
3/8" BSP	GG90 3/8	29,79
1/2" BSP	GG90 1/2	35,72
3/4" BSP	GG90 3/4	62,70
1" BSP	GG90 1	81,54
1"1/4 BSP	GG90 1 1/4	160,37
1"1/2 BSP	GG90 1 1/2	244,30
2" BSP	GG90 2	342,85

Racor giratorio recto NPT

Straight swivel fittings NPT

Raccord tournant droit NPT



Giunto girevole NPT

THREAD ROSCA	Part n° Referencia	€
1/4" NPT	GGL 1/4 NPT	26,21
3/8" NPT	GGL 3/8 NPT	28,11
1/2" NPT	GGL 1/2 NPT	32,74
3/4" NPT	GGL 3/4 NPT	57,58
1" NPT	GGL 1 NPT	70,91

Racor giratorio 90° NPT

Elbow 90° swivel fitting NPT

Raccord tournant coude 90° NPT



Giunto girevole a 90° NPT

THREAD ROSCA	Part n° Referencia	€
1/4" NPT	GG90 1/4 NPT	29,41
3/8" NPT	GG90 3/8 NPT	32,72
1/2" NPT	GG90 1/2 NPT	39,25
3/4" NPT	GG90 3/4 NPT	72,81
1" NPT	GG90 1 NPT	89,73

Adaptors

Quick-release
couplings

Ball valves

Diversers

Swivel fittings

Multi-way couplings

Protections

Racores giratorios Serie TrΔle

TrΔle series Swivel fittings

Raccords tournants série TrΔle

Raccordi girevoli TrΔle

Racores giratorios rectos BSP

Straight swivel fitting BSP

Raccord tournant droit BSP

Raccordo girevole BSP



THREAD ROSCA	Part n° Referencia	€
1/4" BSP	RGR 1/4	15,61
3/8" BSP	RGR 3/8	22,77
1/2" BSP	RGR 1/2	26,06
3/4" BSP	RGR 3/4	38,38
1" BSP	RGR 1	54,70

Racores giratorios 90° BSP

Elbow 90° swivel fitting BSP

Raccord tournant coude 90° BSP

Raccordo girevole a 90° BSP



THREAD ROSCA	Part n° Referencia	€
1/4" BSP	RG90 1/4	17,54
3/8" BSP	RG90 3/8	27,07
1/2" BSP	RG90 1/2	36,45
3/4" BSP	RG90 3/4	46,33
1" BSP	RG90 1	67,66



ÁREA CALIDAD QUALITY DEPARTMENT



Cortadora de precisión
Precision cutting Saw



Abrasímetro
Abrasive meter



Banco de prueba Bimal B1703 Flex
B1703 FLEX Dynamic Test Bench



Banco de pruebas BC/L 2000
BC/L 2000 Test Bench

CENTRADOS EN LA CALIDAD

Garantizamos la calidad de todos los equipamientos que fabricamos y distribuimos. Por ello, estamos realizando, de forma progresiva y continuada, una gran inversión en la aprobación de certificados.

Nuestro Departamento Técnico y de Calidad comprueba la calidad óptima de los productos que suministramos, mediante la utilización de los equipamientos y la tecnología más innovadora del sector.

DICSA es sinónimo de calidad porque nuestra apuesta en Investigación, Desarrollo e Innovación es constante y progresiva. En Dicsa somos líderes porque fabricamos pensando en ti.

WE FOCUS ON QUALITY

We guarantee the quality of all the equipment that we manufacture and distribute. For this reason, we are making an ongoing and progressive investment in certificates approval.

Our Technical and Quality Department verifies the optimum quality of our products by using the most innovative equipments and technology.

DICSA is synonym of quality because our Research, Innovation and Development investment are constant and progressive. As a benchmark, DICSA proceeds our manufacture always keeping you in mind.



Análisis espectrográfico
Spectrographic Analyzer



Cámara de niebla salina
Salt-spray chamber



Banco de prueba Bimal BI1001
Bimal BI1001 Test Bench



Banco de pruebas BE 2500 II
BE 2500 II Test Bench

Multienchufes

Multi-way couplings

Multi-coupleur

Multinnesti rapidi

Multienchufe Serie TrΔle

TrΔle Multi-way coupling

Multi-coupleur TrΔle

Multinesti TrΔle

353

6

Multienchufe Serie TrΔle

TrΔle Multi-way coupling
 Multi-coupleur TrΔle
 Multinesti TrΔle

- Multienchufe 4 vías diseño DICSA / Multi-way coupling 4 ways - DICSA design / Multi-coupleur 4 voies - design DICSA / Multinesti a 4 linee - design DICSA | 353



MEDD44



MEDD_4

- Multienchufe 2 vías diseño DICSA / Multi-way coupling 2 ways - DICSA design / Multi-coupleur 2 voies - design DICSA / Multinesti a 2 linee - design DICSA | 353



MEDD22



MEDD_2

- Componentes multienchufe 2 vías/4 vías diseño DICSA / Parts Multi-way coupling 2/4 ways - DICSA design / Pièces multi-coupleur 2/ 4 voies - design DICSA / Elementi per multi innesti a 2 e 4 vie | 353



A930 / A940



MEDD

Multienchufe Serie TrΔle

TrΔle Multi-way coupling
Multi-coupleur TrΔle
Multinesti TrΔle

Multienchufe 4 vías con enchufes

Multi-way couplings 4 ways with couplings

Multi-coupleur 4 voies avec connecteur

Piastra multi-innesti a 4 linee, con innesti



C. E.	WAYS NR. Nº VIAS	Part nº Referencia	€
4 x F 1/2" BSP	4	MEDD44H08	659,78

Partes multienchufe 4 vías

Multi-way couplings 4 ways parts

Éléments Multi-coupleur 4 voies

Elementi multi-innesti a 4 linee



C. E.	WAYS NR. Nº VIAS	Part nº Referencia	€
---	4	MEDD4S	363,30
4 X F 1/2" BSP	4	MEDDH44H08	379,79
4 X F 1/2" BSP	4	MEDDM44H08	435,12

Multienchufe 2 vías con enchufes

Multi-way couplings 2 ways with couplings

Multi-coupleur 2 voies avec connecteur

Piastra multi-innesti a 2 linee, con innesti



C. E.	WAYS NR. Nº VIAS	Part nº Referencia	€
2 x F 1/2" BSP	2	MEDD22H08	420,56

Partes multienchufe 2 vías

Multi-way couplings 2 ways parts

Éléments Multi-coupleur 2 voies

Elementi multi-innesti a 2 linee



C. E.	WAYS NR. Nº VIAS	Part nº Referencia	€
---	2	MEDD2S	303,36
2 X F 1/2" BSP	2	MEDDH22H08	192,44
2 X F 1/2" BSP	2	MEDDM22H08	288,04

Enchufes rápidos

Quick-release couplings

Coupleurs rapides

Innesti rapidi



THREAD ROSCA	ISO SIZE TAMAÑO ISO	BG SIZE TAMAÑO BG	C. E.	Part nº Referencia	€
F 1/2" BSP	10	2	M	A930108	47,22
F 1/2" BSP	10	2	F	A930208	47,22

Componentes y repuestos

Spare parts

Pièces Détachées

Ricambi



C. E.	Part nº Referencia	€
MEDD2, MEDD4	SETA MEDD	13,54
MEDD2	MEDD1802	91,32
MEDD4	MEDD1804	128,09

MULTI - 2



MULTI - 4

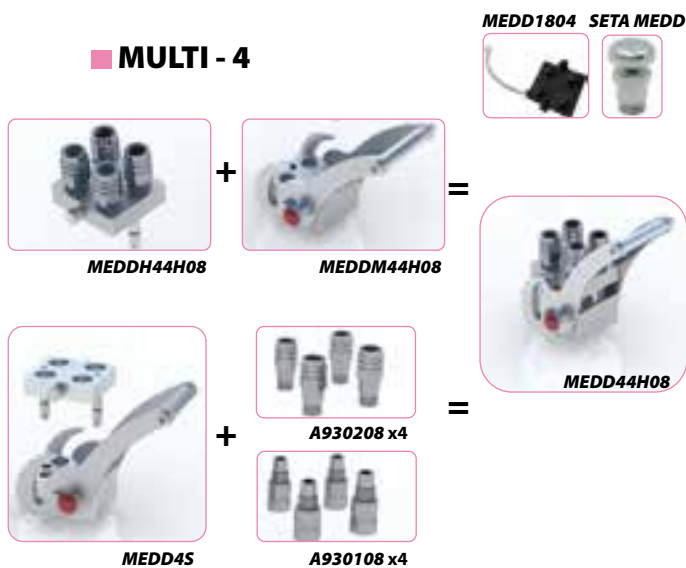

Protecciones

Protections

Protections

Protezioni

Tapones de plástico

Plastic plugs

Capuchons plastique

Tappi di plastica

359

Muelles

Springs

Ressorts

Spirali

362

Protecciones textiles

Protections

Protection textile

Protezioni tessili

364

Fijaciones de seguridad

Safety fixation

Système de sécurité anti-fouet

Fune di sicurezza

367

7

Tapones de plástico

Plastic plugs
 Capuchons plastique
 Tappi di plastica

- Tapones hembra para roscas macho / Female plugs for male thread / Capuchons plastique femelle pour filetage mâle / Tappi femmina per filettature maschio | 359



TFG

TFM

TFU

- Tapones para bridas / Plugs for flanges / Capuchons plastique de brides SAE / Tappi per flangia | 359



TS 3000

TS 6000

- Tapones macho para roscas hembra / Male plugs for female thread / Bouchons plastique mâle pour filetage femelle / Tappi maschio per filettature femmina | 360



TMG

TMM

TMU

- Cinta PTFE / PTFE Tape / Ruban PTFE / Nastro di PTFE | 360



M29990

- Tapones para latiguillos / Plugs for hoses / Capuchons pour tuyau / Tappi per tubi | 361



LHT

Muelles

Springs
Ressorts
Spirali

- Muelles de plástico / Plastic springs / Ressorts plastique / Spirali di plastica

| 362



AMUELLE P

AMUELLE PR

AMUELLE HDPE

AMUELLE HDPEY

- Muelles metálicos / Metallic springs / Ressorts métalliques / Spirali metallica

| 363



AMUELLE

Protecciones textiles

Protections
Protection textile
Protezioni tessili

- Protección fibra de vidrio y cerámica / Fiberglass protection / Protection en fibre de verre / Protezione in fibra di vetro | 364



- Protección textil / Protections / Protection textile / Protezioni tessile | 366



Fijaciones de seguridad

Safety fixation
Système de sécurité anti-fouet
Fune di sicurezza

- Elementos de fijación de seguridad / Safety fixation elements / Système de sécurité anti-fouet / Componenti per fune di sicurezza | 367



Tapones de plástico

Plastic plugs
Capuchons plastique
Tappi di plastica

Tapón plástico hembra rosca BSP

Plastic female cap - BSP thread

Bouchons plastique femelle - gaz

Tappo plastica femmina BSP



THREAD ROSCA	UNITS PER BAG CANTIDAD / BOLSA	Part nº Referencia	€
1/8" BSP	100	TFG 1/8	0,15
1/4" BSP	100	TFG 1/4	0,16
3/8" BSP	100	TFG 3/8	0,19
1/2" BSP	100	TFG 1/2	0,18
5/8" BSP	100	TFG 5/8	0,28
3/4" BSP	100	TFG 3/4	0,21
1" BSP	100	TFG 1	0,30
1"1/4 BSP	100	TFG 1 1/4	0,45
1"1/2 BSP	100	TFG 1 1/2	0,48
2" BSP	50	TFG 2	0,71

Tapón plástico hembra rosca Métrica

Plastic female cap - Metric thread

Bouchons plastique femelle Métriques

Tappo plastica femmina Metrico



THREAD ROSCA	UNITS PER BAG CANTIDAD / BOLSA	Part nº Referencia	€
M12x1.5	100	TFM 12X1.5	0,18
M14x1.5	100	TFM 14X1.5	0,17
M16x1.5	100	TFM 16X1.5	0,21
M18x1.5	100	TFM 18X1.5	0,20
M20x1.5	100	TFM 20X1.5	0,20
M22x1.5	100	TFM 22X1.5	0,20
M24x1.5	100	TFM 24X1.5	0,25
M26x1.5	100	TFM 26X1.5	0,22
M30x2	100	TFM 30X2	0,26
M36x2	100	TFM 36X2	0,32
M42x2	100	TFM 42X2	0,36
M52x2	50	TFM 52X2	0,74

Tapón plástico hembra rosca UNF/JIC

Plastic female cap - UNF (JIC) thread

Bouchons plastique femelle - JIC-UNF

Tappo plastica femmina UNF/JIC



THREAD ROSCA	UNITS PER BAG CANTIDAD / BOLSA	Part nº Referencia	€
7/16" UNF	100	TFU 7/16	0,19
1/2" UNF	100	TFU 1/2	0,18
9/16" UNF	100	TFU 9/16	0,18
3/4" UNF	100	TFU 3/4	0,19
7/8" UNF	100	TFU 7/8	0,20
1"1/16 UNF	100	TFU 1 1/16	0,23
1"5/16 UNF	100	TFU 1 5/16	0,31
1"5/8 UNF	100	TFU 1 5/8	0,36
1"7/8 UNF	100	TFU 1 7/8	0,40

Tapón plástico para bridas 3000 PSI

Plastic caps for SAE 3000 PSI flanges

Bouchons plastique de brides SAE 3000 PSI

Tappo de plastica per flangia SAE 3000 PSI



DN	SERIE	SIZE TAMAÑO	UNITS PER BAG CANTIDAD / BOLSA	Part nº Referencia	€
30,2	3000 PSI	1/2"	100	TS 3000 1/2	0,30
38,1	3000 PSI	3/4"	100	TS 3000 3/4	0,27
44,5	3000 PSI	1"	100	TS 3000 1	0,32
50,8	3000 PSI	1"1/4	100	TS 3000 1 1/4	0,35
60,3	3000 PSI	1"1/2	100	TS 3000 1 1/2	0,39
71,4	3000 PSI	2"	100	TS 3000 2	0,44

Tapón plástico para bridas 6000 PSI

Plastic caps for SAE 6000 PSI flanges

Bouchons plastique de brides SAE 6000 PSI

Tappo de plastica per flangia SAE 6000 PSI



DN	SERIE	SIZE TAMAÑO	UNITS PER BAG CANTIDAD / BOLSA	Part nº Referencia	€
31,8	6000 PSI	1/2"	100	TS 6000 1/2	0,32
41,3	6000 PSI	3/4"	100	TS 6000 3/4	0,31
47,6	6000 PSI	1"	100	TS 6000 1	0,41
54	6000 PSI	1"1/4	100	TS 6000 1 1/4	0,42
63,5	6000 PSI	1"1/2	100	TS 6000 1 1/2	0,48
79,4	6000 PSI	2"	50	TS 6000 2	0,70

Tapones de plástico

Plastic plugs
Capuchons plastique
Tappi di plastica

Tapón plástico macho rosca BSP

Plastic male plug for BSP thread

Bouchons plastique mâle - BSP

Tappo plastica maschio BSP



THREAD ROSCA	UNITS PER BAG CANTIDAD / BOLSA	Part nº Referencia	€
1/8" BSP	100	TMG 1/8	0,17
1/4" BSP	100	TMG 1/4	0,16
3/8" BSP	100	TMG 3/8	0,18
1/2" BSP	100	TMG 1/2	0,22
5/8" BSP	100	TMG 5/8	0,23
3/4" BSP	100	TMG 3/4	0,25
1" BSP	100	TMG 1	0,35
1 1/4" BSP	100	TMG 1 1/4	0,50
1 1/2" BSP	50	TMG 1 1/2	0,88
2" BSP	50	TMG 2	0,90

Tapón plástico macho rosca Métrica

Plastic male plug for Metric thread

Bouchons plastique mâle - Métriques

Tappo plastica maschio Metrico



THREAD ROSCA	UNITS PER BAG CANTIDAD / BOLSA	Part nº Referencia	€
M12x1.5	100	TMM 12X1.5	0,16
M14x1.5	100	TMM 14X1.5	0,17
M16x1.5	100	TMM 16X1.5	0,18
M18x1.5	100	TMM 18X1.5	0,23
M20x1.5	100	TMM 20X1.5	0,22
M22x1.5	100	TMM 22X1.5	0,22
M24x1.5	100	TMM 24X1.5	0,24
M26x1.5	100	TMM 26X1.5	0,26
M30x2	100	TMM 30X2	0,29
M36x2	100	TMM 36X2	0,40
M42x2	50	TMM 42X2	0,62
M45x2	50	TMM 45X2	0,77
M52X2	50	TMM 52X2	0,95

Tapón plástico macho rosca UNF/JIC

Plastic male plug for UNF (JIC) thread

Bouchons plastique mâle - JIC-UNF

Tappo plastica maschio UNF/JIC



THREAD ROSCA	UNITS PER BAG CANTIDAD / BOLSA	Part nº Referencia	€
7/16" UNF	100	TMU 7/16	0,20
1/2" UNF	100	TMU 1/2	0,18
9/16" UNF	100	TMU 9/16	0,17
3/4" UNF	100	TMU 3/4	0,21
7/8" UNF	100	TMU 7/8	0,22
1" 1/16 UNF	100	TMU 1 1/16	0,26
1" 5/16 UNF	100	TMU 1 5/16	0,35
1" 5/8 UNF	50	TMU 1 5/8	0,63
1" 7/8 UNF	50	TMU 1 7/8	0,76

Cinta PTFE

PTFE Tape

Ruban PTFE

Nastro di PTFE



DESCRIPTION DESCRIPCIÓN	Part nº Referencia	€
1 roll	M299900	1,18
10 rolls	M2999010	12,98
200 rolls	M29990200	260,00

Tapones de plástico

Plastic plugs
Capuchons plastique
Tappi di plastica

Tapones para latiguillos

Caps for assemblies

Capuchons pour tuyau

Tappi per tubi



SIZE TAMAÑO	UNITS PER BAG CANTIDAD / BOLSA	Part nº Referencia	€
HEX14	100	LHT014	0,26
HEX16	100	LHT016	0,27
HEX17	100	LHT017	0,28
HEX19	100	LHT019	0,30
HEX22	100	LHT022	0,32
HEX24	100	LHT024	0,37
HEX25	100	LHT025	0,38
HEX27	100	LHT027	0,39
HEX30	100	LHT030	0,57
HEX32	100	LHT032	0,62
HEX36	100	LHT036	0,64
HEX41	50	LHT041	0,85
HEX46	50	LHT046	1,15
HEX50	50	LHT050	1,27
HEX55	50	LHT055	1,73
HEX60	25	LHT060	2,52
HEX65	25	LHT065	3,04
HEX70	25	LHT070	3,06
HEX75	25	LHT075	3,06
HEX80	25	LHT080	3,16



REDUCTION OF CODES
VALID FOR MULTIPLE CONNECTIONS
PRODUCTION INCREASE
EASY ASSEMBLY
GREATER PROTECTION

REDUCCIÓN DE CÓDIGOS
VÁLIDO PARA MÚLTIPLES CONEXIONES
AUMENTO DE LA PRODUCCIÓN
FÁCIL COLOCACIÓN
MAYOR PROTECCIÓN



Muelles

Springs
Ressorts
Spirali

Muelle de plástico plano

Flat plastic spring

Ressort plastique plat



Spirale di plastica piatta

DN	LENGTH (M) LONGITUD (M)	Thickness (mm) Espesor (mm)	SPIRAL PITCH PASO ESPIRAL	Part n° Referencia	€
12	50	1	8	AMUELLE P12	4,38
13	50	1	16	AMUELLE P13	4,98
15	50	1	16	AMUELLE P15	5,09
16	50	1	16	AMUELLE P16	5,14
17	50	1	16	AMUELLE P17	5,19
18	50	1	16	AMUELLE P18	5,30
20	50	1	16	AMUELLE P20	5,36
21	50	1	16	AMUELLE P21	5,52
22	50	1	16	AMUELLE P22	5,57
25	50	1	16	AMUELLE P25	6,38
28	50	1	16	AMUELLE P28	7,20
30	50	1	16	AMUELLE P30	7,41
33	20	2	16	AMUELLE P33	11,47
35	20	2	16	AMUELLE P35	11,69
38	20	2	16	AMUELLE P38	12,01
40	20	2	16	AMUELLE P40	12,23
45	20	2	16	AMUELLE P45	13,85
48	20	2	16	AMUELLE P48	14,39
50	20	2	16	AMUELLE P50	14,88
55	20	2	16	AMUELLE P55	17,58
60	20	2	16	AMUELLE P60	19,64
70	20	2	16	AMUELLE P70	23,97
80	15	2	16	AMUELLE P80	27,65

Muelle de plástico redondo

Round plastic spring

Ressort plastique rond



Spirale di plastica rotonda

DN	LENGTH (M) LONGITUD (M)	Thickness (mm) Espesor (mm)	SPIRAL PITCH PASO ESPIRAL	Part n° Referencia	€
12 - 16	50	1.5	12	AMUELLE PR12	1,55
16 - 20	50	2	16	AMUELLE PR16	2,65
20 - 25	50	2.5	18	AMUELLE PR20	3,69
25 - 30	50	2.5	23	AMUELLE PR25	5,75

AMUELLE

L = PASO ESPIRAL / SPIRAL PITCH
e = ESPESOR / THICKNESS

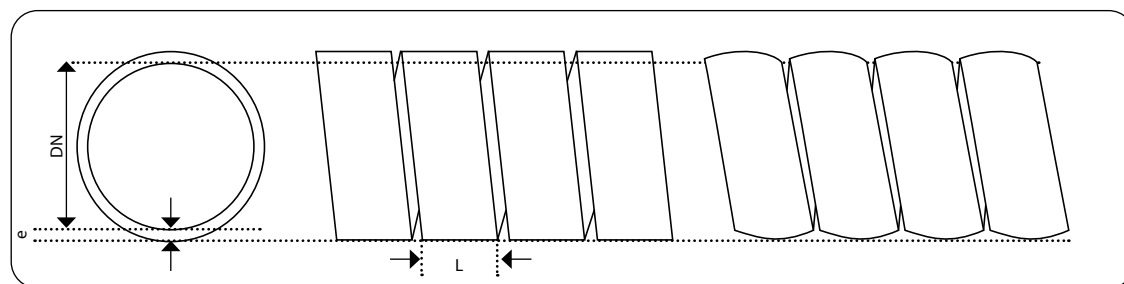

Muelle plano PEAD, color negro

HDPE flat spring, black color

Ressort plat en HDPE, couleur noir



Spirale in HDPE, colore nero

DN	Ø OUTER Ø EXT.	LENGTH (M) LONGITUD (M)	Thickness (mm) Espesor (mm)	SPIRAL PITCH PASO ESPIRAL	Part n° Referencia	€
13	16	25	1.3	13	AMUELLE HDPE13	4,00
16	20	25	2	13	AMUELLE HDPE16	4,65
20	25	25	2.2	20	AMUELLE HDPE20	5,13
27	32	25	2.5	24	AMUELLE HDPE27	6,38
35	40	25	2.7	24	AMUELLE HDPE35	9,67
43	50	25	3.4	30	AMUELLE HDPE43	11,94
56	63	25	3.7	37	AMUELLE HDPE56	16,15
66	75	20	4.4	42	AMUELLE HDPE66	19,55

Muelle plano PEAD, color amarillo

HDPE flat spring, yellow color

Ressort plat en HDPE, couleur jaune



Spirale in HDPE, colore giallo

DN	LENGTH (M) LONGITUD (M)	Thickness (mm) Espesor (mm)	SPIRAL PITCH PASO ESPIRAL	Part n° Referencia	€
13	25	1.3	13	AMUELLE HDPEY13	4,16
16	25	2	13	AMUELLE HDPEY16	4,84
20	25	2.2	20	AMUELLE HDPEY20	5,40
27	25	2.5	24	AMUELLE HDPEY27	6,75
35	25	2.7	24	AMUELLE HDPEY35	10,13
43	25	3.4	30	AMUELLE HDPEY43	12,55
56	25	3.7	37	AMUELLE HDPEY56	16,94
66	20	4.4	42	AMUELLE HDPEY66	20,54

Muelles

Springs
Ressorts
Spirali

Muelle metálico plano perfil 5x1

Flat metallic spring 5x1

Ressort métallique plat profil 5x1

Spirali in metallo piatta 5x1



DN	LENGTH (M) LONGITUD (M)	Part nº Referencia	€
16	4	AMUELLE16	10,59
18	4	AMUELLE18	10,70
20	4	AMUELLE20	10,76
22	4	AMUELLE22	11,42
24	4	AMUELLE24	12,08
26	4	AMUELLE26	12,63
28	4	AMUELLE28	14,45
30	4	AMUELLE30	14,89
32	4	AMUELLE32	15,39
34	4	AMUELLE34	15,83
38	4	AMUELLE38	16,77
40	4	AMUELLE40	17,43
42	4	AMUELLE42	18,64
47	4	AMUELLE47	20,08
52	2	AMUELLE52	20,85
60	2	AMUELLE60	23,55
68	1	AMUELLE68	28,96
72	1	AMUELLE72	30,34

Podemos suministrar muelles metálicos redondos en acero galvanizado bajo plano. Consúltenos

We can supply rounded metallic springs in galvanized steel under drawing. Please, enquire us

Nous pouvons fournir des ressorts métalliques ronds en acier galvanisé sur plan. Consultez-nous

Possiamo fornire spirali metalliche in filo tondo di acciaio galvanizzato su richiesta.

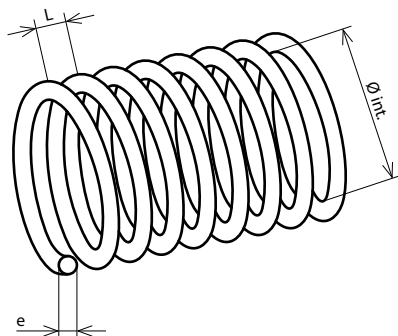

Datos necesarios para consultar:

Necessary data to enquire:

Données nécessaires pour consulter:

Dati necessari per l'ordine:

L = espacio entre alambres / space between wires / espace entre fils de fer / spazio tra

e = espesor alambre / wire thickness / épaisseur / spessore

Ø = Ø interior del muelle / Ø int. wire / Ø int. / interno della molla

Longitud del muelle / Spring length / Longueur du ressort / Longhezza della molla

Protecciones textiles

Protections
Protection textile
Protezioni tessili

Tubo de fibra de vidrio

Fibreglass tube

Gaine de fibre de verre

Tubo di fibra di vetro



Ø Inner Min. Ø INT. MIN.	Ø Inner Max. Ø INT. MAX.	DIAMETER (mm) DIAMETRO (mm)	Part n° Referencia	€
12	15	15	AVIDRIO 15	3,31
16	18	20	AVIDRIO 20	4,42
18	22	25	AVIDRIO 25	5,53
25	28	30	AVIDRIO 30	6,68
28	32	35	AVIDRIO 35	8,10
30	35	40	AVIDRIO 40	8,84
38	42	45	AVIDRIO 45	10,31
45	48	50	AVIDRIO 50	11,05
48	52	60	AVIDRIO 60	16,20
70	72	75	AVIDRIO 75	20,62

Jitrakor cinta adhesiva

Jitrakor adhesive tape

Jitrakor bande adhesive

Jitrakor striscia adesiva



LENGTH (M) LONGITUD (M)	Part n° Referencia	€
10	JITRAKOR	31,11

€/rollo / €/roll / €/rouleau / €/rotolo

Tubo de fibra de vidrio siliconado

Silicone fibreglass tube

Gaine de fibre de verre siliconée

Tubo di fibra di vetro siliconato



DN	Part n° Referencia	€
12	AVIDRIO S 12	16,93
16	AVIDRIO S 16	18,69
19	AVIDRIO S 19	21,49
25	AVIDRIO S 25	28,85
28	AVIDRIO S 28	32,56
32	AVIDRIO S 32	34,91
38	AVIDRIO S 38	36,08
51	AVIDRIO S 51	54,77
70	AVIDRIO S 70	108,43

Tubo de fibra de vidrio siliconado serie B

B Series silicone fibreglass tube

Gaine de fibre de verre siliconée Série B

Tubo di fibra di vetro siliconato Serie B



DN	Part n° Referencia	€
12	BVIDRIO S 12	11,40
15	BVIDRIO S 16	13,71
19	BVIDRIO S 19	15,78
22	BVIDRIO S 22	18,49
25	BVIDRIO S 25	21,20
30	BVIDRIO S 28	25,26
32	BVIDRIO S 32	29,09

Tubo de fibra cerámica

Ceramic fibre tube

Gaine de fibre de céramique

Tubo in fibra di ceramica



DN	Part n° Referencia	€
15	ACERAMICA 15	8,72
20	ACERAMICA 20	10,48
25	ACERAMICA 25	11,45
30	ACERAMICA 30	16,44
40	ACERAMICA 40	21,79
50	ACERAMICA 50	27,18
60	ACERAMICA 60	32,66
70	ACERAMICA 70	40,78

Tubo de fibra de vidrio saturada

Saturated fibreglass tube

Gaine de fibre de verre saturée

Tubo in fibra di vetro saturato



Ø Inner Min. Ø INT. MIN.	Ø Inner Max. Ø INT. MAX.	Part n° Referencia	€
1/2"	3/4"	AVIDRIO FA 08	10,88
5/8"	1"	AVIDRIO FA 10	14,72
3/4"	1" 1/4	AVIDRIO FA 12	19,60
1"	1" 3/4	AVIDRIO FA 16	29,17
1" 1/2	2" 1/4	AVIDRIO FA 24	44,93
2" 1/2	4"	AVIDRIO FA 40	71,57

Revestimiento de fibra de vidrio con velcro

Fibreglass with velcro shield

Rèvetement de fibre de verre avec velcro

Rivestimento di fibra di vetro con velcro



DIAMETER (mm) DIAMETRO (mm)	Part n° Referencia	€
1" 1/2 / 38 mm	ROVISIVE 24	117,68
2" / 50 mm	ROVISIVE 32	137,28
2" 3/4 - 70 mm	ROVISIVE 44	165,99

Cinta silicona

Silicone tape

Ruban silicone

Rotolo di Silicone



LENGTH (mm) LONGITUD (mm)	Part n° Referencia	€
Roll 11m	CSVIDRIO25	69,14
Roll 11m	CSVIDRIO38	103,33

Fibras

Fibers
Fibres
Fibre

AVIDRIO

Tubo de fibra de vidrio

Fibreglass tube

Fibra de alta calidad tipo E, no se quema y soporta exposiciones a temperaturas de 540 °C. Resiste la mayoría de ácidos y alcalinos y no le afecta la mayoría de disolventes ni lejías/blanqueantes.

High-quality fiber type E, no burns and supports exposure to temperatures of 540 °C. Resists most acids and alkalis and is unaffected by most solvents or bleach.



AVIDRIO S

Tubo de fibra de vidrio siliconado

Silicone fibreglass tube

Diseñado para proteger mangueras, alambres, etc. de los peligros del calor elevado y de las llamas ocasionales. Protección continua a 260 °C, soporta picos de hasta 1200 °C. Es resistente a fluidos hidráulicos, aceites lubricantes y combustibles. La funda siliconada protege contra la pérdida de energía en tubo rígido y manguera.

Designed to protect hoses, wires and cables from the hazards of high heat and occasional flame. It protects continuously to 260 °C and will withstand a molten splash at 1200 °C. Resistant to hydraulic fluids, lubricating oils and fuels, it insulates against energy loss in piping and hosing.



BVIDRIO S

Tubo de fibra de vidrio siliconado

Silicone fibreglass tube

Perfecto para proteger mangueras, tubos rígidos, etc. de elevadas temperaturas y llamas ocasionales. Ofrece protección continua a 260°C, con picos de hasta 1650°C. Resistente a salpicaduras de metales fundidos, fluidos hidráulicos, lubricantes y combustibles. La funda siliconada aísla el interior evitando la pérdida de energía en el tubo rígido o manguera.

Perfect to protect hoses, pipes and cables from high temperatures, it protects continuously to 260°C and a maximum of 1650°C. Resistant to splashes of molten metals, hydraulic fluids, lubricating oils and fuels. The silicone cover insulates against energy loss in piping and hosing.



AVIDRIO FA

Fibra de vidrio saturada

Saturated fibreglass tube

Proporciona protección continua hasta 540 °C. Es resistente a la mayoría de ácidos y alcalinos y no le afectan la mayoría de los disolventes ni lejías/blanqueantes. Es altamente flexible y adaptable; esto permite que una misma protección pueda colocarse en varios diámetros de tubo o incluso en montajes ya terminados (manguera/tubo + conexión/rácor). También es muy útil en longitudes largas de manguera o cable.

Provides continuous protection up to 540 °C. It is resistant to most acids and alkalis and is not affected by most of the solvents or bleach. It is highly flexible and adaptable, this allows to place the same protection on various diameters of pipe, or even on already finished assemblies (hose/pipe + connection/fitting). It is also useful in long lengths of hose or cable.

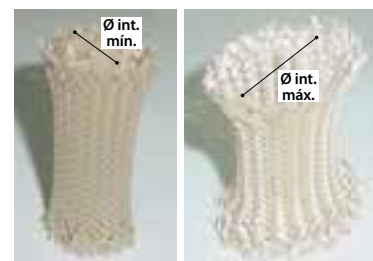

ROVISIVE

Revestimiento de fibra de vidrio siliconada con velcro

Silicon fibreglass with velcro shield

Diseñado para proteger mangueras, alambres, etc. de los peligros del calor elevado y de las llamas ocasionales. Protección continua a 260 °C, soporta picos de hasta 1200 °C. Su sistema de cierre con velcro permite el montaje *in situ* sin necesidad de quitar y poner los racores y terminales.

Designed to protect hoses, wires and cables from the hazards of high heat and occasional flame. It protects continuously to 260 °C and will withstand a molten splash at 1200 °C. Its Velcro closure system allows application in-situ without the need to dismantle and reconnect fittings and terminations.



ACERAMICA

Tubo de fibra cerámica

Ceramic fibre tube

La fibra cerámica está compuesta de silicato de aluminio. Es considerablemente resistente a altas temperaturas y tiene una estabilidad química excelente, resiste a los agentes más corrosivos, con la excepción del ácido fosfórico, ácido clorhídrico y bases fuertes. Tiene una excelente insonorización y aislamiento eléctrico, es de baja densidad y alta flexibilidad. No gotea en caso de incendio (no contiene agua). Sus características térmicas y físicas no se alteran por el agua, vapor o aceite.

Ceramic fibre is composed of aluminium silicate. Is considerably resistant to high temperatures and has excellent chemical stability, resists to most corrosive agents, with the exception of phosphoric acid, hydrochloric acid and strong alkalis. It has excellent soundproofing and electric insulation, low density and high flexibility. Not dripping in case of fire (does not contain water). Its thermal and physical characteristics are not altered by water, steam or oil.



Adaptors

Quick-release couplings

Ball valves

Diverters

Swivel fittings

Multi-way couplings

Protections

Protecciones textiles

Protections
Protection textile
Protezioni tessili

Tubo de protección textil

Textile protection tube

Gaine de protection textile

Tubo di protezioni tessile



L	Ø OUTER Ø EXT.	Ø INNER Ø INT.	Part nº Referencia	€
35	20	18	GT35	1,21
40	22	20	GT40	1,21
45	25	23	GT45	1,53
50	30	28	GT50	1,63
55	32	30	GT55	1,85
65	38	36	GT65	2,06
80	47	43	GT80	2,71
120	78	68	GT120	3,35
150	92	85	GT150	6,78

Accesorios tubo de protección textil

Textile protection tube accessories

Accessoires pour gaine de protection textile

Accessori per la protezione dei tessili



Ø Inner Min. Ø INT. MIN.	Ø Inner Max. Ø INT. MAX.	Part nº Referencia	€
13	15	ABRAZADERA 13-15	0,79
15	18	ABRAZADERA 15-18	0,93
20	23	ABRAZADERA 20-23	1,22
22	25	ABRAZADERA 22-25	1,40
23	27	ABRAZADERA 23-27	1,54
25	28	ABRAZADERA 25-28	1,54
40	43	ABRAZADERA 40-43	3,26
43	46	ABRAZADERA 43-46	3,48

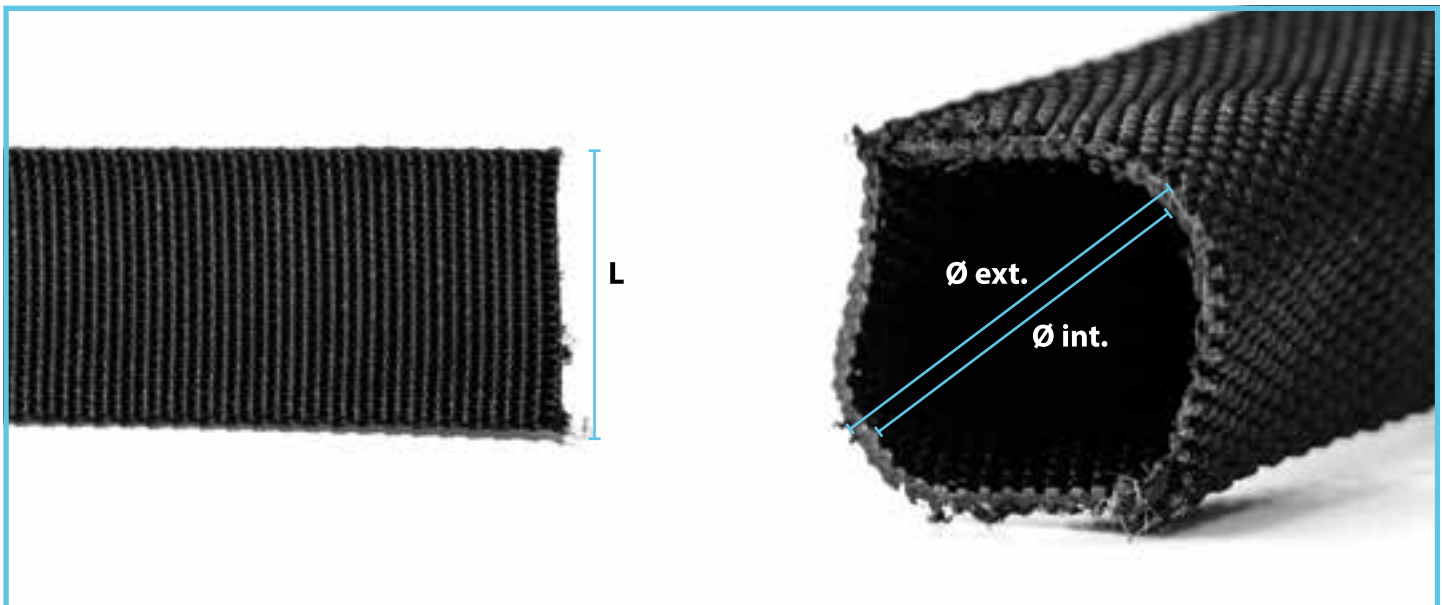

Fijaciones de seguridad

Safety fixation

Système de sécurité anti-fouet

Fune di sicurezza

Protección para DIN 2353

Retaining system to DIN 2353

Platines de fixation pour DIN 2353

Elementi di tenuta per DIN 2353

Ø INNER Ø INT.	DESCRIPTION DESCRIPCIÓN	MAX. PRESSURE (bar) PRESIÓN MAX. (bar)	Part n° Referencia	€
14.5 mm	8L - 1/4"	450	STOPFUDIN 145 CONF	24,74
17 mm	8S - 10L - 3/8"	445	STOPFUDIN 17 CONF	24,74
18.5 mm	10S - 12L	420	STOPFUDIN 185 CONF	24,74
20.5 mm	12S	420	STOPFUDIN 205 CONF	24,74
22.5 mm	14S - 15L - 1/2"	420	STOPFUDIN 225 CONF	25,11
24.5 mm	16S - 5/8"	420	STOPFUDIN 245 CONF	25,11
26.5 mm	18L - 3/4"	420	STOPFUDIN 265 CONF	25,11
30.5 mm	20S - 22L	420	STOPFUDIN 305 CONF	25,85
34 mm	1"	420	STOPFUDIN 34 CONF	27,70
36.5 mm	25S - 28L	420	STOPFUDIN 365 CONF	27,70
42.5 mm	30S - 1" 1/4	420	STOPFUDIN 425 CONF	28,07
45.5 mm	35L	420	STOPFUDIN 455 CONF	28,43
49 mm	1" 1/2	420	STOPFUDIN 49 CONF	28,80
52.5 mm	38S - 42L	385	STOPFUDIN 525 CONF	29,17
60 mm	2"	350	STOPFUDIN 60 CONF	29,54

Ver página 369 / See page 369 / Voir page 369 / Vedere p. 369

Protección para JIC 37°

Retaining system to JIC 37°

Platines de fixation pour JIC 37°

Elementi di tenuta per JIC 37°

Ø INNER Ø INT.	DESCRIPTION DESCRIPCIÓN	MAX. PRESSURE (bar) PRESIÓN MAX. (bar)	Part n° Referencia	€
11,5	7/16	450	STOPFUJIC 115 S	23,63
13,2	1/2	450	STOPFUJIC 132 S	23,63
14,8	9/16	450	STOPFUJIC 148 S	23,63
19,5	3/4	420	STOPFUJIC 195 S	23,63
22,8	7/8	420	STOPFUJIC 228 S	24,00
27,5	1 1/16	420	STOPFUJIC 275 S	24,74
30,7	1 3/16	420	STOPFUJIC 307 S	24,74
34	1 5/16	420	STOPFUJIC 34 L	30,28
34	1 5/16	420	STOPFUJIC 34 S	26,59
41,5	1 5/8	420	STOPFUJIC 415 L	31,39
41,5	1 5/8	420	STOPFUJIC 415 S	27,70
48	1 7/8	420	STOPFUJIC 48 L	31,39
48	1 7/8	420	STOPFUJIC 48 S	31,39
64	2 1/2	350	STOPFUJIC 64 L	39,88

Protección para DIN 2353 OPEN

Retaining system to DIN 2353 OPEN

Platines de fixation pour DIN 2353 OPEN

Elementi di tenuta per DIN 2353 OPEN

Ø INNER Ø INT.	DESCRIPTION DESCRIPCIÓN	MAX. PRESSURE (bar) PRESIÓN MAX. (bar)	Part n° Referencia	€
14.5 mm	8L - 1/4"	450	STOPFUDIN 145 OPEN	46,16
17 mm	8S - 10L - 3/8"	445	STOPFUDIN 17 OPEN	46,16
18.5 mm	10S - 12L	420	STOPFUDIN 185 OPEN	46,16
20.5 mm	12S	420	STOPFUDIN 205 OPEN	46,16
22.5 mm	14S - 15L - 1/2"	420	STOPFUDIN 225 OPEN	46,16
24.5 mm	16S - 5/8"	420	STOPFUDIN 245 OPEN	46,16
26.5 mm	18L - 3/4"	420	STOPFUDIN 265 OPEN	46,16
30.5 mm	20S - 22L	420	STOPFUDIN 305 OPEN	47,27
34 mm	1"	420	STOPFUDIN 34 OPEN	53,55
36.5 mm	25S - 28L	420	STOPFUDIN 365 OPEN	53,55
42.5 mm	30S - 1" 1/4	420	STOPFUDIN 425 OPEN	54,28
45.5 mm	35L	420	STOPFUDIN 455 OPEN	54,28
49 mm	1" 1/2	420	STOPFUDIN 49 OPEN	54,28
52.5 mm	38S - 42L	385	STOPFUDIN 525 OPEN	55,02
60 mm	2"	350	STOPFUDIN 60 OPEN	55,39

Protección para JIC 37° OPEN

Retaining system to JIC 37° OPEN

Platines de fixation pour JIC 37° OPEN

Elementi di tenuta per JIC 37° OPEN

Ø INNER Ø INT.	DESCRIPTION DESCRIPCIÓN	MAX. PRESSURE (bar) PRESIÓN MAX. (bar)	Part n° Referencia	€
11,5	7/16	450	STOPFUJIC 115 S OPEN	46,16
13,2	1/2	450	STOPFUJIC 132 S OPEN	46,16
14,8	9/16	450	STOPFUJIC 148 S OPEN	46,16
19,5	3/4	420	STOPFUJIC 195 S OPEN	46,16
22,8	7/8	420	STOPFUJIC 228 S OPEN	46,16
27,5	1 1/16	420	STOPFUJIC 275 S OPEN	47,27
30,7	1 3/16	420	STOPFUJIC 307 S OPEN	48,01
34	1 5/16	420	STOPFUJIC 34 L OPEN	53,55
34	1 5/16	420	STOPFUJIC 34 S OPEN	49,85
41,5	1 5/8	420	STOPFUJIC 415 L OPEN	54,65
41,5	1 5/8	420	STOPFUJIC 415 S OPEN	50,59
48	1 7/8	420	STOPFUJIC 48 L OPEN	55,02
48	1 7/8	420	STOPFUJIC 48 S OPEN	51,33
64	2 1/2	350	STOPFUJIC 64 L OPEN	55,76

Assembly where hoses have already been installed.



Montaje en mangueras previamente instaladas.

Fijaciones de seguridad

Safety fixation

Système de sécurité anti-fouet

Fune di sicurezza

Protección para bridas

Retaining system for flanges

Platines de fixation pour brides

Protezione per flangie



Ø INNER Ø INT.	DESCRIPTION DESCRIPCIÓN	MAX. PRESSURE (bar) PRESIÓN MAX. (bar)	Part n° Referencia	€
8.5 mm	SAE FLANGE 1/2" 3000 & 6000 PSI	415	STOPFUSAE 085 CONF	28,07
10,5	SAE FLANGE 3/4"-1" -1" 1/4 3000 PSI & 3/4" 6000 PSI	420	STOPFUSAE 2105 CONF	28,43
10.5 mm	SAE FLANGE 3/4"-1" -1" 1/4 3000 PSI & 3/4" 6000 PSI	420	STOPFUSAE 105 CONF	28,80
12.5 mm	SAE FLANGE 1"-1/2"-2" 3000 PSI & 1" 6000 PSI	420	STOPFUSAE 125 CONF	29,54
14.5 mm	SAE FLANGE 1" 1/4 6000 PSI	420	STOPFUSAE 145 CONF	29,54
16.5 mm	SAE FLANGE 1" 1/2 6000 PSI	420	STOPFUSAE 165 CONF	30,28
20.5 mm	SAE FLANGE 2" 6000 PSI	350	STOPFUSAE 205 CONF	30,28
25 MM	SAE FLANGE 2" 1/2 6000 PSI	350	STOPFUSAE 25 CONF	82,35
32 MM	SAE FLANGE 3" 6000 PSI	210	STOPFUSAE 32 CONF	86,78

Ver página 369 / See page 369 / Voir page 369 / Vedere p. 369

Abrazaderas

Fixation clamps

Colliers de fixation

Collari fissaggio



Ø INNER Ø INT.	Part n° Referencia	€
11-11.5 mm	STOPFA11115	7,76
12-12.5 mm	STOPFA12125	7,76
13-13.5 mm	STOPFA13135	7,76
14-15 mm	STOPFA1415	7,76
16-17 mm	STOPFA1617	7,76
17-18 mm	STOPFA1718	7,76
18-19 mm	STOPFA1819	7,76
20-21 mm	STOPFA2021	7,76
21-22 mm	STOPFA2122	7,76
22-23 mm	STOPFA2223	7,76
24-25 mm	STOPFA2425	8,12
25-26 mm	STOPFA2526	8,12
26-27 mm	STOPFA2627	8,12
27-28 mm	STOPFA2728	8,49
28-29 mm	STOPFA2829	8,49
30-31 mm	STOPFA3031	8,49
32-33 mm	STOPFA3233	8,49
34-35 mm	STOPFA3435	8,86
36-37 mm	STOPFA3637	8,86
38-39 mm	STOPFA3839	8,86
39-40 mm	STOPFA3940	8,86
40-41 mm	STOPFA4041	9,23
42-43 mm	STOPFA4243	9,23
43-44 mm	STOPFA4344	9,23
44-45 mm	STOPFA4445	9,23
45-47 mm	STOPFA4547	10,71
48-50 mm	STOPFA4850	10,71
51-53 mm	STOPFA5153	11,08
53-54 mm	STOPFA5354	11,08
54-56 mm	STOPFA5456	11,45
57-59 mm	STOPFA5759	11,45
60-62 mm	STOPFA6062	11,82
63-65 mm	STOPFA6365	11,82
66-68 mm	STOPFA6668	12,19
69-71 mm	STOPFA6971	12,19
72-74 mm	STOPFA7274	12,19
75-77 mm	STOPFA7577	12,19
78-80 mm	STOPFA7880	12,56
81-83 mm	STOPFA8183	12,56
84-86 mm	STOPFA8486	12,56
87-89 mm	STOPFA8789	12,93
90-92 mm	STOPFA9092	12,93
93-95 mm	STOPFA9395	13,29

Fijaciones de seguridad

Safety system

Système de sécurité anti-fouet

Fune di sicurezza

Referencia Part No. Référence Codice	Ø	SP	Recomendado para Recommended for Recommandé pour Consigliato per
STOPFUDIN 145 CONF	14,5	2,5	8L - 1/4"
STOPFUDIN 17 CONF	17	2,5	8S - 10L - 3/8"
STOPFUDIN 185 CONF	18,5	2,5	10S - 12L
STOPFUDIN 205 CONF	20,5	2,5	12S
STOPFUDIN 225 CONF	22,5	2,5	14S - 15L - 1/2"
STOPFUDIN 245 CONF	24,5	2,5	16S - 5/8"
STOPFUDIN 265 CONF	26,5	2,5	18L - 3/4"
STOPFUDIN 305 CONF	30,5	3	20S - 22L
STOPFUDIN 34 CONF	34	3	1"
STOPFUDIN 365 CONF	36,5	3	25S - 28L
STOPFUDIN 425 CONF	42,5	3	30S - 1 1/4"
STOPFUDIN 455 CONF	45,5	3	35L
STOPFUDIN 49 CONF	49	3	1 1/2"
STOPFUDIN 525 CONF	52,5	3	38S - 42L
STOPFUDIN 60 CONF	60	3	2"
STOPFUSAE 085 CONF	8,5	4	Brida SAE 1/2" 3000 y 6000 PSI
STOPFUSAE 105 CONF	10,5	4	Brida SAE 3/4" - 1" - 1 1/4" 3000 PSI y 3/4" 6000 PSI
STOPFUSAE 125 CONF	12,5	4	Brida SAE 1 1/2" - 2" 3000 PSI y 1" 6000 PSI
STOPFUSAE 145 CONF	14,5	4	Brida SAE 1" 1/4" 6000 PSI
STOPFUSAE 165 CONF	16,5	4	Brida SAE 1" 1/2" 6000 PSI
STOPFUSAE 205 CONF	20,5	4	Brida SAE 2" 6000 PSI

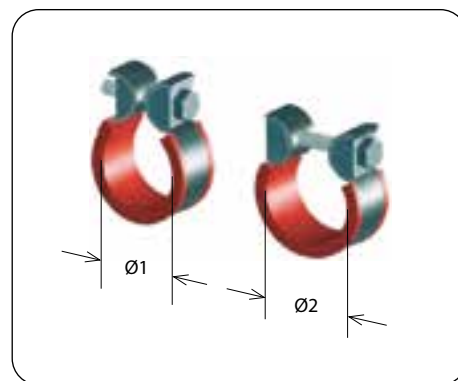
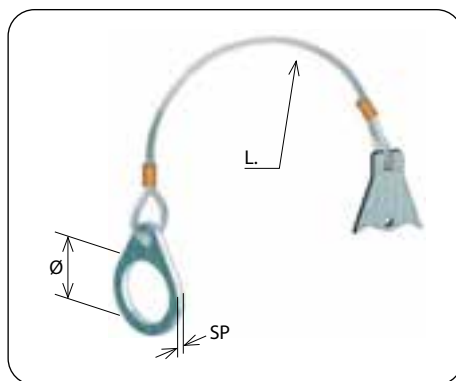
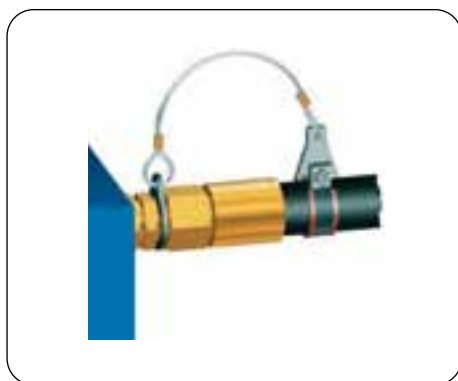

STOPFUDIN



STOPFUDIN



STOPFUSAE



COMPONENTES HIDRÁULICOS Y NEUMÁTICOS

HYDRAULIC AND PNEUMATIC COMPONENTS



DEPÓSITOS, FILTROS, CAMPANAS Y ACOPLAMIENTOS · TANKS, FILTERS, BELLHOUSINGS & COUPLINGS
 BOMBAS, DIVISORES DE CAUDAL Y MULTIPLICADORES · PUMPS, GEAR FLOW DIVIDERS & MULTIGEAR
 VÁLVULAS HIDRÁULICAS Y DISTRIBUIDORES HIDRÁULICOS · HYDRAULIC VALVES & HYDRAULIC CONTROL VALVES
 ELECTROVÁLVULAS, PLACAS BASE, EMPUÑADURAS Y SELECTORAS · DIRECTIONAL VALVES, SUBPLATES, JOYSTICKS & DIRECTIONAL VALVES
 ACUMULADORES, PRESOSTATOS E INTERCAMBIADORES DE CALOR · ACCUMULATORS, PRESSURE SWITCHES & HEAT EXCHANGERS
 MINICENTRALES, MOTORES LENTOS HIDRÁULICOS y CILINDROS HIDRÁULICOS · HYDRAULIC MOTORS, MINI POWER PACKS & HYDRAULIC CYLINDERS
 NEUMÁTICA: ACCESORIOS, VÁLVULAS, CILINDROS Y MICROCILINDROS · PNEUMATICS: ACCESSORIES, VALVES, CYLINDERS Y MICRO-CYLINDERS



Flexibles neumáticos*Tubes and springs*

Tubes et serpentins

Tubi e spirali

1

Racores neumáticos*Pneumatic fittings*

Raccords pneumatiques

Raccordi

2

Enchufes rápidos neumáticos*Quick release pneumatic couplings*

Coupleurs pneumatiques

Innesti rapidi

3

Flexibles neumáticos

Tubes and springs

Tubes et serpentins

Tubi e spirali

Tuberías de poliamida y poliuretano

378

Polyamide and polyurethane tubes

Tubes de polyamide et polyuréthane

Tubi in poliammide e poliuretano

Espirales de poliamida y poliuretano

380

Polyamide and Polyurethane springs

Serpentins polyamide y polyuréthane

Spirali in poliammide e poliuretano

1

Tuberías de poliamida y poliuretano

Polyamide and polyurethane tubes

Tubes de polyamide et polyuréthane

Tubi in poliammide e poliuretano

- PTFE sin malla / PTFE without braid / PTFE sans tresse / PTFE senza treccia

| 378



M2950

- Tuberías Poliamida natural / Natural polyamide pipe / Tubes polyamide naturelle / Tubi in Poliammide naturale

| 378



POL...NAT

- Tuberías Poliamida negro / Black polyamide pipe / Tubes polyamide noir / Tubi in Poliammide nero

| 378



POL...NE

- Tuberías Poliamida azul / Blue polyamide pipe / Tubes polyamide bleu / Tubi in Poliammide blu

| 379



POL...AZ

- Tuberías Poliuretano azul / Blue polyurethane pipe / Tubes polyuréthane bleu / Tubi in Poliuretano blu

| 379



PUR...AZ

Espirales de poliamida y poliuretano

Polyamide and Polyurethane springs
 Serpentins polyamide y polyuréthane
 Spirali in poliammide e poliuretano

- Espirales poliamida azul / Blue polyamide springs / Serpentins polyamide bleu / Spirali poliuretano blu | 380



ESPIRPOL

- Espirales poliuretano sin racores / Polyurethane springs without fittings / Serpentins polyuréthane sans raccords / Spirale poliuretano senza raccordi | 380



SPUR

- Espirales poliuretano con racores macho giratorio BSPT / Polyurethane springs with fittings swivel male BSPT / Serpentins polyuréthane avec raccords mâle tournant BSPT / Spirale poliuretano con raccordi maschio girevole BSPT | 380



HPUR

Tuberías de poliamida y poliuretano

Polyamide and polyurethane tubes

Tubes de polyamide et polyuréthane

Tubi in poliammide e poliuretano

PTFE sin malla

PTFE without braid

PTFE sans tresse

PTFE senza treccia



PIPE TUBO	LENGTH (M) LONGITUD (M)	Part n° Referencia	€
2x4	25	M2950204	85,73
4x6	25	M2950406	125,94
6x8	25	M2950608	182,17
2x4	100	M2950204-100	342,92
4x6	100	M2950406-100	503,66
6x8	100	M2950608-100	728,70

€/rollo / €/roll / €/rouleau / €/rotolo

Tuberías Poliamida natural

Natural polyamide pipe

Tubes polyamide naturelle

Tubi in Poliammide naturale



PIPE TUBO	LENGTH (M) LONGITUD (M)	Part n° Referencia	€
2,5x4 mm	25	POL2.5X4NAT	20,84
4x6 mm	25	POL4X6NAT	34,96
6x8 mm	25	POL6X8NAT	46,59
8x10 mm	25	POL8X10NAT	58,29
10x12 mm	25	POL10X12NAT	63,64
2,5x4 mm	100	POL2.5X4NAT-100	83,37
4x6 mm	100	POL4X6NAT-100	123,90
6x8 mm	100	POL6X8NAT-100	166,33
8x10 mm	100	POL8X10NAT-100	209,60
10x12 mm	100	POL10X12NAT-100	234,62

€/rollo / €/roll / €/rouleau / €/rotolo

Tuberías Poliamida negro

Black polyamide pipe

Tubes polyamide noir

Tubi in Poliammide nero



PIPE TUBO	LENGTH (M) LONGITUD (M)	Part n° Referencia	€
2,5x4 mm	25	POL2.5X4NE	14,84
4x6 mm	25	POL4X6NE	19,96
6x8 mm	25	POL6X8NE	24,15
8x10 mm	25	POL8X10NE	37,00
10x12 mm	25	POL10X12NE	44,96
2,5x4 mm	100	POL2.5X4NE-100	59,86
4x6 mm	100	POL4X6NE-100	70,69
6x8 mm	100	POL6X8NE-100	102,16
8x10 mm	100	POL8X10NE-100	124,75
10x12 mm	100	POL10X12NE-100	156,60

€/rollo / €/roll / €/rouleau / €/rotolo

Tuberías de poliamida y poliuretano

Polyamide and polyurethane tubes
Tubes de polyamide et polyuréthane
Tubi in poliammide e poliuretano

Tuberías Poliamida azul

Blue polyamide pipe

Tubes polyamide bleu

Tubi in Poliammide blu



PIPE TUBO	LENGTH (M) LONGITUD (M)	Part nº Referencia	€
4x6 mm	25	POL4X6AZ	30,02
6x8 mm	25	POL6X8AZ	39,89
8x10 mm	25	POL8X10AZ	54,31
10x12 mm	25	POL10X12AZ	64,58
4x6 mm	100	POL4X6AZ-100	96,48
6x8 mm	100	POL6X8AZ-100	116,43
8x10 mm	100	POL8X10AZ-100	191,28
10x12 mm	100	POL10X12AZ-100	199,59

€/rollo / €/roll / €/rouleau / €/rotolo

Tuberías Poliuretano azul

Blue polyurethane pipe

Tubes polyuréthane bleu

Tubi in Poliuretano blu



PIPE TUBO	LENGTH (M) LONGITUD (M)	Part nº Referencia	€
2x4 mm	25	PUR2X4AZ	24,76
4x6 mm	25	PUR4X6AZ	35,78
6x8 mm	25	PUR6X8AZ	47,85
8x10 mm	25	PUR8X10AZ	59,65
9x12 mm	25	PUR9X12AZ	122,30
2,5x4 mm	100	PUR2.5X4AZ-100	46,62
4x6 mm	100	PUR4X6AZ-100	81,05
6x8 mm	100	PUR6X8AZ-100	123,15
6,5x10 mm	100	PUR6.5X10AZ-100	209,59
8x12 mm	100	PUR8X12AZ-100	275,53

€/rollo / €/roll / €/rouleau / €/rotolo

Espirales de poliamida y poliuretano

Polyamide and Polyurethane springs
Serpentins polyamide y polyuréthane
Spirali in poliammide e poliuretano

Espirales poliamida azul

Blue polyamide springs

Serpentins polyamide bleu



Spirali poliuretano blu

PIPE TUBO	Ø INNER Ø INT.	LENGTH (M) LONGITUD (M)	Part n° Referencia	€
4x6 mm	50	30	ESPIRPOL4X6AZ	37,42
6x8 mm	70	30	ESPIRPOL6X8AZ	48,21
8x10 mm	85	30	ESPIRPOL8X10AZ	122,30
10x12 mm	110	30	ESPIRPOL10X12AZ	151,89

€/rollo / €/roll / €/rouleau / €/rotolo

Espirales poliuretano sin racores

Polyurethane springs without fittings

Serpentins polyuréthane sans raccords



Spirale poliuretano senza raccordi

PIPE TUBO	Ø INNER Ø INT.	LENGTH (M) LONGITUD (M)	Part n° Referencia	€
4x6 mm	32	5	SPUR4X6 5	5,11
4x6 mm	32	7,5	SPUR4X6 7.5	9,09
4x6 mm	32	10	SPUR4X6 10	11,72
5X8 mm	40	5	SPUR5X8 5	8,69
5X8 mm	40	7,5	SPUR5X8 7.5	12,90
5X8 mm	40	10	SPUR5X8 10	17,84
6,5x10 mm	46	5	SPUR6.5X10 5	12,52
6,5x10 mm	46	7,5	SPUR6.5X10 7.5	18,64
6,5x10 mm	46	10	SPUR6.5X10 10	26,25

€/rollo / €/roll / €/rouleau / €/rotolo

Espirales poliuretano con racores macho giratorio BSPT

*Polyurethane springs with fittings swivel male
BSPT*

Serpentins polyuréthane avec raccords mâle
tournant BSPT



*Spirale poliuretano con raccordi maschio girevole
BSPT*

PIPE TUBO	Ø INNER Ø INT.	LENGTH (M) LONGITUD (M)	Part n° Referencia	€
4x6 mm	32	5	HPUR4X6 5	47,39
4x6 mm	32	7,5	HPUR4X6 7.5	54,77
4x6 mm	32	10	HPUR4X6 10	59,62
5X8 mm	40	5	HPUR5X8 5	16,12
5X8 mm	40	7,5	HPUR5X8 7.5	21,46
5X8 mm	40	10	HPUR5X8 10	25,67
6,5x10 mm	46	5	HPUR6.5X10 5	21,81
6,5x10 mm	46	7,5	HPUR6.5X10 7.5	21,81
6,5x10 mm	46	10	HPUR6.5X10 10	27,94

€/rollo / €/roll / €/rouleau / €/rotolo

Selecciona un producto de nuestro catálogo de productos
Select a product from our product catalog

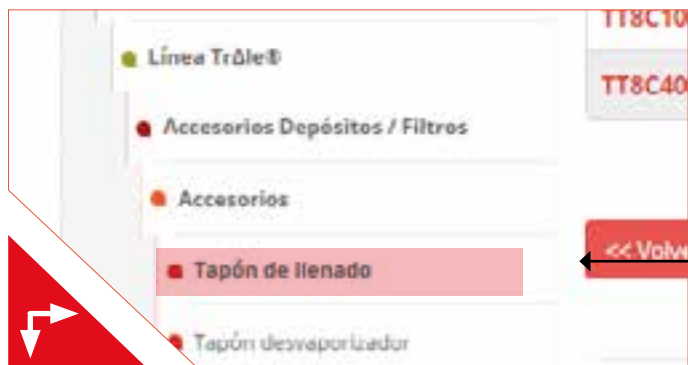

Haz clic en "Documentación técnica" debajo de la tabla
Click on "Technical Documentation" under the table

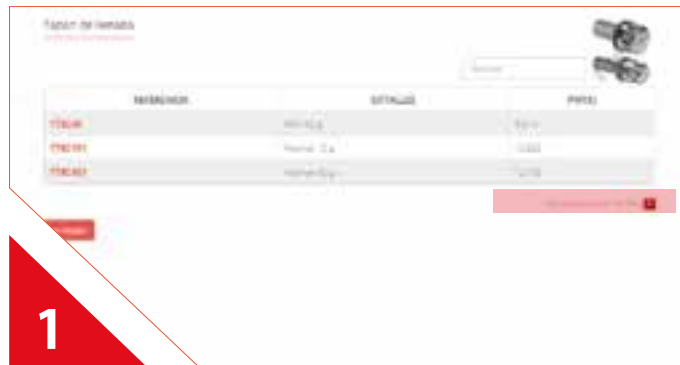

También puedes hacer clic en una referencia de la tabla
You can also click on any reference of a table



Haz clic en "Documentación técnica"
Click on "Technical Documentation"



Se abrirá un archivo PDF con los datos técnicos que podrá guardar en su ordenador.
A PDF file will appear with the technical data, which can be saved in your computer.

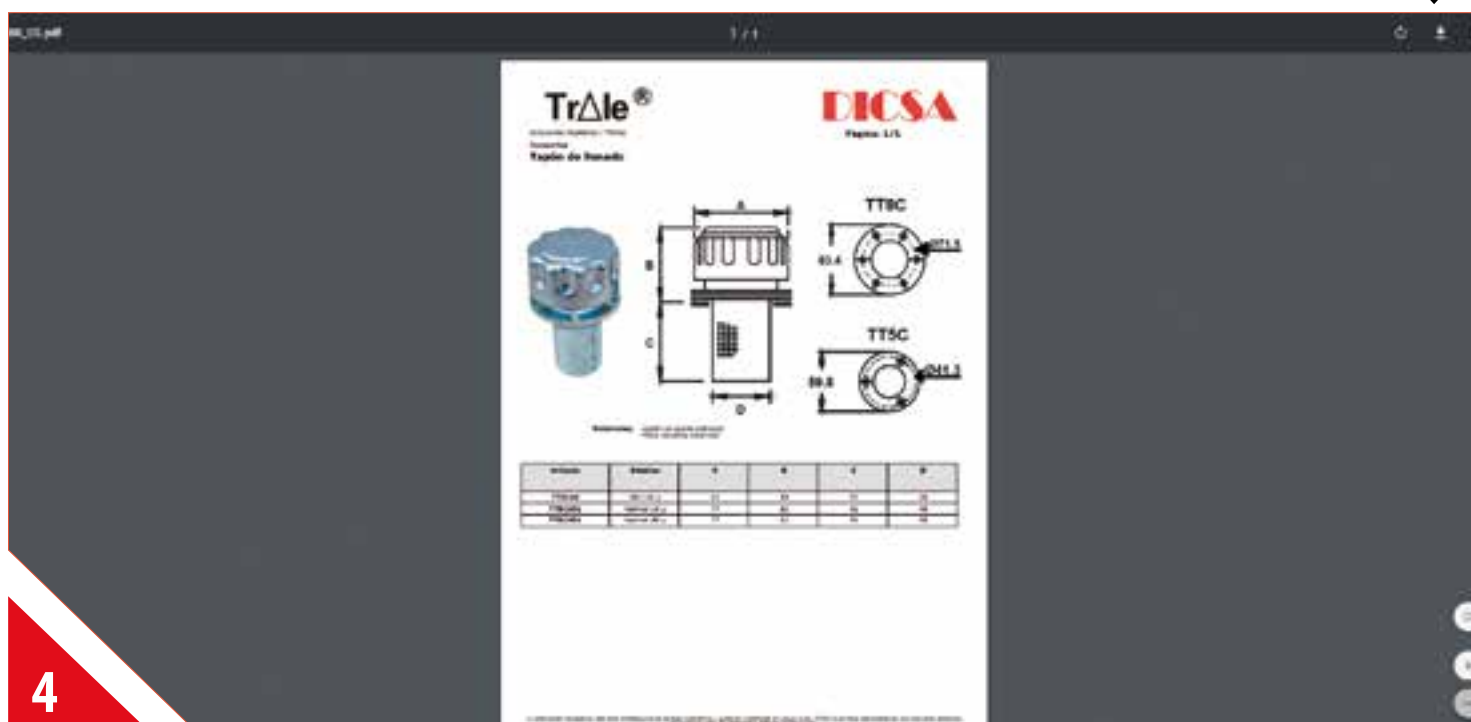

Racores neumáticos

Pneumatic fittings

Raccords pneumatiques

Raccordi

Conexión Push-in automático

389

Push-in Fittings

Raccords Automatiques Push-in

Raccordi automatici Push-in

Conexión con espiga

398

Hose tail-M BSPT tapered

Raccords avec embout

Raccordi con inserto

Conexión Push-on

399

Push-on Fittings

Raccords Push-on

Raccordi Push-on

Adaptador

403

Adaptors

Adaptateurs

Adattatori

2

Conexión Push-in automático

Push-in Fittings

Raccords Automatiques Push-in

Raccordi automatici Push-in

■ Racordaje tecnopolímero cónico / Push-in Technopolymeric tapered fittings / Raccords Push-in techno-polymère conique / Raccordi tecnopolimero Push-in conico | 389



■ Racordaje tecnopolímero cilíndrico / Push-in Technopolymeric cylindrical fittings / Raccords Push-in techno-polymère cylindrique / Raccordi tecnopolimero Push-in cilindrico | 390



■ Racordaje tecnopolímero otros / Other Push-in Technopolymeric fittings / Raccords Push-in techno-polymère - autres / Raccordi tecnopolimero Push-in altri | 392



■ Racordaje metálico cónico / Metallic Push-in tapered fittings / Raccords Push-in métallique conique / Raccordi metallici Push-in conico | 395



Conexión Push-in automático

Push-in Fittings

Raccords Automatiques Push-in

Raccordi automatici Push-in

- Racordaje metálico cilíndrico / Metallic Push-in cylindrical fittings / Raccords Push-in métallique cylindrique / Raccordi metallici Push-in cilindrico | 395



MPCCI



MPCF



MPHCI



MPLCI



MSCL



MPTCI



MPSTCI

- Racordaje metálico otros / Other Metallic Push-in fittings / Raccords Push-in métallique - autres / Raccordi metallici Push-in vari | 396



MPUC



MPMM



MPUL



MPUT



MPY



TAP



50600

Conexión con espiga

Hose tail-M BSPT tapered

Raccords avec embout

Raccordi con inserto

- Racordaje con espiga cónico / Tapered hose tail fittings / Raccords avec embout conique / Raccordi con inserto conico | 398



3040



3055

- Racordaje con espiga cilíndrico / Cylindrical hose tail fittings / Raccords avec embout cylindrique / Raccordi con inserto cilindrico | 398



3045



3050



3045A

Conexión Push-on

Push-on Fittings
Raccords Push-on
Raccordi Push-on

■ Conexión Push-on sin espiral / Push-on fittings without spring / Raccords Push-on sans spirale / Raccordi Push-on sin spirali | 399



■ Conexión Push-on con muelle / Push-on fittings with nut and spring / Raccords Push-on avec ressort / Raccordi Push-on senza molla | 402



Adaptador

Adaptors
Adaptateurs
Adattatori

■ Adaptadores Rectos / Straight adaptors / Adaptateurs droits / Adattatori diritti

| 403



■ Tapones / Plugs / Bouchons / Tappi

| 405



■ Forja en codo / Elbow forge / Forges en coude / Forgiato a 90°

| 406



■ Forja en T / Forge in T / Forges en T / Forgiato a T

| 406



■ Forja en Cruz e Y / Forge in Cross and Y / Forges en Croix et Y / Forgiato a croce e Y

| 407



■ Tacos / Squares / Nourrices de distribution / Blocco a croce

| 407



Conexión Push-in automático

Push-in Fittings

Raccords Automatiques Push-in

Raccordi automatici Push-in

Auto. Pol.-M BSPT cónico/M métrico

Push-in Pol. - M BSPT tapered/M metric

Push-in Pol. - M BSPT conique /M métrique

Automatico diritto maschio



PIPE TUBO	THREAD ROSCA	Part n° Referencia	€
4 mm	1/8"	PC 0401	0,72
4 mm	1/4"	PC 0402	1,02
4 mm	M5	PC 04M5	0,67
6 mm	1/8"	PC 0601	0,88
6 mm	1/4"	PC 0602	1,10
6 mm	3/8"	PC 0603	1,55
8 mm	1/8"	PC 0801	1,11
8 mm	1/4"	PC 0802	1,17
8 mm	3/8"	PC 0803	1,59
8 mm	1/2"	PC 0804	2,71
10 mm	1/8"	PC 1001	1,58
10 mm	1/4"	PC 1002	1,80
10 mm	3/8"	PC 1003	1,74
10 mm	1/2"	PC 1004	2,59
12 mm	1/4"	PC 1202	2,44
12 mm	3/8"	PC 1203	2,49
12 mm	1/2"	PC 1204	3,07

Auto. Pol.-codo orientable M BSPT cónico

Push-in Pol. - elbow banjo M BSPT tapered

Push-in Pol. - coude ajustable M BSPT conique

Automatico estremita tubolare a 90



PIPE TUBO	THREAD ROSCA	Part n° Referencia	€
4 mm	1/8"	PH 0401	1,48
6 mm	1/8"	PH 0601	1,66
6 mm	1/4"	PH 0602	2,25
8 mm	1/8"	PH 0801	1,72
8 mm	1/4"	PH 0802	6,55
8 mm	3/8"	PH 0803	3,40
10 mm	1/4"	PH 1002	2,38
10 mm	3/8"	PH 1003	3,83

Auto. Pol.-codo giratorio M BSPT cónico

Push-in Pol. - elbow adjustable M BSPT tapered

Push-in Pol. - coude tournant M BSPT conique

Automatico maschio girevole



PIPE TUBO	THREAD ROSCA	Part n° Referencia	€
4 mm	1/8"	PL 0401	0,90
4 mm	1/4"	PL 0402	1,31
6 mm	1/8"	PL 0601	1,11
6 mm	1/4"	PL 0602	1,40
6 mm	3/8"	PL 0603	1,81
8 mm	1/8"	PL 0801	1,52
8 mm	1/4"	PL 0802	1,66
8 mm	3/8"	PL 0803	1,98
10 mm	1/4"	PL 1002	2,25
10 mm	3/8"	PL 1003	2,29
10 mm	1/2"	PL 1004	3,35
12 mm	3/8"	PL 1203	3,33
12 mm	1/2"	PL 1204	3,54

Auto. Pol.-codo giratorio prolongado M BSPT cónico

Push-in Pol. - elbow adjustable extensor M BSPT tapered

Push-in Pol. - coude tournant prolongé M BSPT conique

Automatico a 90 prolunga maschio girevole



PIPE TUBO	THREAD ROSCA	Part n° Referencia	€
4 mm	1/8"	PLL 0401	1,32
4 mm	1/4"	PLL 0402	2,00
6 mm	1/8"	PLL 0601	1,77
6 mm	1/4"	PLL 0602	2,18
8 mm	1/8"	PLL 0801	2,29
8 mm	3/8"	PLL 0803	3,02
10 mm	1/4"	PLL 1002	4,05

Auto. Pol.-T central giratorio M BSPT cónico

Push-in Pol. - Tee central adjustable M BSPT tapered

Push-in Pol. - T central tournant M BSPT conique

Automatico T maschio girevole centrale



PIPE TUBO	THREAD ROSCA	Part n° Referencia	€
4 mm	1/8"	PT 0401	1,30
6 mm	1/8"	PT 0601	1,50
6 mm	1/4"	PT 0602	1,81
8 mm	1/8"	PT 0801	1,84
8 mm	1/4"	PT 0802	1,98
10 mm	1/4"	PT 1002	3,04
10 mm	3/8"	PT 1003	2,81
12 mm	3/8"	PT 1203	3,73
12 mm	1/2"	PT 1204	3,23

Auto. Pol.-T lateral giratorio M BSPT cónico

Push-in Pol. - Tee lateral adjustable M BSPT tapered

Push-in Pol. - T lateral tournant M BSPT conique

Automatico T maschio girevole laterale



PIPE TUBO	THREAD ROSCA	Part n° Referencia	€
4 mm	1/8"	PST 0401	1,30
6 mm	1/8"	PST 0601	1,50
6 mm	1/4"	PST 0602	1,81
8 mm	1/8"	PST 0801	1,89
8 mm	1/4"	PST 0802	2,14
10 mm	1/4"	PST 1002	2,57
10 mm	3/8"	PST 1003	2,66
12 mm	3/8"	PST 1203	3,79
12 mm	1/2"	PST 1204	3,84

Conexión Push-in automático

Push-in Fittings

Raccords Automatiques Push-in

Raccordi automatici Push-in

Auto. Pol.-Y central M BSPT cónico/M métrico

Push-in Pol. - Y central M BSPT tapered/M metric

Push-in Pol. - Y central M BSPT conique /M métrique

Automatico automatico a Y maschio girevole centrale



PIPE TUBO	THREAD ROSCA	Part nº Referencia	€
4 mm	1/8"	PWT 0401	1,32
4 mm	1/4"	PWT 0402	1,88
4 mm	M5	PWT 04M5	1,28
6 mm	1/8"	PWT 0601	1,79
6 mm	1/4"	PWT 0602	2,07
8 mm	1/8"	PWT 0801	1,98
8 mm	1/4"	PWT 0802	2,11
10 mm	1/4"	PWT 1002	3,50
10 mm	3/8"	PWT 1003	3,31
12 mm	3/8"	PWT 1203	4,67
12 mm	1/2"	PWT 1204	5,21

Auto. Pol.-codo microrregulador p/cilindro M BSPT cónico

Push-in Pol. - elbow speed controller for cylinder M BSPT tapered

Push-in Pol. - coude micro-regulateur M BSPT conique

Microregolatore per cilindro BSPT



PIPE TUBO	THREAD ROSCA	Part nº Referencia	€
4 mm	1/8"	SCLT 0401	3,93
4 mm	1/4"	SCLT 0402	4,70
6 mm	1/4"	SCLT 0602	4,66
6 mm	3/8"	SCLT 0603	7,38
8 mm	1/8"	SCLT 0801	4,27
8 mm	1/4"	SCLT 0802	4,56
8 mm	3/8"	SCLT 0803	7,84
10 mm	1/4"	SCLT 1002	4,97
10 mm	3/8"	SCLT 1003	8,30
12 mm	1/4"	SCLT 1202	5,71

Auto. Pol.-múltiple intermedio M BSPT cónico

Push-in Pol.-multiple union M BSPT tapered

Push-in Pol.-intermédiaire multiple M BSPTconique

Automatico maschio con uscite multiple



PIPE TUBO		THREAD ROSCA	Part nº Referencia	€
6 mm	4 mm	1/8"	PKD 060401	3,35
8 mm	4 mm	1/4"	PKD 080402	3,71
8 mm	6 mm	1/4"	PKD 080602	3,71
10 mm	8 mm	3/8"	PKD 100803	5,38

Auto. Pol.-M BSP cilíndrico/M métrico c/junta

Push-in Pol. - M BSP parallel/M metric w/o'ring

Push-in Pol. - coude tournant M BSP cilindrique /M métrique avec o'ring

Automatico diritto maschio con o'ring



PIPE TUBO	THREAD ROSCA	Part nº Referencia	€
4 mm	1/8"	PCCI 0401	0,79
4 mm	1/4"	PCCI 0402	1,24
4 mm	M5	PCCI 04M5	0,79
6 mm	1/8"	PCCI 0601	1,03
6 mm	1/4"	PCCI 0602	1,21
6 mm	3/8"	PCCI 0603	1,63
8 mm	1/8"	PCCI 0801	1,24
8 mm	1/4"	PCCI 0802	1,16
8 mm	3/8"	PCCI 0803	1,58
10 mm	1/4"	PCCI 1002	1,78
10 mm	3/8"	PCCI 1003	1,91
10 mm	1/2"	PCCI 1004	2,63
12 mm	1/4"	PCCI 1202	2,80
12 mm	3/8"	PCCI 1203	3,04
12 mm	1/2"	PCCI 1204	3,39

Auto. Pol.-H BSP cilíndrico

Push-in Pol. - F BSP parallel

Push-in Pol. - F BSP cilindrique

Automatico diritto femmina



PIPE TUBO	THREAD ROSCA	Part nº Referencia	€
4 mm	1/8"	PCF 0401	1,12
6 mm	1/8"	PCF 0601	1,21
6 mm	1/4"	PCF 0602	1,65
8 mm	1/8"	PCF 0801	1,29
8 mm	1/4"	PCF 0802	1,62
8 mm	3/8"	PCF 0803	2,43
10 mm	1/4"	PCF 1002	1,86
12 mm	3/8"	PCF 1203	2,58

Conexión Push-in automático

Push-in Fittings

Raccords Automatiques Push-in

Raccordi automatici Push-in

Auto. Pol.-codo orientable M BSP cilíndrico/M métrico c/junta

Push-in Pol. - elbow banjo M BSP parallel/M metric w/o'ring

Push-in Pol. - coude orientable M BSP cylindrique /M métrique avec o'ring



Automatico orientable a 90 con o'ring

PIPE TUBO	THREAD ROSCA	Part nº Referencia	€
4 mm	1/8"	PHCI 0401	4,66
4 mm	M5	PHCI 04M5	1,54
6 mm	1/8"	PHCI 0601	4,66
6 mm	1/4"	PHCI 0602	5,53
8 mm	1/8"	PHCI 0801	2,14
8 mm	1/4"	PHCI 0802	5,60
8 mm	3/8"	PHCI 0803	7,38
10 mm	3/8"	PHCI 1003	3,84

Auto. Pol.-codo giratorio M BSP cilíndrico/M métrico c/junta

Push-in Pol. - elbow adjustable M BSP parallel/M metric w/o'ring

Push-in Pol. - coude tournant M BSP cylindrique /M métrique avec o'ring



Automatico maschio a 90 girevole con o'ring

PIPE TUBO	THREAD ROSCA	Part nº Referencia	€
4 mm	1/8"	PLCI 0401	0,93
4 mm	1/4"	PLCI 0402	1,36
4 mm	M5	PLCI 04M5	0,93
6 mm	1/8"	PLCI 0601	1,23
6 mm	1/4"	PLCI 0602	1,50
6 mm	3/8"	PLCI 0603	2,00
6 mm	M5	PLCI 06M5	1,14
8 mm	1/8"	PLCI 0801	1,44
8 mm	1/4"	PLCI 0802	1,93
8 mm	3/8"	PLCI 0803	2,14
10 mm	1/4"	PLCI 1002	2,59
10 mm	3/8"	PLCI 1003	2,53
10 mm	1/2"	PLCI 1004	3,20
12 mm	1/4"	PLCI 1202	3,82
12 mm	3/8"	PLCI 1203	3,81
12 mm	1/2"	PLCI 1204	3,39

Auto. Pol.-codo giratorio cuerpo metálico M BSP cilíndrico/M métrico c/junta

Push-in Pol. - elbow adjustable metallic body M BSP parallel/M metric w/o'ring

Push-in Pol. - coude tournant corps métallique M BSP cylindrique /M métrique avec o'ring



Automatico a 90 maschio girevole con o'ring

PIPE TUBO	THREAD ROSCA	Part nº Referencia	€
4 mm	1/8"	50115 4 1/8	4,76
4 mm	M5	50115 4 M5	4,69
6 mm	1/8"	50115 6 1/8	4,84
6 mm	1/4"	50115 6 1/4	5,23
6 mm	M5	50115 6 M5	4,69
8 mm	1/8"	50115 8 1/8	5,55
8 mm	1/4"	50115 8 1/4	5,82
8 mm	3/8"	50115 8 3/8	7,03
10 mm	1/4"	50115 10 1/4	7,35
10 mm	3/8"	50115 10 3/8	8,09
10 mm	1/2"	50115 10 1/2	9,11
12 mm	3/8"	50115 12 3/8	9,26
12 mm	1/2"	50115 12 1/2	10,51

Auto. Pol.-codo microrregulador p/cilindro M BSP cilíndrico/M métrico

Push-in Pol. - elbow speed controller for cylinder M BSP parallel/M metric

Push-in Pol. - coude micro-régulateur M BSP cylindrique /M métrique



Microregolatore per cilindro BSP

PIPE TUBO	THREAD ROSCA	Part nº Referencia	€
4 mm	1/8"	SCL 0401	3,66
4 mm	1/4"	SCL 0402	4,11
4 mm	M5	SCL 04M5	3,23
6 mm	1/8"	SCL 0601	4,35
6 mm	1/4"	SCL 0602	4,56
6 mm	3/8"	SCL 0603	6,98
6 mm	M5	SCL 06M5	3,48
8 mm	1/8"	SCL 0801	4,35
8 mm	1/4"	SCL 0802	4,56
8 mm	3/8"	SCL 0803	7,27
10 mm	1/4"	SCL 1002	4,97
10 mm	3/8"	SCL 1003	7,34
12 mm	1/4"	SCL 1202	4,82
12 mm	3/8"	SCL 1203	7,43
12 mm	1/2"	SCL 1204	10,59

Auto. Pol.-T central giratorio M BSP cilíndrico c/junta

Push-in Pol. - Tee central adjustable M BSP parallel w/o'ring

Push-in Pol. - T central tournant M BSP cylindrique avec o'ring



Automatico T girevole centrale con o'ring

PIPE TUBO	THREAD ROSCA	Part nº Referencia	€
4 mm	1/8"	PTCI 0401	1,23
4 mm	M5	PTCI 04M5	1,20
6 mm	1/8"	PTCI 0601	2,03
6 mm	M5	PTCI 06M5	1,49
8 mm	1/8"	PTCI 0801	1,85
8 mm	3/8"	PTCI 0803	2,26
10 mm	1/4"	PTCI 1002	7,95
10 mm	3/8"	PTCI 1003	8,24
12 mm	3/8"	PTCI 1203	5,12

Auto. Pol.-T central giratorio cuerpo metálico M BSP cilíndrico c/junta

Push-in Pol. - Tee central adjustable metallic body M BSP parallel w/o'ring

Push-in Pol. - T central tournant corps métallique M BSP cylindrique avec o'ring



Automatico a T maschio girevole centrale con o'ring

PIPE TUBO	THREAD ROSCA	Part nº Referencia	€
4 mm	1/8"	50215 4 1/8	6,69
4 mm	1/4"	50215 4 1/4	7,14
6 mm	1/8"	50215 6 1/8	6,72
6 mm	1/4"	50215 6 1/4	7,14
8 mm	1/8"	50215 8 1/8	8,20
8 mm	1/4"	50215 8 1/4	8,39
10 mm	1/4"	50215 10 1/4	10,86
10 mm	3/8"	50215 10 3/8	11,30
12 mm	3/8"	50215 12 3/8	12,56
12 mm	1/2"	50215 12 1/2	14,02

Conexión Push-in automático

Push-in Fittings

Raccords Automatiques Push-in

Raccordi automatici Push-in

Auto. Pol.-T lateral giratorio M BSP cilíndrico c/junta

Push-in Pol. - T lateral adjustable M BSP parallel w/o ring

Push-in Pol. - T lateral tournant M BSP cylindrique avec o'ring

Automatico T girevole laterale con o'ring



PIPE TUBO	THREAD ROSCA	Part nº Referencia	€
4 mm	1/8"	PSTCI 0401	4,62
6 mm	1/8"	PSTCI 0601	4,67
6 mm	1/4"	PSTCI 0602	4,99
8 mm	1/8"	PSTCI 0801	5,70
8 mm	1/4"	PSTCI 0802	3,80
10 mm	1/4"	PSTCI 1002	7,95
10 mm	3/8"	PSTCI 1003	8,24
12 mm	3/8"	PSTCI 1203	8,93

Auto. Pol.-T lateral giratorio cuerpo metálico M BSP cilíndrico c/junta

Push-in Pol. - T lateral adjustable metallic body M BSP parallel w/o ring

Push-in Pol. - T lateral tournant corps métallique M BSP cylindrique avec o'ring

Automatico a T maschio girevole laterale con o'ring



PIPE TUBO	THREAD ROSCA	Part nº Referencia	€
4 mm	1/8"	50225 4 1/8	6,69
6 mm	1/8"	50225 6 1/8	6,72
6 mm	1/4"	50225 6 1/4	7,14
8 mm	1/8"	50225 8 1/8	8,20
8 mm	1/4"	50225 8 1/4	8,39
10 mm	1/4"	50225 10 1/4	10,86
10 mm	3/8"	50225 10 3/8	11,30
12 mm	3/8"	50225 12 3/8	12,56

Auto. Pol.-intermedio

Push-in Pol.-union

Push-in technopolymère - Union à piquage

Automatico intermedio



PIPE TUBO	PIPE TUBO	Part nº Referencia	€
6 mm	4 mm	PG 0604	0,74
8 mm	6 mm	PG 0806	1,06
10 mm	8 mm	PG 1008	1,14
12 mm	10 mm	PG 1210	1,45
4 mm	4 mm	PUC 04	0,69
6 mm	6 mm	PUC 06	0,76
8 mm	8 mm	PUC 08	0,83
10 mm	10 mm	PUC 10	1,04
12 mm	12 mm	PUC 12	1,27

Auto. Pol.-intermedio cuerpo metálico

Push-in Pol.-union metallic body

Push-in technopolymère - Piquage corps métallique

Automatico intermedio



PIPE TUBO	Part nº Referencia	€
4 mm	50040 4	2,38
6 mm	50040 6	2,76
8 mm	50040 8	3,22
10 mm	50040 10	5,38
12 mm	50040 12	6,75

Auto. Pol.-intermedio pasatabique tuerca métrica

Push-in Pol.-union bulkhead w/metric nut

Push-in technopolymère - Piquage passe-cloison métrique

Automatico intermedio passaparete



PIPE TUBO	THREAD ROSCA	Part nº Referencia	€
4 mm	M12x1	PMM 04	2,25
6 mm	M14x1	PMM 06	2,33
8 mm	M16x1	PMM 08	2,65
10 mm	M20x1	PMM 10	4,10
12 mm	M22x1	PMM 12	5,11

Auto. Pol.-regulador en línea unidireccional

Push-in Pol.-unidirectional straight speed controller

Push-in technopolymère - Régulateur de débit en ligne unidirectionnel

Regolatore di flusso in linea



PIPE TUBO	Part nº Referencia	€
4 mm	SCU 04	4,02
6 mm	SCU 06	4,47
8 mm	SCU 08	4,88
10 mm	SCU 10	6,88

Auto. Pol.-reductor insertable

Push-in Pol.-plug-in reducer

Push-in technopolymère - Piquage de réduction

Automatico di riduzione



PIPE TUBO	PIPE TUBO	Part nº Referencia	€
6 mm	4 mm	PR 0604	0,89
8 mm	4 mm	PR 0804	0,81
8 mm	6 mm	PR 0806	0,89
10 mm	6 mm	PR 1006	0,98
10 mm	8 mm	PR 1008	1,15
12 mm	8 mm	PR 1208	1,54
12 mm	10 mm	PR 1210	1,63

Auto. Pol.-reductor insertable cuerpo metálico

Push-in Pol.-plug-in reducer metallic body

Push-in technopolymère - Piquage de réduction corps métallique

Automatico di riduzione corpo metallico



PIPE TUBO	PIPE TUBO	Part nº Referencia	€
6 mm	4 mm	PRM 0604	1,43
8 mm	4 mm	PRM 0804	1,54
8 mm	6 mm	PRM 0806	1,54
10 mm	6 mm	PRM 1006	1,71
10 mm	8 mm	PRM 1008	1,73
12 mm	8 mm	PRM 1208	2,05
12 mm	10 mm	PRM 1210	2,05

Conexión Push-in automático

Push-in Fittings

Raccords Automatiques Push-in

Raccordi automatici Push-in

Auto. Pol.-cuerpo orientable metálico

Push-in Pol.-banjo body metallic body

Push-in technopolymère - Corps orientable métallique

Automatico orientabile



PIPE TUBO	THREAD ROSCA	Part n° Referencia	€
4 mm	M5	50500 4 M5	3,78
4 mm	M6	50500 4 M6	3,78
4 mm	1/2"	50500 4 1/8	3,90
6 mm	M5	50500 6 M5	3,90
6 mm	M6	50500 6 M6	3,90
6 mm	1/8"	50500 6 1/8	4,07
6 mm	1/4"	50500 6 1/4	4,39
8 mm	1/8"	50500 8 1/8	4,54
8 mm	1/4"	50500 8 1/4	4,76
8 mm	3/8"	50500 8 3/8	5,38
10 mm	1/4"	50500 10 1/4	5,40
10 mm	3/8"	50500 10 3/8	5,90
12 mm	3/8"	50500 12 3/8	7,50
12 mm	1/2"	50500 12 1/2	9,14

Tornillo orientable simple M BSP cilíndrico/M métrico

Simple banjo bolt M BSP parallel/M metric

Vis pour banjo simple M BSP cil./ M Métrique

Bullone per automatico orientabile



THREAD ROSCA	Part n° Referencia	€
M5	51410 M5	1,51
M6	51410 M6	1,63
M12	51410 M12	2,59
1/8"	51410 1/8	1,97
1/4"	51410 1/4	2,51
3/8"	51410 3/8	3,63

Auto. Pol.-codo intermedio

Push-in Pol.-elbow union

Push-in technopolymère - Coude d'union à piquage

Automatico intermedio a 90



PIPE TUBO	Part n° Referencia	€
4 mm	PUL 04	0,66
6 mm	PUL 06	0,64
8 mm	PUL 08	0,82
10 mm	PUL 10	1,04
12 mm	PUL 12	1,45

Auto. Pol.-codo intermedio cuerpo metálico

Push-in Pol.-elbow union metallic body

Push-in technopolymère - Piquage coude corps métallique

Automatico a 90 intermedio



PIPE TUBO	Part n° Referencia	€
4 mm	50130 4	4,81
6 mm	50130 6	4,88
8 mm	50130 8	5,70
10 mm	50130 10	7,04
12 mm	50130 12	9,23

Auto. Pol.-codo insertable

Push-in Pol.-elbow plug-in

Push-in technopolymère - Coude à piquage lisse

Automatico estremita tubolare



PIPE TUBO	Part n° Referencia	€
4 mm	PLJ 04	1,47
6 mm	PLJ 06	2,00
8 mm	PLJ 08	2,26
10 mm	PLJ 10	2,56
12 mm	PLJ 12	3,50

Auto. Pol.-T intermedio

Push-in Pol.-Tee union

Push-in technopolymère - Piquage en Té

Automatico T intermedio



PIPE TUBO	Part n° Referencia	€
4 mm	PUT 04	0,90
6 mm	PUT 06	0,89
8 mm	PUT 08	1,00
10 mm	PUT 10	1,34
12 mm	PUT 12	1,87

Auto. Pol.-T intermedio cuerpo metálico

Push-in Pol.-Tee union metallic body

Push-in technopolymère - Té à piquage

Automatico a T intermedio



PIPE TUBO	Part n° Referencia	€
4 mm	50230 4	6,59
6 mm	50230 6	6,99
8 mm	50230 8	8,09
10 mm	50230 10	10,51
12 mm	50230 12	13,01

Conexión Push-in automático

Push-in Fittings

Raccords Automatiques Push-in

Raccordi automatici Push-in

Auto. Pol.-Y intermedio

Push-in Pol.-Y union

Push-in technopolymère - Piquage en Y



Automatico intermedio a Y

PIPE TUBO	Part nº Referencia	€
4 mm	PY 04	0,77
6 mm	PY 06	1,04
8 mm	PY 08	1,02
10 mm	PY 10	1,43
12 mm	PY 12	1,83

Auto. Pol.-Y intermedio cuerpo metálico

Push-in Pol.-Y union metallic body

Push-in technopolymère - Piquage en Y



Automatico a Y intermedio

PIPE TUBO	Part nº Referencia	€
4 mm	50310 4	9,14
6 mm	50310 6	9,65
8 mm	50310 8	10,89

Auto. Pol.-Y central insertable

Push-in Pol.-Y central plug-in

Push-in technopolymère - Piquage en Y simple lisse



Automatico a Y estremita tubolare centrale

PIPE TUBO	PIPE TUBO	Part nº Referencia	€
6 mm	4 mm	PWJ 0604	1,68
8 mm	6 mm	PWJ 0806	2,52
10 mm	8 mm	PWJ 1008	2,80
12 mm	10 mm	PWJ 1210	3,99
4 mm	4 mm	PYJ 04	1,90
6 mm	6 mm	PYJ 06	2,07
8 mm	8 mm	PYJ 08	2,56
10 mm	10 mm	PYJ 10	3,13
12 mm	12 mm	PYJ 12	4,04

Auto. Pol.-cruz intermedio

Push-in Pol.-cross union

Push-in technopolymère - Croix à piquage



Automatico intermedio a croce

PIPE TUBO	Part nº Referencia	€
4 mm	PZA 04	1,42
6 mm	PZA 06	1,72
8 mm	PZA 08	1,86
10 mm	PZA 10	2,62
12 mm	PZA 12	3,66

Auto. Pol.-múltiple intermedio

Push-in Pol.-Multiple union

Push-in technopolymère - Piquage multiple



Automatico intermedio con uscite multiple

PIPE TUBO	PIPE TUBO	Part nº Referencia	€
6 mm	4 mm	PKG 0604	2,02
8 mm	4 mm	PKG 0804	2,40
10 mm	6 mm	PKG 1006	3,36
10 mm	8 mm	PKG 1008	3,36

Tapón insertable para automático

Plug-in for push-in

Piquage bouchon



Automatico tappo

PIPE TUBO	Part nº Referencia	€
4 mm	TAP 04	0,34
6 mm	TAP 06	0,44
8 mm	TAP 08	0,50
10 mm	TAP 10	0,55
12 mm	TAP 12	0,78

Conexión Push-in automático

Push-in Fittings

Raccords Automatiques Push-in

Raccordi automatici Push-in

Auto. Met.-M BSPT cónico

Push-in Met.-M BSPT tapered

Push-in métallique - M BSPT conique

Automatico diritto maschio



PIPE TUBO	THREAD ROSCA	Part n° Referencia	€
4 mm	1/8"	MPC 0401	1,90
4 mm	1/4"	MPC 0402	1,97
6 mm	1/8"	MPC 0601	1,93
6 mm	1/4"	MPC 0602	2,18
6 mm	3/8"	MPC 0603	2,69
8 mm	1/8"	MPC 0801	2,20
8 mm	1/4"	MPC 0802	2,13
8 mm	3/8"	MPC 0803	2,75
10 mm	1/8"	MPC 1001	3,17
10 mm	1/4"	MPC 1002	3,33
10 mm	3/8"	MPC 1003	3,48
10 mm	1/2"	MPC 1004	4,94

Auto. Met.-codo giratorio M BSPT cónico

Push-in Met.-elbow adjustable M BSPT tapered

Push-in métallique - Coude orientable M BSPT conique

Automatico maschio girevole



PIPE TUBO	THREAD ROSCA	Part n° Referencia	€
4 mm	1/8"	MPL 0401	3,37
4 mm	1/4"	MPL 0402	3,52
6 mm	1/8"	MPL 0601	4,50
6 mm	1/4"	MPL 0602	4,67
8 mm	1/8"	MPL 0801	5,30
8 mm	1/4"	MPL 0802	5,72
8 mm	3/8"	MPL 0803	5,66
10 mm	1/4"	MPL 1002	6,60
10 mm	3/8"	MPL 1003	7,07
10 mm	1/2"	MPL 1004	8,07

Auto. Met.-M BSP cilíndrico/M métrico c/junta

Push-in Met.-M BSP parallel/M metric w/o'ring

Push-in mét. - Piquage droit mâle BSP cylindrique/ M métrique avec o'ring

Automatico diritto maschio cilindrico con o'ring



PIPE TUBO	THREAD ROSCA	Part n° Referencia	€
4 mm	M5	MPCCI 04M5	1,87
4 mm	1/8"	MPCCI 0401	1,96
4 mm	1/4"	MPCCI 0402	1,97
6 mm	1/8"	MPCCI 0601	2,00
6 mm	1/4"	MPCCI 0602	2,07
6 mm	3/8"	MPCCI 0603	2,69
8 mm	1/8"	MPCCI 0801	2,12
8 mm	1/4"	MPCCI 0802	2,13
8 mm	3/8"	MPCCI 0803	2,75
10 mm	1/4"	MPCCI 1002	3,17
10 mm	3/8"	MPCCI 1003	3,36
10 mm	1/2"	MPCCI 1004	4,71
12 mm	1/4"	MPCCI 1202	3,96
12 mm	3/8"	MPCCI 1203	4,46
12 mm	1/2"	MPCCI 1204	4,73

Auto. Met.-codo orientable M BSP cilíndrico c/junta

Push-in Met.-elbow banjo M BSP parallel w/o'ring

Push-in mét. - Coude orientable M BSP cilindrique avec o'ring

Automatico estremita tubolare a 90 cilindrico con o'ring



PIPE TUBO	THREAD ROSCA	Part n° Referencia	€
6 mm	1/8"	MPHCI 0601	5,30
8 mm	1/4"	MPHCI 0802	7,69
10 mm	1/4"	MPHCI 1002	8,03

Auto. Met.-codo giratorio M BSP cilíndrico/M métrico c/junta

Push-in Met.-elbow adjustable M BSP parallel/M metric w/o'ring

Push-in mét. - Coude orientable M BSP cilindrique / M métrique avec o'ring

Automatico girevole cilindrico con o'ring



PIPE TUBO	THREAD ROSCA	Part n° Referencia	€
4 mm	M5	MPLCI 04M5	3,20
4 mm	1/8"	MPLCI 0401	3,30
4 mm	1/4"	MPLCI 0402	3,52
6 mm	1/8"	MPLCI 0601	4,64
6 mm	1/4"	MPLCI 0602	4,67
6 mm	3/8"	MPLCI 0603	5,01
8 mm	1/8"	MPLCI 0801	5,46
8 mm	1/4"	MPLCI 0802	5,65
8 mm	3/8"	MPLCI 0803	5,90
10 mm	1/4"	MPLCI 1002	6,81
10 mm	3/8"	MPLCI 1003	7,29
12 mm	1/4"	MPLCI 1202	8,34
12 mm	3/8"	MPLCI 1203	8,65
12 mm	1/2"	MPLCI 1204	9,91

Auto. Met.-H BSP cilíndrico

Push-in Met.-F BSP parallel

Push-in mét. - Piquage droit femelle BSP cylindrique

Automatico diritto femmina cilindrico



PIPE TUBO	THREAD ROSCA	Part n° Referencia	€
4 mm	1/8"	MPCF 0401	2,40
6 mm	1/8"	MPCF 0601	2,50
6 mm	1/4"	MPCF 0602	2,69
8 mm	1/8"	MPCF 0801	2,78
8 mm	1/4"	MPCF 0802	2,75
10 mm	1/4"	MPCF 1002	3,28
12 mm	3/8"	MPCF 1203	5,15

Conexión Push-in automático

Push-in Fittings

Raccords Automatiques Push-in

Raccordi automatici Push-in

Auto. Met.-codo microrregulador p/cilindro M BSP cilíndrico c/junta

Push-in Met.-elbow speed controller for cylinder
M BSP parallel w/o ring

Push-in mét. - Microrégulateur pour vérins
cylindrique M BSP cylindrique avec o'ring

Microregolatore cilindrico per cilindro con o'ring



PIPE TUBO	THREAD ROSCA	Part n° Referencia	€
4 mm	1/8"	MSCL 0401	8,95
4 mm	1/4"	MSCL 0402	11,71
6 mm	1/8"	MSCL 0601	8,95
6 mm	1/4"	MSCL 0602	11,71
6 mm	3/8"	MSCL 0603	14,89
8 mm	1/8"	MSCL 0801	8,95
8 mm	1/4"	MSCL 0802	12,91
8 mm	3/8"	MSCL 0803	19,43
10 mm	1/4"	MSCL 1002	12,91

Auto. Met.-T central giratorio M BSP cilíndrico c/junta

Push-in Met.-Tee central adjustable M BSP
parallel w/o ring

Push-in mét. - Té à piquage mâle tournant
central BSP cylindrique avec o'ring

Automatico T maschio girevole centrale cilindrico
con o'ring



PIPE TUBO	THREAD ROSCA	Part n° Referencia	€
4 mm	1/8"	MPTCI 0401	4,67
6 mm	1/8"	MPTCI 0601	5,61
6 mm	1/4"	MPTCI 0602	6,52
8 mm	1/8"	MPTCI 0801	7,64
8 mm	1/4"	MPTCI 0802	7,61
8 mm	3/8"	MPTCI 0803	8,26
10 mm	1/4"	MPTCI 1002	9,27
10 mm	3/8"	MPTCI 1003	9,88
12 mm	3/8"	MPTCI 1203	10,64

Auto. Met.-intermedio

Push-in Met.-union

Push-in métallique - Union à piquage

Automatico intermedio



PIPE TUBO	Part n° Referencia	€
4 mm	MPUC 04	2,52
6 mm	MPUC 06	3,07
8 mm	MPUC 08	3,82
10 mm	MPUC 10	5,55
12 mm	MPUC 12	6,28

Auto. Met.-intermedio pasatabique tuerca métrica

Push-in Met.-union bulkhead w/metric nut

Push-in métallique - Piquage passe-cloison
cylindrique

Automatico intermedio passaparete cilindrico



PIPE TUBO	THREAD ROSCA	Part n° Referencia	€
4 mm	M12X1	MPMM 04	3,83
6 mm	M14X1	MPMM 06	4,77
8 mm	M16X1	MPMM 08	5,70
10 mm	M20X1	MPMM 10	7,39
12 mm	M22X1	MPMM 12	8,59

Auto. Met.-T lateral giratorio M BSP cilíndrico c/junta

Push-in Met.-Tee lateral adjustable M BSP parallel
w/o ring

Push-in mét. - Té à piquage mâle tournant
latéral BSP cylindrique avec o'ring

Automatico T maschio girevole laterale cilindrico
con o'ring



PIPE TUBO	THREAD ROSCA	Part n° Referencia	€
4 mm	1/8"	MPSTCI 0401	4,48
4 mm	1/4"	MPSTCI 0402	4,78
6 mm	1/8"	MPSTCI 0601	6,49
6 mm	1/4"	MPSTCI 0602	6,52
6 mm	3/8"	MPSTCI 0603	6,87
8 mm	1/8"	MPSTCI 0801	7,64
8 mm	1/4"	MPSTCI 0802	7,61
8 mm	3/8"	MPSTCI 0803	8,26
10 mm	1/4"	MPSTCI 1002	9,35

Auto. Met.-codo intermedio

Push-in Met.-elbow union

Push-in technopolymère - Union à piquage

Automatico intermedio a 90



PIPE TUBO	Part n° Referencia	€
4 mm	MPUL 04	2,75
6 mm	MPUL 06	3,03
8 mm	MPUL 08	4,06
10 mm	MPUL 10	5,49

Auto. Met.-T intermedio

Push-in Met.-Tee union

Push-in métallique - Piquage en Té
intermédiaire

Automatico T intermedio



PIPE TUBO	Part n° Referencia	€
4 mm	MPUT 04	3,89
6 mm	MPUT 06	4,68
8 mm	MPUT 08	6,75
10 mm	MPUT 10	8,31
12 mm	MPUT 12	10,21

Conexión Push-in automático

Push-in Fittings

Raccords Automatiques Push-in

Raccordi automatici Push-in

Auto. Met.-Y intermedio

Push-in Met.-Y union

Push-in métallique - Piquage en Y

Automatico intermedio a Y



PIPE TUBO	Part nº Referencia	€
4 mm	MPY 04	4,89
6 mm	MPY 06	5,94
8 mm	MPY 08	7,77
10 mm	MPY 10	10,18
12 mm	MPY 12	11,52

Tapón insertable para automático

Plug-in for Push-in

Piquage bouchon

Automatico tappo



PIPE TUBO	Part nº Referencia	€
4 mm	TAP 04	0,34
6 mm	TAP 06	0,44
8 mm	TAP 08	0,50
10 mm	TAP 10	0,55
12 mm	TAP 12	0,78

Insertable para automático cuerpo metálico M BSP

Plug-in for Push-in M BSP

*Insertable pour adaptateur M BSP cylindrique
corps métallique*

Adattatore maschio cilindrico



PIPE TUBO	THREAD ROSCA	Part nº Referencia	€
4 mm	1/8"	50600 4 1/8	1,57
6 mm	1/8"	50600 6 1/8	1,57
6 mm	1/4"	50600 6 1/4	2,09
8 mm	1/8"	50600 8 1/8	1,67
8 mm	1/4"	50600 8 1/4	2,28
8 mm	3/8"	50600 8 3/8	3,26
10 mm	1/4"	50600 10 1/4	2,36
10 mm	3/8"	50600 10 3/8	3,37
12 mm	1/4"	50600 12 1/4	2,52
12 mm	3/8"	50600 12 3/8	3,50

Conexión con espiga

Hose tail-M BSPT tapered

Raccords avec embout

Raccordi con inserto

Espiga-M BSPT cónico

Hose tail-M BSPT tapered

Douille mâle BSP cylindrique

Inserto maschio cilindrico senza o-ring



PIPE TUBO	THREAD ROSCA	Part nº Referencia	€
6 mm	1/8"	3040 6 1/8	0,87
6 mm	1/4"	3040 6 1/4	1,22
7 mm	1/8"	3040 7 1/8	1,08
7 mm	1/4"	3040 7 1/4	1,23
8 mm	1/8"	3040 8 1/8	1,08
8 mm	1/4"	3040 8 1/4	1,55
9 mm	1/8"	3040 9 1/8	1,15
9 mm	1/4"	3040 9 1/4	1,35
9 mm	3/8"	3040 9 3/8	1,76
9 mm	1/2"	3040 9 1/2	2,68
10 mm	1/4"	3040 10 1/4	1,71
10 mm	3/8"	3040 10 3/8	1,76
10 mm	1/2"	3040 10 1/2	3,07
12 mm	1/4"	3040 12 1/4	1,58
12 mm	3/8"	3040 12 3/8	2,25
12 mm	1/2"	3040 12 1/2	3,01
14 mm	3/8"	3040 14 3/8	2,04
14 mm	1/2"	3040 14 1/2	3,26
16 mm	3/8"	3040 16 3/8	2,45
16 mm	1/2"	3040 16 1/2	3,52

Espiga doble

Doble hose tail connector

Douille double jonction

Inserto doppio



PIPE TUBO	Part nº Referencia	€
6 mm	3055 6	0,52
8 mm	3055 8	0,77
10 mm	3055 10	0,93

Espiga-M BSP cilíndrico C/J

Hose tail-M BSP parallel w.o-ring

Douille mâle BSP cylindrique avec joint

Inserto maschio cilindrico con o-ring



PIPE TUBO	THREAD ROSCA	Part nº Referencia	€
7 mm	1/8"	3045 7 1/8	1,02
7 mm	1/4"	3045 7 1/4	1,41
8 mm	1/8"	3045 8 1/8	1,09
9 mm	1/8"	3045 9 1/8	1,33
9 mm	1/4"	3045 9 1/4	1,57
9 mm	3/8"	3045 9 3/8	2,12
12 mm	1/4"	3045 12 1/4	1,90
12 mm	3/8"	3045 12 3/8	2,28
12 mm	1/2"	3045 12 1/2	3,28

Espiga-H BSP cilíndrico

Hose tail-F BSP parallel

Douille femelle BSP cylindrique

Inserto femmina



PIPE TUBO	THREAD ROSCA	Part nº Referencia	€
6 mm	1/8"	3050 6 1/8	0,99
7 mm	1/8"	3050 7 1/8	1,08
7 mm	1/4"	3050 7 1/4	1,25
8 mm	1/4"	3050 8 1/4	1,46
9 mm	1/4"	3050 9 1/4	1,66
9 mm	3/8"	3050 9 3/8	2,06
10 mm	3/8"	3050 10 3/8	1,95
12 mm	3/8"	3050 12 3/8	2,41
12 mm	1/2"	3050 12 1/2	3,13

Espiga macho cilíndrico sin junta

Male hose adapter parallel without o-ring

Douille mâle cylindrique sans joint

Inserto maschio cilindrico senza giunta



PIPE TUBO	THREAD ROSCA	Part nº Referencia	€
9 mm	3/8"	3045A 9 3/8	2,44
12 mm	1/4"	3045A 12 1/4	2,19
12 mm	1/2"	3045A 12 1/2	4,20

Hasta fin de existencias. / Until end of stock. / Jusqu'à la fin du stock. / Fino ad esaurimento scorta.

Conexión Push-on

Push-on Fittings
Raccords Push-on
Raccordi Push-on

Push-on-M BSPT cónico

Push-on-M BSPT tapered

Raccord droit mâle conique

Raccordo maschio conico



PIPE TUBO	THREAD ROSCA	Part n° Referencia	€
4/2.7 mm	1/8"	1000 4/2.7 1/8	1,80
6/4 mm	1/8"	1000 6/4 1/8	1,58
6/4 mm	1/4"	1000 6/4 1/4	1,88
6/4 mm	3/8"	1000 6/4 3/8	2,74
8/6 mm	1/8"	1000 8/6 1/8	2,10
8/6 mm	1/4"	1000 8/6 1/4	2,00
8/6 mm	3/8"	1000 8/6 3/8	2,82
8/6 mm	1/2"	1000 8/6 1/2 *	4,02
10/8 mm	1/4"	1000 10/8 1/4	2,59
10/8 mm	3/8"	1000 10/8 3/8	3,11
10/8 mm	1/2"	1000 10/8 1/2	4,30
12/10 mm	3/8"	1000 12/10 3/8	3,29
12/10 mm	1/2"	1000 12/10 1/2	4,52

*Hasta fin de existencias. / *Until end of stock. / *Jusqu'à la fin du stock. / *Fino ad esaurimento scorta.

Push-on-giratorio M BSPT cónico

Push-on-adjustable M BSPT tapered

Raccord droit mâle tournant conique

Raccordo maschio conico girevole



PIPE TUBO	THREAD ROSCA	Part n° Referencia	€
6/4 mm	1/8"	1010 6/4 1/8	3,72
6/4 mm	1/4"	1010 6/4 1/4	4,02
8/6 mm	1/8"	1010 8/6 1/8	3,93
8/6 mm	1/4"	1010 8/6 1/4	4,34
10/8 mm	1/4"	1010 10/8 1/4	4,88
12/8 mm	3/8"	1010 12/8 3/8	6,69
12/10 mm	3/8"	1010 12/10 3/8	6,69

Push-on-codo M BSPT cónico

Push-on-elbow M BSPT tapered

Raccord coudé mâle conique

Raccordo a 90 maschio conico



PIPE TUBO	THREAD ROSCA	Part n° Referencia	€
4/2.7 mm	1/8"	1100 4/2.7 1/8	3,31
6/4 mm	1/8"	1100 6/4 1/8	2,45
6/4 mm	1/4"	1100 6/4 1/4	2,59
6/4 mm	3/8"	1100 6/4 3/8	3,48
8/6 mm	1/8"	1100 8/6 1/8	2,62
8/6 mm	1/4"	1100 8/6 1/4	2,89
8/6 mm	3/8"	1100 8/6 3/8	3,28
8/6 mm	1/2"	1100 8/6 1/2	6,25
10/8 mm	1/4"	1100 10/8 1/4	3,51
10/8 mm	3/8"	1100 10/8 3/8	3,98
10/8 mm	1/2"	1100 10/8 1/2	6,10
12/10 mm	3/8"	1100 12/10 3/8	4,93
12/10 mm	1/2"	1100 12/10 1/2	6,69

Push-on-codo giratorio M BSPT cónico

Push-on-elbow adjustable M BSPT tapered

Raccord coudé tournant mâle conique

Raccordo a 90 maschio conico girevole



PIPE TUBO	THREAD ROSCA	Part n° Referencia	€
4/2.7 mm	1/8"	1110 4/2.7 1/8	4,14
6/4 mm	1/8"	1110 6/4 1/8	4,14
6/4 mm	1/4"	1110 6/4 1/4	4,77
8/6 mm	1/8"	1110 8/6 1/8	4,42
8/6 mm	1/4"	1110 8/6 1/4	4,93
10/8 mm	1/4"	1110 10/8 1/4	5,70

Push-on-T central giratorio M BSPT cónico

Push-on-Tee central adjustable M BSPT tapered

Raccord en té avec tournant mâle central

Raccordo a T maschio conico girevole centrale



PIPE TUBO	THREAD ROSCA	Part n° Referencia	€
6/4 mm	1/8"	1210 6/4 1/8	5,70
6/4 mm	1/4"	1210 6/4 1/4	5,90
8/6 mm	1/8"	1210 8/6 1/8	5,70
8/6 mm	1/4"	1210 8/6 1/4	6,20
10/8 mm	1/4"	1210 10/8 1/4	7,70

Push-on-T lateral M BSPT cónico

Push-on-Tee lateral M BSPT tapered

Raccord en té avec mâle conique latéral

Raccordo a Y laterale conico maschio



PIPE TUBO	THREAD ROSCA	Part n° Referencia	€
6/4 mm	1/8"	1220 6/4 1/8	3,60
6/4 mm	1/4"	1220 6/4 1/4	3,78
8/6 mm	1/8"	1220 8/6 1/8	4,02
8/6 mm	1/4"	1220 8/6 1/4	4,25
10/8 mm	1/4"	1220 10/8 1/4	5,38
10/8 mm	3/8"	1220 10/8 3/8	6,32
12/10 mm	3/8"	1220 12/10 3/8	7,73

Conexión Push-on

Push-on Fittings
Raccords Push-on
Raccordi Push-on

Push-on-M BSP cilíndrico/M métrico c/junta

Push-on-M BSP/M metric w/o'ring parallel

Raccord droit mâle cylindrique avec o'ring

Raccordo maschio cilindrico con o-ring



PIPE TUBO	THREAD ROSCA	Part n° Referencia	€
4/2.7 mm	1/8"	1020 4/2.7 1/8	1,80
6/4 mm	1/8"	1020 6/4 1/8	2,03
6/4 mm	1/4"	1020 6/4 1/4	2,57
6/4 mm	3/8"	1020 6/4 3/8	3,24
6/4 mm	1/2"	1020 6/4 1/2	5,04
8/6 mm	1/8"	1020 8/6 1/8	2,27
8/6 mm	1/4"	1020 8/6 1/4	2,33
8/6 mm	3/8"	1020 8/6 3/8	3,21
8/6 mm	1/2"	1020 8/6 1/2	4,93
10/8 mm	1/4"	1020 10/8 1/4	3,01
10/8 mm	3/8"	1020 10/8 3/8	3,41
10/8 mm	1/2"	1020 10/8 1/2	5,43
12/10 mm	3/8"	1020 12/10 3/8	3,87
12/10 mm	1/2"	1020 12/10 1/2	5,93
6/4 mm	M5	1021 6/4 M5	1,68
6/4 mm	M6	1021 6/4 M6	1,68

Push-on-H BSP cilíndrico

Push-on-F BSP parallel

Raccord droit femelle

Raccordo femmina



PIPE TUBO	THREAD ROSCA	Part n° Referencia	€
6/4 mm	1/8"	1030 6/4 1/8	2,10
6/4 mm	1/4"	1030 6/4 1/4	2,33
6/4 mm	3/8"	1030 6/4 3/8	3,70
8/6 mm	1/8"	1030 8/6 1/8	2,12
8/6 mm	1/4"	1030 8/6 1/4	2,57
8/6 mm	3/8"	1030 8/6 3/8	3,80
8/6 mm	1/2"	1030 8/6 1/2	3,99
10/8 mm	1/4"	1030 10/8 1/4	2,89
10/8 mm	3/8"	1030 10/8 3/8	3,98
10/8 mm	1/2"	1030 10/8 1/2	5,04
12/10 mm	3/8"	1030 12/10 3/8	5,70

Push-on-codo giratorio M BSP cilíndrico c/junta

Push-on-elbow adjustable M BSP parallel w/o'ring

Raccord coudé tournant mâle cylindrique avec o'ring

Raccordo a 90 maschio girevole con o'ring



PIPE TUBO	THREAD ROSCA	Part n° Referencia	€
4/2.7 mm	1/8"	1115 4/2.7 1/8	4,14
6/4 mm	1/4"	1115 6/4 1/4	4,77
8/6 mm	1/8"	1115 8/6 1/8	4,42
8/6 mm	1/4"	1115 8/6 1/4	4,93
10/8 mm	1/4"	1115 10/8 1/4	5,70

Push-on-codo H BSP cilíndrico

Push-on-elbow F BSP parallel

Raccord coudé femelle

Raccordo a 90 femmina fissa



PIPE TUBO	THREAD ROSCA	Part n° Referencia	€
6/4 mm	1/8"	1120 6/4 1/8	2,81
6/4 mm	1/4"	1120 6/4 1/4	3,40
8/6 mm	1/8"	1120 8/6 1/8	3,08
8/6 mm	1/4"	1120 8/6 1/4	3,70
10/8 mm	1/4"	1120 10/8 1/4	4,14
10/8 mm	3/8"	1120 10/8 3/8	7,14

Push-on-T central giratorio M BSP cilíndrico c/junta

Push-on-Tee central adjustable M BSP parallel w/o'ring

Raccord en té avec tournant mâle central avec o'ring

Raccordo a T maschio girevole centrale con o'ring



PIPE TUBO	THREAD ROSCA	Part n° Referencia	€
6/4 mm	1/8"	1215 6/4 1/8	5,97
6/4 mm	1/4"	1215 6/4 1/4	6,17
8/6 mm	1/8"	1215 8/6 1/8	5,97
8/6 mm	1/4"	1215 8/6 1/4	6,56
10/8 mm	1/4"	1215 10/8 1/4	8,12

Tuerca para push-on rosca métrica

Nut for Push-on metric thread

Vis de fixation

Dado di fissaggio



PIPE TUBO	THREAD ROSCA	Part n° Referencia	€
4/2.7 mm	M6X0,5	1700 4/2.7	0,54
6/4 mm	M10X1	1700 6/4	0,56
8/6 mm	M12x1	1700 8/6	0,69
10/8 mm	M14X1	1700 10/8	0,91
12/10 mm	M16X1	1700 12/10	1,21

Push-on-intermedio

Push-on-Union

Raccord intermédiaire

Raccordo intermedio



PIPE TUBO	PIPE TUBO	Part n° Referencia	€
4/2.7 mm	4/2.7 mm	1040 4/2.7	3,13
6/4 mm	6/4 mm	1040 6/4	2,89
8/6 mm	6/4 mm	1040 8/6 6/4	3,16
8/6 mm	8/6 mm	1040 8/6	3,12
10/8 mm	6/4 mm	1040 10/8 6/4	4,30
10/8 mm	8/6 mm	1040 10/8 8/6	4,52
10/8 mm	10/8 mm	1040 10/8	4,25
12/10 mm	12/10 mm	1040 12/10	6,88

Conexión Push-on

Push-on Fittings
Raccords Push-on
Raccordi Push-on

Push-on-intermedio pasatabique c/tuerca métrica

Push-on-Union bulkhead w/metric nut

Raccord passe-cloison

Raccordo passaparete



PIPE TUBO		THREAD ROSCA	Part n° Referencia	€
4/2.7 mm	4/2.7 mm	M6x0,5	1050 4/2.7	4,81
6/4 mm	6/4 mm	M10x1	1050 6/4	4,96
8/6 mm	6/4 mm	M12x1	1050 8/6X6/4	5,73
8/6 mm	8/6 mm	M12x1	1050 8/6	5,73
10/8 mm	6/4 mm	M14x1	1050 10/8X6/4	6,84
10/8 mm	8/6 mm	M14x1	1050 10/8X8/6	6,84
10/8 mm	10/8 mm	M14x1	1050 10/8	6,49
12/10 mm	12/10 mm	M16x1	1050 12/10	7,55

Push-on-cuerpo orientable

Push-on-Banjo body

Banjo simple

Occhio orientabile semplice



PIPE TUBO	THREAD ROSCA	Part n° Referencia	€
4/2.7 mm	1/8"	1500 4/2.7 1/8	2,93
6/4 mm	1/8"	1500 6/4 1/8	3,21
6/4 mm	1/4"	1500 6/4 1/4	3,28
6/4 mm	3/8"	1500 6/4 3/8	4,17
6/4 mm	M6	1500 6/4 M6	2,62
8/6 mm	1/8"	1500 8/6 1/8	3,28
8/6 mm	1/4"	1500 8/6 1/4	3,41
8/6 mm	3/8"	1500 8/6 3/8	4,42
8/6 mm	1/2"	1500 8/6 1/2	5,70
10/8 mm	1/8"	1500 10/8 1/8	3,48
10/8 mm	1/4"	1500 10/8 1/4	3,75
10/8 mm	3/8"	1500 10/8 3/8	4,72
10/8 mm	1/2"	1500 10/8 1/2	5,97
12/10 mm	3/8"	1500 12/10 3/8	5,55
12/10 mm	1/2"	1500 12/10 1/2	6,91

Push-on doble-Cuerpo orientable

Dual Push-on-Banjo body

Banjo double

Occhio orientabile doppio



PIPE TUBO	THREAD ROSCA	Part n° Referencia	€
4/2.7 mm	1/8"	1510 4/2.7 1/8	5,35
6/4 mm	1/8"	1510 6/4 1/8	5,38
6/4 mm	1/4"	1510 6/4 1/4	5,78
6/4 mm	3/8"	1510 6/4 3/8	6,69
8/6 mm	1/8"	1510 8/6 1/8	5,63
8/6 mm	1/4"	1510 8/6 1/4	5,63
8/6 mm	3/8"	1510 8/6 3/8	6,69
8/6 mm	1/2"	1510 8/6 1/2	8,12
10/8 mm	1/8"	1510 10/8 1/8	6,17
10/8 mm	1/4"	1510 10/8 1/4	6,25
10/8 mm	3/8"	1510 10/8 3/8	7,11
10/8 mm	1/2"	1510 10/8 1/2	8,52
12/10 mm	3/8"	1510 12/10 3/8	8,24
12/10 mm	1/2"	1510 12/10 1/2	9,57

Tornillo orientable simple M BSP cilíndrico/M métrico

Simple banjo bolt M BSP parallel/M metric

Vis pour banjo simple

Bullone forato singolo



THREAD ROSCA	Part n° Referencia	€
M5	51410 M5	1,51
M6	51410 M6	1,63
M12	51410 M12	2,59
1/8"	51410 1/8	1,97
1/4"	51410 1/4	2,51
3/8"	51410 3/8	3,63

Tornillo orientable doble M BSP cilíndrico

Double banjo bolt M BSP parallel

Vis pour banjo double

Bullone forato doppio



THREAD ROSCA	Part n° Referencia	€
1/8"	51420 1/8	2,74
1/4"	51420 1/4	3,93
3/8"	51420 3/8	5,93
1/2"	51420 1/2	6,25

Push-on-codo intermedio

Push-on-elbow union

Raccord coudé intermédiaire

Raccordo a 90 intermedio



PIPE TUBO		Part n° Referencia	€
4/2.7 mm	4/2.7 mm	1130 4/2.7	4,49
6/4 mm	6/4 mm	1130 6/4	3,31
8/6 mm	6/4 mm	1130 8/6 6/4	3,63
8/6 mm	8/6 mm	1130 8/6	3,70
10/8 mm	10/8 mm	1130 10/8	4,69
12/10 mm	12/10 mm	1130 12/10	6,32

Push-on-T intermedio

Push-on-Tee union

Raccord en té intermédiaire

Raccordo a T intermedio



PIPE TUBO	Part n° Referencia	€
4/2.7 mm	1230 4/2.7	5,01
6/4 mm	1230 6/4	4,30
8/6 mm	1230 8/6	4,77
10/8 mm	1230 10/8	6,25
12/10 mm	1230 12/10	8,67

Conexión Push-on

Push-on Fittings
Raccords Push-on
Raccordi Push-on

Push-on-cruz intermedio

Push-on-cross union

Raccord en croix intermédiaire

Raccordo a croce intermedio



PIPE TUBO	Part n° Referencia	€
6/4 mm	1300 6/4	7,03
8/6 mm	1300 8/6	8,09
10/8 mm	1300 10/8	10,12
12/10 mm	1300 12/10	14,46

Push-on c/muelle-M BSPT cónico

Push-on w/nut+spring-M BSPT tapered

Raccord droit mâle conique avec ressort

Raccordo maschio conico+molla



PIPE TUBO	THREAD ROSCA	Part n° Referencia	€
6/4 mm	1/8"	1025 6/4 1/8	3,31
6/4 mm	1/4"	1025 6/4 1/4	3,56
8/6 mm	1/8"	1025 8/6 1/8	3,48
8/6 mm	1/4"	1025 8/6 1/4	3,60
8/6 mm	3/8"	1025 8/6 3/8	4,17
8/6 mm	1/2"	1025 8/6 1/2	5,43
10/8 mm	1/8"	1025 10/8 1/8	4,07
10/8 mm	1/4"	1025 10/8 1/4	4,10
10/8 mm	3/8"	1025 10/8 3/8	4,76
10/8 mm	1/2"	1025 10/8 1/2	5,98
12/10 mm	3/8"	1025 12/10 3/8	5,58
12/10 mm	1/2"	1025 12/10 1/2	6,69

Push-on c/muelle-M BSP cilíndrico c/junta

Push-on w/nut+spring-M BSP w/o'ring parallel

Raccord droit mâle cylindrique avec ressort

Raccordo maschio +molla



PIPE TUBO	THREAD ROSCA	Part n° Referencia	€
6/4 mm	1/8"	1028 6/4 1/8	3,41
6/4 mm	1/4"	1028 6/4 1/4	3,93
6/4 mm	3/8"	1028 6/4 3/8	4,34
6/4 mm	1/2"	1028 6/4 1/2	5,73
8/6 mm	1/8"	1028 8/6 1/8	3,56
8/6 mm	1/4"	1028 8/6 1/4	3,93
8/6 mm	3/8"	1028 8/6 3/8	4,42
8/6 mm	1/2"	1028 8/6 1/2	5,60
10/8 mm	1/4"	1028 10/8 1/4	4,49
10/8 mm	3/8"	1028 10/8 3/8	4,88
10/8 mm	1/2"	1028 10/8 1/2	6,10
12/10 mm	3/8"	1028 12/10 3/8	6,25
12/10 mm	1/2"	1028 12/10 1/2	7,67

Push-on c/muelle-giratorio M BSP cilíndrico c/junta

Push-on w/nut+spring-adjustable M BSP
w/o'ring parallel

Raccord droit tournant mâle cylindrique avec
ressort

Raccordo maschio cilindrico girevole con molla



PIPE TUBO	THREAD ROSCA	Part n° Referencia	€
6/4 mm	1/8"	1027 6/4 1/8	5,04
6/4 mm	1/4"	1027 6/4 1/4	5,46
8/6 mm	1/4"	1027 8/6 1/8	5,14
8/6 mm	1/4"	1027 8/6 1/4	5,60
10/8 mm	1/4"	1027 10/8 1/4	6,32
12/10 mm	3/8"	1027 12/10 3/8	8,20

Push-on c/muelle-H BSP cilíndrico

Push-on w/nut+spring-F BSP parallel

Raccord droit femelle avec ressort

Raccordo femmina+molla



PIPE TUBO	THREAD ROSCA	Part n° Referencia	€
6/4 mm	1/8"	1035 6/4 1/8	3,51
6/4 mm	1/4"	1035 6/4 1/4	3,95
6/4 mm	3/8"	1035 6/4 3/8	4,96
8/6 mm	1/8"	1035 8/6 1/8	3,70
8/6 mm	1/4"	1035 8/6 1/4	4,30
8/6 mm	3/8"	1035 8/6 3/8	5,43
8/6 mm	1/2"	1035 8/6 1/2	6,10
10/8 mm	1/4"	1035 10/8 1/4	4,84
10/8 mm	3/8"	1035 10/8 3/8	5,63
10/8 mm	1/2"	1035 10/8 1/2	6,44
12/10 mm	3/8"	1035 12/10 3/8	6,91

Push-on c/muelle-Tuerca de fijación métrica

Push-on w/nut+spring-fixing nut F Métrica
parallel

Vis de fixation avec ressort

Dado di fissaggio con molla



PIPE TUBO	THREAD ROSCA	Part n° Referencia	€
6/4 mm	M10x1	1710 6/4	2,22
8/6 mm	M12x1	1710 8/6	2,51
10/8 mm	M14x1	1710 10/8	2,72
12/10 mm	M16x1	1710 12/10	3,78

Adaptador

Adaptors
Adaptateurs
Adattatori

Adaptador M BSPT cónico

Adaptor M BSPT tapered

Adapteur mâle BSPT conique

Maschio conico BSPT



THREAD ROSCA	Part nº Referencia	€
1/8"	2000 1/8	0,86
1/4"	2000 1/4	1,29
3/8"	2000 3/8	1,77
1/2"	2000 1/2	2,99
3/4"	2000 3/4	5,36
1"	2000 1	8,36

Tapón reductor M BSPT cónico-H BSP cilíndrica

Reducer M BSPT tapered-F BSP parallel

Bouchon reducteur mâle BSPT conique- femelle
BSP cilíndrica

Tappo di riduzione M BSPT - F BSP



THREAD ROSCA	Part nº Referencia	€
1/4" 1/8"	2080 1/4 1/8	0,80
3/8" 1/8"	2080 3/8 1/8	1,45
3/8" 1/4"	2080 3/8 1/4	1,36
1/2" 1/4"	2080 1/2 1/8	2,59
1/2" 1/4"	2080 1/2 1/4	2,21
1/2" 3/8"	2080 1/2 3/8	1,89
3/4" 3/8"	2080 3/4 3/8	4,74
3/4" 1/2"	2080 3/4 1/2	3,45

Reductor M BSPT cónico

Reducer M BSPT tapered

Réducteur mâle BSPT conique

Riduzione Maschio BSPT



THREAD ROSCA	Part nº Referencia	€
1/8" 1/4"	2020 1/8-1/4	1,10
1/8" 3/8"	2020 1/8 3/8	1,65
1/8" 1/2"	2020 1/8 1/2	3,14
1/4" 1/2"	2020 1/4 1/2	2,87
1/4" 3/8"	2020 1/4-3/8	1,73
3/8" 1/2"	2020 3/8-1/2	2,47
1/2" 3/4"	2020 1/2 3/4	5,25

Prolongador M BSPT cónico - H BSP cilíndrico

Extensor M BSPT tapered - F BSP parallel

Prolongateur mâle BSPT conique - femelle BSP
cylíndrica

Prolunga M BSPT - F BSP



THREAD ROSCA	Part nº Referencia	€
1/8" 1/8"	2040 1/8 1/8	1,11
1/8" 1/4"	2040 1/8 1/4	1,48
1/8" 3/8"	2040 1/8 3/8	2,00
1/4" 1/4"	2040 1/4 1/4	1,66
1/4" 3/8"	2040 1/4 3/8	2,59
1/4" 1/2"	2040 1/4 1/2	3,17
3/8" 3/8"	2040 3/8 3/8	2,36
3/8" 1/2"	2040 3/8 1/2	3,25
1/2" 3/8"	2040 1/2 3/8	2,43
1/2" 1/2"	2040 1/2 1/2	3,65
1/2" 3/4"	2040 1/2 3/4	6,96

Prolongador pasatabique rosca M métrico-H BSP cilíndrica/métrica

Extensor bulkhead w/metric M - F BSP parallel/
metric

Prolongateur passe-doisson filetage métrique
Mâle.-Fem. BSP cilíndrica/métrica

Prolunga Passaparete M - F BSP/metrica cil.



THREAD ROSCA	Part nº Referencia	€
M10x1 M5	3060 M5	1,65
M16x1,5 1/8"	3060 1/8	3,23
M14x1,5 1/8"	3060 1/8 M14	3,49
M20x1,5 1/4"	3060 1/4	5,25
M26x1,5 3/8"	3060 3/8	8,51
M28x15 1/2"	3060 1/2	10,39

Adaptador M BSP cilíndrico

Adaptor M BSP parallel

Adapteur mâle BSP cylíndrica

Addattatori cilíndrico M BSP



THREAD ROSCA	Part nº Referencia	€
1/8"	2010 1/8	0,97
1/4"	2010 1/4	1,19
3/8"	2010 3/8	2,10
1/2"	2010 1/2	3,20
3/4"	2010 3/4	4,52
1"	2010 1	6,96

Adaptador

Adaptors
Adaptateurs
Adattatori

Reductor M métrico/M BSP cilíndrico

Reducer M BSP parallel / M metric

Réducteur mâle métrique-mâle BSP cylindrique

Maschio cilindrico di riduzione



THREAD ROSCA		Part nº Referencia	€
M5	1/8"	2030 M5 1/8	0,82
1/8"	1/4"	2030 1/8 1/4	1,29
1/8"	3/8"	2030 1/8 3/8	1,65
1/4"	3/8"	2030 1/4 3/8	1,70
1/4"	1/2"	2030 1/4 1/2	2,75
3/8"	1/2"	2030 3/8 1/2	2,79
1/2"	3/4"	2030 1/2 3/4	4,57

Prolongador M BSP cilíndrico/Métrico - H BSP cilíndrica

Extensor M BSP Parallel/M metric - F BSP parallel

Prolongateur mâle BSP cylindrique/métrique
-fem. BSP cylindrique

Prolunga cilindrica standard



THREAD ROSCA		Part nº Referencia	€
M5	1/8"	2050 M5 1/8	1,06
1/8"	1/8"	2050 1/8 1/8	0,93
1/8"	1/4"	2050 1/8 1/4	1,40
1/4"	1/4"	2050 1/4 1/4	1,58
1/4"	3/8"	2050 1/4 3/8	2,32
3/8"	3/8"	2050 3/8 3/8	2,71
3/8"	1/2"	2050 3/8 1/2	3,42
1/2"	1/2"	2050 1/2 1/2	4,52

Prolongador extra M-H BSP cilíndrico

Extra extensor M-F BSP parallel

Prolongateur extra mâle -fem. BSP cylindrique

Prolunga cilindrica



THREAD ROSCA		Part nº Referencia	€
1/8"	1/8"	2070 1/8 1/8 22	1,17
1/8"	1/8"	2070 1/8 1/8 42	2,12
1/4"	1/4"	2070 1/4 1/4 35	2,64
1/4"	1/4"	2070 1/4 1/4 51	3,36

Adaptador H BSP cilíndrico

Adaptor F BSP parallel

Manchon femelle BSP cylindrique

Prolunga femmina



THREAD ROSCA		Part nº Referencia	€
1/8"		3000 1/8	0,99
1/4"		3000 1/4	1,65
3/8"		3000 3/8	2,30
1/2"		3000 1/2	4,29
3/4"		3000 3/4	6,96

Tapón reductor M BSP cilíndrico/Métrico-H BSP cilíndrico

Reducer M BSP parallel - F BSP parallel

Bouchon réducteur mâle BSP cylindrique/
métrique - fem. BSP cylindrique

Tappo di riduzione cilindrico



THREAD ROSCA		Part nº Referencia	€
1/8"	M5	2090 1/8 M5	0,77
1/4"	1/8"	2090 1/4 1/8	0,95
3/8"	1/8"	2090 3/8 1/8	1,58
3/8"	1/4"	2090 3/8 1/4	1,11
1/2"	1/4"	2090 1/2 1/4	2,06
1/2"	3/8"	2090 1/2 3/8	2,01
3/4"	1/2"	2090 3/4 1/2	3,41

Reductor H BSP cilíndrico

Reducer F BSP parallel

Réducteur femelle BSP cylindrique

Prolunga femmina di riduzione



THREAD ROSCA		Part nº Referencia	€
1/8"	1/4"	3010 1/8 1/4	1,14
1/8"	3/8"	3010 1/8 3/8	1,63
1/4"	3/8"	3010 1/4 3/8	2,03
1/4"	1/2"	3010 1/4 1/2	2,31
3/8"	1/2"	3010 3/8 1/2	3,00
1/2"	3/4"	3010 1/2 3/4	4,62

Orientable H BSP cilíndrico

Banjo F BSP parallel

Banjo femelle BSP cylindrique

Occhio filettato femmina



THREAD ROSCA		Part nº Referencia	€
1/8"		6090 1/8	2,62
1/4"		6090 1/4	3,31
3/8"		6090 3/8	4,57

Tornillo orientable simple M BSP cilíndrico/M métrico

Simple banjo bolt M BSP parallel/M metric

Vis pour banjo simple mâle BSP cylindrique /
mâle métrique

Bullone banjo semplice



THREAD ROSCA		Part nº Referencia	€
M5		51410 M5	1,51
M6		51410 M6	1,63
M12		51410 M12	2,59
1/8"		51410 1/8	1,97
1/4"		51410 1/4	2,51
3/8"		51410 3/8	3,63

Adaptador

Adaptors
Adaptateurs
Adattatori

Tornillo orientable doble M BSP cilíndrico

Double banjo bolt M BSP parallel

Vis pour banjo double mâle BSP cylindrique

Bullone forato doppio



THREAD ROSCA	Part nº Referencia	€
1/8"	51420 1/8	2,74
1/4"	51420 1/4	3,93
3/8"	51420 3/8	5,93
1/2"	51420 1/2	6,25

Tapón allen interior M BSPT cónico

Internal Allen plug M BSPT tapered

Bouchon mâle BSPT conique Allen intérieur

Tappo maschio conico Allen



THREAD ROSCA	Part nº Referencia	€
1/8"	3025 1/8	0,55
1/4"	3025 1/4	0,85
3/8"	3025 3/8	1,18
1/2"	3025 1/2	1,92

Tapón M BSPT cónico

Plug M BSPT tapered

Bouchon mâle BSPT conique

Tappo maschio conico



THREAD ROSCA	Part nº Referencia	€
1/8"	3021 1/8	1,53
1/4"	3021 1/4	1,70
3/8"	3021 3/8	1,92
1/2"	3021 1/2	3,89

Tapón allen M BSP cilíndrico c/junta

Allen plug M BSP parallel w/o-ring

Bouchon mâle BSP cylindrique Allen avec o-ring

Tappo maschio cilindrico Allen con o-ring



THREAD ROSCA	Part nº Referencia	€
1/8"	3015 1/8	0,77
1/4"	3015 1/4	1,14
3/8"	3015 3/8	1,58
1/2"	3015 1/2	2,76

Tapón M BSP cilíndrico

Plug M BSP parallel

Bouchon mâle BSP cylindrique

Tappo maschio cilindrico



THREAD ROSCA	Part nº Referencia	€
1/8"	3020 1/8	0,79
1/4"	3020 1/4	1,03
3/8"	3020 3/8	1,57
1/2"	3020 1/2	2,39
3/4"	3020 3/4	4,57

Tapón H BSP cilíndrico

Cap F BSP parallel

Bouchon femelle BSP cylindrique

Tappo femmina



THREAD ROSCA	Part nº Referencia	€
1/8"	3030 1/8	0,87
1/4"	3030 1/4	1,18
3/8"	3030 3/8	2,27
1/2"	3030 1/2	4,12

Adaptador

Adaptors
Adaptateurs
Adattatori

Codo M BSPT cónico

Elbow M BSPT tapered

Raccord coudé mâle BSPT conique

Adattore a 90 maschio conico



THREAD ROSCA	Part nº Referencia	€
1/8"	5000 1/8	1,45
1/4"	5000 1/4	2,47
3/8"	5000 3/8	3,55
1/2"	5000 1/2	5,34
3/4"	5000 3/4	7,34

Codo H BSP cilíndrico

Elbow F BSP parallel

Raccord coudé femelle BSP cylindrique

Adattatore a 90 femmina



THREAD ROSCA	Part nº Referencia	€
1/8"	5010 1/8	2,05
1/4"	5010 1/4	2,85
3/8"	5010 3/8	3,84
1/2"	5010 1/2	6,48
3/4"	5010 3/4	10,37

Codo M BSPT cónico-H BSP cilíndrico

Elbow M BSPT tapered-F BSP

Raccord coudé mâle BSPT conique -femelle BSP cylindrique

Adattatore maschio conico-femmina



THREAD ROSCA	Part nº Referencia	€
1/8" 1/8"	5020 1/8	1,70
1/4" 1/4"	5020 1/4	2,66
3/8" 3/8"	5020 3/8	4,04
1/2" 1/2"	5020 1/2	6,48
3/4" 3/4"	5020 3/4	8,87

T M BSPT cónico

Tee M BSPT tapered

Raccord en té mâle BSPT conique

Adattatore a T maschio conico



THREAD ROSCA	Part nº Referencia	€
1/8" 1/8"	4010 1/8	2,01
1/4" 1/4"	4010 1/4	3,56
3/8" 3/8"	4010 3/8	5,47
1/2" 1/2"	4010 1/2	7,75
3/4" 3/4"	4010 3/4	10,37

T lateral H BSP-H BSP-M BSPT cónico

Tee lateral F BSP -F BSP -M BSPT tapered

Raccord en té latéral femelle BSP - femelle BSP-M BSPT conique

Adattatore a T maschio conico laterale



THREAD ROSCA	Part nº Referencia	€
1/8" 1/8"	4050 1/8	2,91
1/4" 1/4"	4050 1/4	4,19
3/8" 3/8"	4050 3/8	5,47
1/2" 1/2"	4050 1/2	8,99
3/4" 3/4"	4050 3/4	13,03

T central H BSP-M BSPT cónico-H BSP

Tee central F BSP -M BSPT -F BSP tapered

Raccord en té central femelle BSP - M BSPT conique - femelle BSP

Adattatore a T maschio conico centrale



THREAD ROSCA	Part nº Referencia	€
1/8" 1/8"	4040 1/8	2,35
1/4" 1/4"	4040 1/4	3,90
3/8" 3/8"	4040 3/8	5,47
1/2" 1/2"	4040 1/2	10,07
3/4" 3/4"	4040 3/4	11,79

T H BSP cilíndrico

Tee F BSP parallel

Raccord en té femelle BSP cylindrique

Adattatore a T femmina



THREAD ROSCA	Part nº Referencia	€
1/8" 1/8"	4000 1/8	2,72
1/4" 1/4"	4000 1/4	3,93
3/8" 3/8"	4000 3/8	5,74
1/2" 1/2"	4000 1/2	9,37
3/4" 3/4"	4000 3/4	10,37

Adaptador

Adaptors
Adaptateurs
Adattatori

Y central H BSP cilíndrico-M BSPT cónico-H BSP cilíndrico

Y central F BSP -M BSPT -F BSP

Raccord en Y central femelle BSP cylindrique -
mâle BSPT conique-femelle BSP cylindrique

Adattore a Y maschio



THREAD ROSCA		Part n° Referencia	€
1/8"	1/8"	6000 1/8	3,71
1/4"	1/4"	6000 1/4	3,25
3/8"	3/8"	6000 3/8	3,91
1/2"	1/2"	6000 1/2	11,57

Cruz M BSPT cónico

Cross M BSPT tapered

Raccord en croix mâle BSPT conique

Croce maschio



THREAD ROSCA	Part n° Referencia	€
1/8"	6030 1/8	2,02
1/4"	6030 1/4	3,78
3/8"	6030 3/8	6,05
1/2"	6030 1/2	8,32

Cruz en taco H BSP cilíndrico

Cross in block F BSP parallel

Nourrices de distribution en croix taraudée

Croce in blocco



THREAD ROSCA	Part n° Referencia	€
1/8"	6040 1/8	4,99
1/4"	6040 1/4	7,83
3/8"	6040 3/8	11,92
1/2"	6040 1/2	14,02

Cruz H BSP cilíndrico

Cross F BSP parallel

Raccord en croix femelle BSP cylindrique

Croce femmina



THREAD ROSCA	Part n° Referencia	€
1/8"	6020 1/8	4,64
1/4"	6020 1/4	4,84
3/8"	6020 3/8	9,25
1/2"	6020 1/2	15,80

Regleta lateral en taco H BSP cilíndrico

Distribution manifold-F BSP parallel

Nourrices de distribution taraudée

Blocco a multiuscite



THREAD ROSCA		EXITS NR. N° DE SALIDAS	Part n° Referencia	€
1/4"	1/8"	2	6047 1/4 1/8 2	14,29
1/4"	1/8"	3	6047 1/4 1/8 3	19,58
1/4"	1/8"	4	6047 1/4 1/8 4	25,42
1/4"	1/8"	5	6047 1/4 1/8 5	32,59
1/4"	1/8"	6	6047 1/4 1/8 6	38,26
3/8"	1/4"	2	6047 3/8 1/4 2	17,00
3/8"	1/4"	3	6047 3/8 1/4 3	20,86
3/8"	1/4"	4	6047 3/8 1/4 4	27,58
3/8"	1/4"	5	6047 3/8 1/4 5	34,29
3/8"	1/4"	6	6047 3/8 1/4 6	41,32
1/2"	3/8"	2	6047 1/2 3/8 2	21,18
1/2"	3/8"	3	6047 1/2 3/8 3	25,35
1/2"	3/8"	4	6047 1/2 3/8 4	31,91
1/2"	3/8"	5	6047 1/2 3/8 5	37,45
1/2"	3/8"	6	6047 1/2 3/8 6	43,91

Enchufes rápidos neumáticos

Quick release pneumatic couplings

Coupleurs pneumatiques

Innesti rapidi

Enchufes mini - serie mignon

Mini-serie mignon

Coupleurs mini - série mignon

Innesti mini-serie mignon

412

Enchufes mini - serie uni ISO 6150 B-12

Mini-serie uni ISO 6150 B-12

Coupleurs mini - série uni ISO 6150 B-12

Innesti Mini-serie uni ISO 6150 B-12

413

Enchufes mini - serie multipresa

Mini-serie multipress

Coupleurs mini - série multiprise

Innesti Mini-serie uni Multipresa

414

Enchufes rápidos ESTO

Quick release couplings "ESTO"

Coupleurs rapides type ESTO

Innesti rapidi tipo ESTO

415

3

Enchufes mini - serie mignon

Mini-serie mignon

Coupleurs mini - série mignon

Innesti mini- serie mignon

■ Roscados /Screw /Fileté /Filetati

| 412



111



211



112



212

■ Con espiga /With hose tail /Avec embout /Con adattatori

| 412



115



215

■ Push-on /Push-on /Push-on /Push-on

| 412



114



214



113



213

Enchufes mini - serie uni ISO 6150 B-12

Mini-serie uni ISO 6150 B-12

Coupleurs mini - série uni ISO 6150 B-12

Innesti Mini-serie uni ISO 6150 B-12

■ Roscados /Screwed /Fileté /Filetati

| 413



121



221



122



222

■ Con espiga /With hose tail /Avec embout /Con adattatori

| 413



125



225

■ Push-on /Push-on /Push-on /Push-on

| 413



223

Enchufes mini - serie multipresa

Mini-serie multipress
Coupleurs mini - série multiprise
Innesti Mini-serie uni Multipresa

- Roscado / Screw / Fileté / Filetati

| 414



191



192

- Con espiga / With hose tail / Avec embout / Con adattatori

| 414



195

- Push-on / Push-on / Push-on / Push-on

| 414



194



193

Enchufes rápidos ESTO

Quick release couplings "ESTO"
Coupleurs rapides type ESTO
Innesti rapidi tipo ESTO

- Enchufes 1/4 / Quick couplings 1/4 / Coupleurs 1/4 / Innesto 1/4

| 415



ESTO 1



ESTO 1



ESTO 1

- Enchufes 3/8 / Quick couplings 3/8 / Coupleurs 3/8 / Innesto 3/8

| 415



ESTO 3



ESTO 3

- Enchufes 1/2 / Quick couplings 1/2 / Coupleurs 1/2 / Innesto 1/2

| 415



ESTO 2



ESTO 2

Enchufes mini - serie mignon

Mini-serie mignon

Coupleurs mini - série mignon

Innesti mini- serie mignon

Enchufe Mignon hembra-M BSP cilíndrico

Coupling Mignon female - M BSP parallel

Coupleur femelle à mâle- série mignon

Innesto femmina a fileto mascho-serie mignon



THREAD ROSCA	Part nº Referencia	€
1/8	111 1/8	5,74
1/4	111 1/4	6,96
3/8	111 3/8	6,94

Enchufe Mignon macho-M BSP cilíndrico

Coupling Mignon male - M BSP parallel

Coupleur mâle à mâle- série mignon

Innesto mascho a fileto mascho-serie mignon



THREAD ROSCA	Part nº Referencia	€
1/8	211 1/8	1,39
1/4	211 1/4	1,87
3/8	211 3/8	2,30

Enchufe Mignon hembra-espiga

Coupling Mignon female-hose tail

Coupleur femelle à douille- série mignon

Innesto femmina ad inserto-serie mignon



DN	Ø NIPPLE Ø ESPIGA	Part nº Referencia	€
4	4 mm	115 4	9,53
6	6 mm	115 6	9,53
8	8 mm	115 8	9,53

Enchufe Mignon hembra-push-on

Coupling Mignon female-push-on

Coupleur femelle à tube- série mignon

Innesto femmina a tubo-serie mignon



PIPE TUBO	Part nº Referencia	€
6/4 mm	114 6/4	10,12
8/6 mm	114 8/6	10,12

Enchufe Mignon macho-push-on

Coupling Mignon male - push-on

Coupleur mâle à tube- série mignon

Innesto mascho a tubo-serie mignon



PIPE TUBO	Part nº Referencia	€
6/4 mm	214 6/4	2,62
8/6 mm	214 8/6	2,77

Enchufe Mignon hembra-H BSP cilíndrico

Female socket-serie mignon

Coupleur femelle à femelle- série mignon

Innesto femmina a fileto femmina-serie mignon



THREAD ROSCA	Part nº Referencia	€
1/8	112 1/8	6,56
1/4	112 1/4	6,41
3/8	112 3/8	6,75

Enchufe Mignon macho-H BSP cilíndrico

Coupling Mignon male-F BSP parallel

Coupleur mâle à femelle- série mignon

Innesto mascho a fileto femmina-serie mignon



THREAD ROSCA	Part nº Referencia	€
1/8	212 1/8	1,32
1/4	212 1/4	2,00
3/8	212 3/8	2,02

Enchufe Mignon macho-espiga

Coupling Mignon male-hose tail

Coupleur mâle à douille- série mignon

Innesto mascho ad inserto-serie mignon



DN	Ø NIPPLE Ø ESPIGA	Part nº Referencia	€
6	6 mm	215 6	1,65
4	4 mm	215 4	1,65
8	8 mm	215 8	2,00

Enchufe Mignon hembra-push-on c/muelle

Coupling Mignon female - push-on w/nut+spring

Coupleur femelle à tube ressort- série mignon

Innesto femmina a tubo molla-serie mignon



PIPE TUBO	Part nº Referencia	€
6/4 mm	113 6/4	11,80
8/6 mm	113 8/6	11,80

Enchufe Mignon macho-push-on c/muelle

Coupling Mignon male - push-on w/nut+spring

Coupleur mâle à tube ressort- série mignon

Innesto mascho a tubo molla-serie mignon



PIPE TUBO	Part nº Referencia	€
6/4 mm	213 6/4	4,07
8/6 mm	213 8/6	4,29

Enchufes mini - serie uni ISO 6150 B-12

Mini-serie uni ISO 6150 B-12

Coupleurs mini - série uni ISO 6150 B-12

Innesti Mini-serie uni ISO 6150 B-12

Enchufe UNI ISO 6150 B-12 hembra-M BSP

Coupling UNI ISO 6150 B-12 female-M BSP

Coupleur femelle à mâle- série uni ISO 6150 B-12

Innesto femmina a filetto maschio-serie UNI ISO 6150 B-12



THREAD ROSCA	Part n° Referencia	€
1/4	121 1/4	5,12
3/8	121 3/8	6,02
1/2	121 1/2	6,18

Enchufe UNI ISO 6150 B-12 hembra-H BSP

Coupling UNI ISO 6150 B-12 female-F BSP

Coupleur femelle à femelle- série uni ISO 6150 B-12

Innesto femmina a filetto femmina-serie UNI ISO 6150 B-12



THREAD ROSCA	Part n° Referencia	€
1/4	122 1/4	5,12
3/8	122 3/8	6,02
1/2	122 1/2	6,02

Enchufe UNI ISO 6150 B-12 macho-M BSP

Coupling UNI ISO 6150 B-12 male-M BSP

Coupleur mâle à mâle- série uni ISO 6150 B-12

Innesto maschio a filetto maschio-serie UNI ISO 6150 B-12



THREAD ROSCA	Part n° Referencia	€
1/4	221 1/4	0,79
3/8	221 3/8	1,24
1/2	221 1/2	1,93

Enchufe UNI ISO 6150 B-12 macho-H BSP

Coupling UNI ISO 6150 B-12 male-F BSP

Coupleur mâle à femelle- série uni ISO 6150 B-12

Innesto maschio a filetto femmina-serie UNI ISO 6150 B-12



THREAD ROSCA	Part n° Referencia	€
1/4	222 1/4	0,93
3/8	222 3/8	1,39
1/2	222 1/2	2,39

Enchufe UNI ISO 6150 B-12 hembra-espiga

Socket with rest for rubber hose-serie UNI ISO 6150 B-12

Coupleur femelle à douille- série UNI ISO 6150 B-12

Innesto femmina ad inserto-serie UNI ISO 6150 B-12



DN	Ø NIPPLE Ø ESPIGA	Part n° Referencia	€
6	6 mm	125 6	5,89
8	8 mm	125 8	6,03
10	10 mm	125 10	6,24
12	12 mm	125 12	6,32

Enchufe UNI ISO 6150 B-12 macho-espiga

Coupling UNI ISO 6150 B-12 male-hose tail

Coupleur mâle à douille- série UNI ISO 6150 B-12

Innesto maschio ad inserto-serie UNI ISO 6150 B-12



DN	Ø NIPPLE Ø ESPIGA	Part n° Referencia	€
6	6 mm	225 6	1,24
8	8 mm	225 8	1,42
10	10 mm	225 10	1,49
12	12 mm	225 12	1,76

Enchufe UNI ISO 6150 B-12 macho-push-on c/muelle

Coupling UNI ISO 6150 B-12 male-push-on w/ nut+spring

Coupleur mâle à tube ressort- série UNI ISO 6150 B-12

Innesto maschio a tubo molla-serie UNI ISO 6150 B-12



PIPE TUBO	Part n° Referencia	€
6/4 mm	223 6/4	4,56
8/6 mm	223 8/6	4,81
10/8 mm	223 10/8	5,35
12/10 mm	223 12/10	5,97

Enchufes mini - serie multipresa

Mini-serie multipress

Coupleurs mini - série multiprise

Innesti Mini-serie uni Multipresa

Enchufe multipresa hembra-M BSP

Coupling multisocket female-M BSP

Coupleur femelle à mâle- série multiprise

Innesto femmina a filetto maschio-serie multipress



THREAD ROSCA	Part n° Referencia	€
1/4	191 1/4	12,41
3/8	191 3/8	12,41
1/2	191 1/2	13,36

Enchufe multipresa hembra-H BSP

Coupling multisocket female-F BSP

Coupleur femelle à femelle- série multiprise

Innesto femmina a filetto femmina-serie multipress



THREAD ROSCA	Part n° Referencia	€
1/4	192 1/4	13,25
3/8	192 3/8	13,25
1/2	192 1/2	14,22

Enchufe multipresa hembra-espiga

Coupling multisocket female-hose tail

Coupleur femelle à douille- série multiprise

Innesto femmina ad inserto-serie multipress



DN	Ø NIPPLE Ø ESPIGA	Part n° Referencia	€
6	6 mm	195 6	13,25
8	8 mm	195 8	13,25
10	10 mm	195 10	13,25
12	12 mm	195 12	13,25

Enchufe multipresa hembra-push-on

Coupling multisocket female-push-on

Coupleur femelle à tube- série multiprise

Innesto femmina a tubo-serie multipress



PIPE TUBO	Part n° Referencia	€
6/4 mm	194 6/4	13,43
8/6 mm	194 8/6	13,75
10/8 mm	194 10/8	13,75

Enchufe multipresa hembra-push-on c/muelle

Coupling multisocket female-push-on w/
nut+spring

Coupleur femelle avec ressort- série multiprise

Innesto femmina con molla-serie multipress



PIPE TUBO	Part n° Referencia	€
6/4 mm	193 6/4	17,44
8/6 mm	193 8/6	18,02
10/8 mm	193 10/8	18,02

Normativa | Standard | Standard

41 ENCHUFE PARA NORMATIVAS



1 socket for 4 standards
1 corps pour 4 embouts

Ø 5,5 mm



SUECA / SWEDISH / SUEDOISE

Ø 7,5 mm



EUROPEA / EUROPEAN / EUROPEENNE

Ø 5 mm



ITALIANA / ITALIAN / ITALIENNE

Ø 5,5 mm



UNI ISO 6150 B-12

Enchufes rápidos ESTO

Quick release couplings "ESTO"
Coupleurs rapides type ESTO
Innesti rapidi tipo ESTO

Enchufe Esto hembra 1/4

Coupling Esto female 1/4

Coupleur femelle 1/4

Innesto hembra 1/4



THREAD ROSCA	Ø NIPPLE Ø ESPIGA	Part n° Referencia	€
M 1/4" BSPT	-	ESTO 110	22,95
M 3/8" BSPT	-	ESTO 140	23,76
M 1/2" BSPT	-	ESTO 142	23,76
F 1/4" BSP	-	ESTO 120	22,95
F 3/8" BSP	-	ESTO 150	23,76
-	8 mm	ESTO 130	24,73
-	10 mm	ESTO 131	24,73

Enchufe Esto ECO hembra 1/4

Coupling Esto ECO female 1/4

Coupleurs 1/4 ECO

Innesto 1/4 ECO



THREAD ROSCA	Ø NIPPLE Ø ESPIGA	Part n° Referencia	€
M 1/4" BSPT	-	ESTO 1110	21,05
M 3/8" BSPT	-	ESTO 1140	21,39
M 1/2" BSPT	-	ESTO 1142	21,39
F 1/4" BSP	-	ESTO 1120	21,05
F 3/8" BSP	-	ESTO 1150	21,39
F 1/2" BSP	-	ESTO 1152	23,47
-	8 mm	ESTO 1130	22,35
-	10 mm	ESTO 1131	22,35
-	12/13 mm	ESTO 1132	22,35
-	6 mm	ESTO 1136	22,35

Enchufe Esto hembra 3/8

Coupling Esto female 3/8

Coupleur femelle 3/8

Innesto femmina 3/8



THREAD ROSCA	Ø NIPPLE Ø ESPIGA	Part n° Referencia	€
M 3/8" BSPT	-	ESTO 310	40,77
M 1/2" BSP	-	ESTO 312	40,77
F 3/8" BSP	-	ESTO 320	41,96
-	12 mm	ESTO 330	41,58

Enchufe Esto hembra 1/2

Coupling Esto female 1/2

Coupleur femelle 1/2

Innesto femmina 1/2



THREAD ROSCA	Part n° Referencia	€
M 1/2" BSPT	ESTO 210	54,65
F 1/2" BSP	ESTO 220	54,65

Enchufe Esto macho 1/4

Coupling Esto male 1/4

Coupleur embout mâle 1/4

Innesto maschio 1/4



THREAD ROSCA	Ø NIPPLE Ø ESPIGA	Part n° Referencia	€
M 1/4" BSPT	-	ESTO 160	5,27
M 3/8" BSPT	-	ESTO 163	6,50
M 1/2" BSPT	-	ESTO 162	11,51
F 1/4" BSP	-	ESTO 170	5,27
F 3/8" BSP	-	ESTO 173	6,91
-	6 mm	ESTO 181	5,27
-	8 mm	ESTO 180	5,27
-	10 mm	ESTO 182	5,27

Enchufe Esto macho 3/8

Coupling Esto male 3/8

Coupleur embout mâle 3/8

Innesto maschio 3/8



THREAD ROSCA	Ø NIPPLE Ø ESPIGA	Part n° Referencia	€
M 3/8" BSPT	-	ESTO 360	9,25
F 3/8" BSP	-	ESTO 370	9,25
-	12 mm	ESTO 380	9,54

Enchufe Esto macho 1/2

Coupling Esto male 1/2

Coupleur embout mâle 1/2

Innesto maschio 1/2



THREAD ROSCA	Part n° Referencia	€
M 1/2" BSPT	ESTO 260	11,44
F 1/2" BSP	ESTO 270	13,37

COMPONENTES NEUMÁTICOS

PNEUMATIC COMPONENTS

GRUPO COMPLETO · COMPLETE GROUP

ELEMENTOS · ELEMENTS

- FILTRO · FILTER
- REGULADOR · PRESSURE REDUCERS
- LUBRICADOR · LUBRICANTS
- MANÓMETRO · PRESURE GAUGES
- SOPORTE · SUPPORT



TRATAMIENTO DE AIRE COMPRIMIDO

COMPRESSED AIR TREATMENT



MANIOBRAS · MANEUVERS

ACCIONAMIENTOS: ELÉCTRICO, MANUAL, MECÁNICO, NEUMÁTICO

DRIVES: ELECTRIC, MANUAL, MECHANICAL, PNEUMATIC

PISTOLA / SILENCIADOR / NEBULIZADOR

GUN / SILENCER / NEBUIZER

ACCESORIOS · ACCESSORIES

VÁLVULAS · VALVES:

- BOLA · BALL
- REGULADOR · REGULATOR
- ANTIRETORNO · NON-RETURN
- ESCAPE RÁPIDO · QUICK EXHAUST
- SEGURIDAD · RELIEF



VÁLVULAS DE CONTROL

CONTROL VALVES



VÁLVULAS COMPLETAS · COMPLETE VALVES

- LATÓN · BRASS
- INOX · STAINLESS STEEL

ACCESORIOS · ACCESSORIES

- BOBINAS · COILS
- CONECTORES · CONNECTORS
- MEMBRANAS · MEMBRANES
- ...

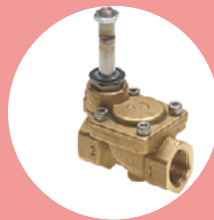

VÁLVULAS DE CORTE

LOW PRESSURE VALVES



CILINDROS COMPLETOS · COMPLETE CYLINDERS

- ISO 1552
- ISO 6432
- DOBLE EJE · DOUBLE-SHAFT

ACCESORIOS · ACCESSORIES

- HORQUILLAS · ROD CLEVIS
- RÓTULAS · OSCILLATING EYE
- CHARNELAS · PIVOTS
- ...



CILINDROS COMPLETOS

COMPLETE CYLINDERS



VER CATÁLOGO DE COMPONENTES HIDRÁULICOS Y NEUMÁTICOS

SEE OUR HYDRAULIC AND PNEUMATIC COMPONENTS CATALOGUE

Condiciones de venta

General conditions of sale

GENERALIDADES

Estas condiciones así como las eventuales condiciones especiales acordadas en el contrato rigen para todas las entregas y todas las prestaciones. Las condiciones de compra del cliente que sean distintas a las aquí establecidas no llegarán a formar parte del contrato al aceptar el pedido. Los contratos se celebran, salvo en el caso de que se haya acordado lo contrario, mediante confirmación escrita del proveedor. En ningún caso, las Condiciones Generales y/o Específicas de Compra del Comprador, anularán o sustituirán estas Condiciones Generales de Venta.

La aceptación de nuestras ofertas implica tácitamente la de todas las condiciones aquí detalladas, salvo las especiales acordadas por escrito, particularmente en la misma Oferta o detalladas en nuestro acuse de recepción de pedido, únicos documentos que nos obligan ante el Cliente.

DICSA se reserva el derecho de propiedad intelectual y el derecho de propiedad intelectual de muestras, presupuestos, planos e información en forma material o inmaterial así como en forma electrónica; el acceso de terceros a éstos ha de impedirse.

OFERTAS Y PEDIDOS

Los precios se entienden, caso de no expresar lo contrario para mercadería situada en nuestro almacén, incluyendo el cargado de ésta, pero sin incluir el embalaje ni el transporte al lugar de recepción, ni impuestos –que serán siempre a cargo del comprador-, así como tampoco la puesta en marcha en el emplazamiento. Todas las operaciones de transporte, seguro, manutención y entrega son a cuenta y riesgo del Comprador.

Las ofertas incluyen solamente los materiales y artículos en ellas especificados disponibles en stock salvo agotamiento y por el plazo de validez determinado en las mismas.

Los estudios u ofertas de material están basados en los precios vigentes en la fecha de su realización, y si, debido a alteraciones en el coste de los materiales, modificación de aranceles o a cualquier otra causa, el nivel de precios fuese revisado, los precios que se aplicarían serían aquellos que rijan en la fecha del suministro, a menos que la oferta sea aceptada dentro del plazo de validez que en la misma se fije.

Los precios no incluyen, excepto notificación expresa, el montaje y la puesta en marcha de los materiales suministrados, los fluidos recomendados por los servicios técnicos de los fabricantes, los contenedores tanto rígidos como elásticos de los materiales, así como el estudio de implantación de los distintos materiales.

DICSA podrá variar el precio, como consecuencia de cualquier ley que afecte a materiales, salarios o a las horas de trabajo y también a posible cambios en la paridad de la moneda, en elementos de importación.

Los pedidos no serán tomados en consideración a menos que vengan acompañados de la cantidad a cuenta prevista en nuestra Oferta, si así se ha establecido. La aceptación de la Oferta supondrá igualmente la aceptación sin reservas de estas Condiciones Generales de Venta.

ESTUDIOS, PLANOS Y DISEÑOS

La información relacionada con la oferta, tal como planos, diseños, dibujos catálogos y/u otra documentación técnica, es solamente informativa y tienen como objeto dar una imagen general de los materiales en ellos descritos, no formando parte del contrato a menos que haya habido algún acuerdo por escrito. DICSA no aceptará ningún tipo de responsabilidad por la inexactitud u omisión de dicha documentación.

El Cliente deberá hacer siempre un estudio previo de compatibilidad y de montaje de los elementos en su instalación y será el único responsable de la puesta en conformidad de dicha instalación con las distintas reglamentaciones vigentes.

En presupuestos, planos, esquemas y otras informaciones técnicas, mantendremos reservado el derecho de propiedad y de realización, no permitiendo que estos sean facilitados a terceros sin nuestro previo consentimiento escrito.

DICSA se reserva el derecho de propiedad de la mercancía suministrada hasta el pago completo del precio establecido. DICSA se reserva el derecho de propiedad de los planos de la mercancía, que no serán facilitados ni vendidos a terceros en ningún caso.

TRABAJOS IN SITU

Los presupuestos de los trabajos realizados en el lugar de la obra del cliente son considerados orientativos, debido a las características particulares y especiales que pueden representar, no pudiendo dar lugar, excepto acuerdo definitivo entre las partes, en precios definitivos.

REPARACIÓN

Los trabajos de reparación no se empezarán hasta la aceptación escrita, por parte del Cliente, del presupuesto y de las condiciones que se establezcan.

En el supuesto de que el presupuesto no sea aceptado por el Cliente en el plazo de un mes, los gastos derivados del desmontaje, almacenaje, peritaje y portes correrán a cargo del Cliente. Si el Cliente solicita la reparación antes de aceptar el presupuesto, los trabajos se llevarán a cabo lo antes posible y, por su parte, el Cliente deberá aceptar el coste final de la reparación.

En caso de entregarse productos nuevos a cambio de la reparación, si esta estuviera fuera de garantía el Cliente deberá aceptar el cargo correspondiente a la misma.

GENERAL TERMS

These conditions, together with the eventual specific conditions accorded in the contract, apply to all deliveries and all services. The purchase conditions of the customer, if different from those herein established, will not be part of the contract on having accepted the order.

The contracts are concluded, unless otherwise agreed upon by the Parties in writing, by means of written confirmation of the supplier. The General Conditions and/or Specific Conditions of Purchase of the Buyer, cannot, in no case, cancel or replace these General Conditions of Sale.

The acceptance of our offers implies tacitly the acceptance of all the conditions detailed herein, except the special ones that have the agreement in writing, particularly in the same offer or detailed in our accuse of receipt of order, the only documents that oblige us before the Customer. DICSA has the right of property and the right of intellectual property of samples, budgets, technical documentation and information in material or immaterial form as well as in electronic form; the access of third parties to these documents must be forbidden.

OFFERS AND ORDERS

Except in case of having expressed the opposite, the prices include the merchandise placed in our store, including its loading, but without including the packing nor the transport to the place of receipt, nor taxes, nor the getting started - these will always be at the expense of the customer. All the operations of transport, insurance, handling and delivery are on the account and risk of the Customer.

The offers include only the materials and products expressed in them, available in stock until end of stock, with the term of validity expressed in the same offers.

The studies or offers of material are based on the prices on the date the offer was made, and if, due to changes in the cost of the materials, modification of duties or to any other reason, the level of prices was checked, the prices that would be applied would be those that apply in the date of the delivery, unless the offer is accepted in the term of validity expressed in it.

The prices do not include, unless specific notification, the assembly and the getting started of the supplied materials, the fluids recommended by the technical services of the suppliers, the containers of the materials, as well as the study of the setting up of the different materials. DICSA may change the price, as a consequence of any law that concerns materials, wages, or the working hours, but also as a consequence of probable changes in the parity of the currency since it concerns the elements of import.

The orders will not be taken in consideration unless they are provided with the specific amount in our account, foreseen in our Offer, if this condition has been pre-established. The acceptance of the Offer will suppose equally the acceptance without reserve of these General Conditions of Sale.

STUDIES, TECHNICAL DOCUMENTATION

The information related to the offer, as technical documentation, designs, drawings, catalogues and / or any other technical documentation, is only informative and they have as object to give a general image of the materials described in them, they do not form a part of the contract unless written agreement. DICSA will not accept any type of responsibility for inaccuracy or omission of the above mentioned documentation.

The Customer will always have to do a previous study of compatibility and of assembly of the elements in his installation and will be the only responsible for the putting in conformity of the above mentioned installation with the current regulations. In offers, drawings, schemes and other technical information, we reserve ourselves the right of property and of design, not allowing that these should be facilitated to third parties without our previous written assent.

DICSA retains the property of the supplied merchandise until full payment of the agreed price. DICSA also retains the property of the Product's project, which in no circumstances shall be disclosed or sold to third parties.

THE ASSEMBLIES AT THE LOCATION (PLANT) OF THE CUSTOMER

The offers of the assemblies done for the customer, in his elected location of work, are considered as an estimate (approximate calculation), due to the particular and special characteristics that they can represent, not being able to give place, except final agreement between the parts, to final prices.

REPAIRMENT

The works of repair will not begin until written acceptance, on the part of the Customer, of the offer and of the conditions established in it. Supposing that the offer is not accepted by the Customer within one month, the expenses derived from the disassembly, storage, survey and freightage will be chargeable to the Customer. If the Customer requests the repair before accepting the offer, the assemblies will be carried out as soon as possible and, for his part, the Customer will have to accept the final cost of the repair.

In case of delivery of new products in exchange for the repair, if this one was out of guarantee, the Customer will have to accept the payment corresponding to it. The budgets of repair are always as estimation and should not be considered as final prices.

DELIVERY TERMS

DICSA saves itself the right to reject an order depending on the availability of the products. In this supposition, DICSA will communicate it to the Customer as promptly as possible.

Condiciones de venta

General conditions of sale

Los presupuestos de reparación siempre son orientativos y en ningún caso deben tomarse como precios finales.

PLAZOS DE ENTREGA

DICSA se reserva la facultad de rechazar un pedido en función de la disponibilidad de los productos. En este supuesto, lo comunicará al comprador con la mayor brevedad posible.

El plazo de entrega será acordado por las partes contractuales. Los plazos de entrega se calcularán desde la fecha de recepción de la confirmación del pedido, pudiendo DICSA proceder sin interrupción alguna. DICSA no será responsable de las demoras en el suministro de toda o parte de la mercancía en el caso de fuerza mayor, tal como catástrofes naturales, limitaciones legales, huelgas, etc., o cualquier otra causa fuera de nuestro control. En el caso de darse alguna de las razones anteriormente citadas, el periodo de entrega se hará extensible al mismo periodo de tiempo que dure la causa que haya motivado el retraso. Sin embargo, si el periodo excediera de seis meses, DICSA podrá cancelar la parte no enviada notificando previamente por escrito al comprador.

Procuramos con el mayor interés, cumplir los plazos de entrega que se indican en nuestras ofertas o en nuestras confirmaciones de pedido, si bien es materialmente imposible responder plenamente de dicho cumplimiento, por depender de otros proveedores y de inesperadas circunstancias totalmente ajenas a nuestro posible control.

De ahí que no se aceptarán sanciones por demora en la entrega prevista.

DERECHO DE PROPIEDAD

DICSA mantiene la propiedad de la mercancía hasta que el comprador realice el pago por completo de la misma.

Será responsabilidad del comprador tomar las medidas necesarias para conservar en buen estado la mercancía hasta que haya sido pagada, debiendo asegurarse a DICSA el cobro de la misma en caso de haber sido vendida a terceras personas por el comprador.

GARANTÍA

No se responderá de ninguna reclamación que no sea efectuada dentro de los 12 meses siguientes a la entrega de la mercancía, ni se aceptarán devoluciones sin autorización previa o pasados 15 días desde la entrega de la mercancía. En cualquier caso, toda devolución deberá ir acompañada de copia de nuestra autorización y, siempre que no sea por causas imputables a DICSA, conllevará un recargo mínimo del 20 % sobre el coste del material devuelto, corriendo todos los gastos a cargo del cliente.

En relación con los defectos que aparezcan en los productos suministrados, DICSA aceptará como única responsabilidad u obligación, abonar la pieza o piezas defectuosas siempre que la mercancía haya sido tratada adecuadamente y que los defectos surgidos sean debidos a defectos de material o fabricación.

La garantía comprende la reposición o reparación de los elementos defectuosos a realizar en nuestros talleres.

La garantía se entiende siempre con el material presumiblemente defectuoso depositado en nuestras instalaciones, con los gastos de transporte y riesgo a cargo del comprador.

Los consejos y asesoramiento dados antes y post cierre del contrato, se realizan con la mejor intención y según nuestros máximos conocimientos, no obstante DICSA no asume ninguna clase de responsabilidades a este respecto, ni responderá de los eventuales daños directos o indirectos que indistintamente, por quién, dónde y por qué puedan producirse.

DICSA no será responsable de ninguna consecuencia o ningún daño indirecto producido al Comprador o a terceros, incluyendo los daños de pérdida de oportunidades, negocio o ingresos.

DICSA garantiza exclusivamente sus materiales excluyendo cualquier responsabilidad por los efectos o perjuicios que estos puedan provocar en instalaciones, maquinarias o circuitos. En ningún caso se responsabilizará de los accidentes personales o materiales y pérdidas de producción.

Se excluye de la garantía las averías producidas por mal uso o deficiente instalación, averías provocadas por sometimiento de los equipos a esfuerzos anormales con fines experimentales, de ajuste o prueba. La total responsabilidad de DICSA por los daños causados, independientemente del tipo de acción o teoría de la responsabilidad, no excederá del importe de la obra, instalación o materiales que haya sido objeto de pedido a DICSA. Cualquier importe que supere dicha cantidad y que DICSA se vea obligada a soportar ya sea por decisión judicial, arbitral o similar, será repetida a la compradora hasta lograr indemnidad.

Se encuentran excluidos de esta garantía:

- El uso de instalaciones o servicios, que se aparten de los manuales de instrucción o especificaciones de DICSA.
- El uso inadecuado de instalaciones o negligencia del Comprador, sus Ayudantes o Agentes.
- Las partes suministradas por el Comprador.

PORTES

La mercancía se entiende siempre depositada en el domicilio de DICSA, incluso en operaciones condicionadas a la entrega en destino y la mercancía siempre

The delivery time has to be approved by the contractual parts. The delivery time will be calculated from the date of receipt of the confirmation of the order, when DICSA will be able to proceed without any interruption. DICSA will not be responsible for the delays in the supply of all or in part of the goods in case of major force, such as natural catastrophes, legal limitations, strikes, etc., or any other reason beyond our control. In case of any of the reasons previously mentioned, the period of delivery will be extensible to the same period of time that lasts the reason that has motivated the delay. Nevertheless, if the period exceeds six months, DICSA may cancel the part that couldn't be sent, by previously notifying the Customer in writing.

We do our best to respect the delivery times that are indicated in our offers or in our order confirmations, though it is materially impossible to answer completely for the above mentioned fulfillment, since we depend on other suppliers and on unexpected circumstances totally foreign to our possible control. Won't be accepted any sanctions for the delay in the foreseen delivery.

RIGHT OF PROPERTY

DICSA maintains the property of the materials (products) until the Customer makes the payment in full of the merchandise.

The Customer is responsible for taking the necessary actions to preserve in good condition the merchandise until it has been paid, must insure DICSA of the payment of the same one in case of having being sold to third persons by the Customer.

WARRANTY

We won't attend any claim done after the 12 months following the delivery of the merchandise. Returned material will not be allowed without previous authorization or when the time between the purchase and the request for return exceeds 15 days.

In any case, all returned merchandise will have to be accompanied by a copy of our authorization and, providing that it is not for reasons attributable to DICSA, will carry a minimal surcharge of 20 % on the cost of the returned material, all the expenses will be charged to the customer. Concerning the faults that appear in the supplied products, DICSA will only accept as unique responsibility or obligation, the paying of the product or defective products providing that the products (merchandise) have been treated adequately and that the arisen faults are due to faults of material or manufacture.

The warranty includes the replacement or repair of the defective elements in our workshops. The warranty is understood always in relation with the presumably defective material deposited in our warehouse, but the costs of transport and the risk being at the expense of the Customer. The advices given before and post closing of the contract, are made with the best intention and according to our know-how, nevertheless DICSA does not assume any category of responsibilities in this regard, nor will answer of the eventual direct or indirect damages that could take place indistinctly, no matter who, where and why they may take place.

DICSA will not be responsible for any consequence or indirect damages occurred to the Customer, and / or third Parties including but not limited to loss of opportunities, business and incomes.

DICSA guarantees exclusively its own materials, excluding any responsibility for the effects or damages that these could provoke in facilities, equipments or conductions. In no case will take responsibility for accidents related to individuals or materials or for losses in fabrication.

The warranty excludes the breakdowns produced by badly use or deficient installation, breakdowns provoked by overloading of the equipments for experimental purposes, either for adjustment or testing. DICSA's total responsibility for the caused damages, independently of the type of action or theory of the responsibility, will not exceed the amount of the work done, installation or materials that have been object of the order to DICSA.

Any amount that exceeds the above mentioned quantity, and any amount that DICSA will have to support either for judicial, arbitral or similar decision, will be transmitted to the Customer until obtaining indemnity.

Will be excluded from this warranty:

- *The use of facilities or services, which are different of those included in the manuals of instruction or in DICSA's specifications.*
- *The inadequate use of facilities or negligence of the Customer, his Assistants or Agents.*
- *The parts supplied by the Customer.*

FREIGHTAGES

By merchandise we always mean the one deposited in DICSA's warehouse, even in operations conditioned by the delivery at destination and the merchandise will always travel at the account and risk of the Customer, being at his charge, including the additional insurances that could be established and the special permissions it may need. According to what it is established in the article 18 of the Royal decree 782/1998 concerning wrapping and packaging mentioned in the 1st additional Disposition (Regulation) of the Law 11/1997, the person responsible for the delivery of the residues of the packaging and worn packages, for the correct environmental management, will be the final user.

EMERGENCY DELIVERIES

No matter the type of the transportation used: by plane, courier, as baggage (luggage), special agencies, messengers etc; independently of the amount of the above mentioned service, the Customer will pay all the extra expenses, those of trans-

Condiciones de venta

General conditions of sale

viajará por cuenta y riesgo del comprador, siendo a su cargo inclusive los seguros adicionales que pudieran establecerse y los permisos especiales a que hubiera lugar.

Según se establece en el artículo 18 del Real Decreto 782/1998 para los envases y embalajes acogidos a la Disposición adicional 1.ª de la Ley 11/1997, el responsable de la entrega de los residuos de los embalajes y envases usados, para su correcta gestión ambiental, será el usuario final.

ENVÍOS DE EMERGENCIA

Sea cual fuere el medio de transporte utilizado, avión, courier, régimen de equipajes, agencias especiales, mensajeros etc. Independientemente del importe de dicho servicio, el comprador correrá con todos los gastos extra, los de acarreo, de desplazamientos, y de comunicaciones que el servicio haya ocasionado, sin que en ningún caso este valor pueda ser inferior a 60 euros.

PEDIDOS ESPECIALES

Todo pedido de material especial, conllevará el pago anticipado del 50 % del importe del pedido, como condición indispensable para su aceptación. Dicho importe quedará siempre a favor de DICSА como indemnización en cualquier caso de anulación por parte del comprador, sin perjuicio de las reclamaciones que por Ley se puedan tener derecho.

VENTA MÍNIMA

La facturación mínima será de 50 € sea cual sea el importe del pedido.

PAGOS

Los pagos se realizarán como máximo y salvo acuerdo expreso entre las partes, a 60 días desde la fecha de la factura y previa recepción de los informes positivos de crédito. Si el comprador no efectuare el pago de cualquiera de los suministros a su vencimiento, DICSА está autorizado a suspender los envíos posteriores hasta que se realice dicho pago. Cualquier cargo bancario asociado con el pago de la mercancía, así como los gastos de devolución de efectos en caso de impago, serán por cuenta del comprador.

En caso de demora en el pago y sin perjuicio de otros derechos atribuidos al comprador por la legislación en vigor, el comprador abonará a DICSА un interés de demora del 2 % mensual desde la fecha de vencimiento de la factura.

COBRO DE LETRAS O RECIBOS DEVUELTOS O APLAZADOS

Serán a cargo del librado:

- Gastos de devolución.
- Intereses del 1 % mensual desde el día del vencimiento fallido hasta la fecha de cobro definitivo.
- Posible valor del timbre de nuevos documentos.
- Prima de seguro de crédito.

PAGOS COINCIDENTES EN VACACIONES

Si el cliente no pudiese atender los pagos que coincidiesen con periodos vacacionales, éstos se trasladarán al mismo día del mes anterior. En caso de existir días fijos de pago, el vencimiento se trasladará al día hábil de pago inmediatamente anterior.

USO DE SOFTWARE

En la medida en que el volumen de entrega incluye la puesta a disposición de software, el cliente tiene el derecho no exclusivo a usarla incluyendo la documentación adjunta. Se le cede el software para el uso en el objeto de entrega al cual va destinado. No se admite el uso de este software en otro sistema. La modificación, traducción o adaptación de código de objeto a código de origen así como la reproducción de software solamente se admite en la medida legalmente establecida. El cliente se compromete a no retirar las indicaciones del fabricante, especialmente indicaciones del Copyright sin el consentimiento previo de DICSА. Todos los demás derechos sobre el software y la documentación incluyendo las copias, corresponden a DICSА o al proveedor del software. No se admite la concesión de sublicencias.

DERECHO APLICABLE Y JURISDICCIÓN

Las relaciones jurídicas entre DICSА y el comprador están sujetas al derecho Español. El tribunal competente será el del domicilio de DICSА. Sin embargo, DICSА podrá optar por interponer las acciones legales correspondientes en el domicilio del comprador.

portations, of shipping, and of communications that the service has caused; this value may not, under no circumstance, be lower than 60 euros.

SPECIAL ORDERS

Any order (request) of special material, will carry the anticipated payment of 50 % of the amount of the order (request), as an indispensable condition for its acceptance. The above mentioned amount will always be in favor of DICSА as compensation in case of cancellation on the part of the Customer, without prejudice of the claims at which they may have right by Law.

MINIMAL SALE

The minimal invoice will be of 50 €, no matter the amount of the order.

PAYMENTS

The payments have to be done, except express written agreement between the parts, in maximum 60 days from the date of the invoice and previous receipt of the positive reports of credit. If the Customer doesn't make the payment in time, for a part of the merchandise supplied, DICSА is authorized to suspend the posterior deliveries until the Customer executes the due payments. Any bank charges associated with the payment of the merchandise, as well as the expenses of return of it in case of non-payment, will be at the expense of the Customer. In case of delay in the payment and without prejudice of other rights attributed to the buyer for the legislation in effect, the Customer will pay to DICSА an interest of monthly delay of 2 % starting from the date when the invoice comes to its term.

UNPAID OR POST-PONED INVOICES

Will be at the expense of the Customer:

- The return expenses.
- Monthly interests of 1 %, from the day when the payment has come to its term and wasn't made, until the date of full payment.
- Possible amount (value) of the stamp of the new documents.
- The credit insurance.

COINCIDENTAL PAYMENTS IN VACATIONS

If the client could not attend to the payments that were coinciding with vacation periods, these will move to the same day of the previous month. In case there are fixed days of payment, the term of the invoice will move to the immediately previous working day of payment.

THE SOFTWARE USE

If the delivery includes the putting at the disposal of the Customer software, the Customer has the exclusive right to use it, including the attached documentation. The software is sent for the use in the object of delivery to which it is destined. It is forbidden the use of this software into any other system. The modification, translation or adjustment of the code of object to code of origin as well as the reproduction of software is only admitted into the legally established limits. The Customer promises not to withdraw the indications of the manufacturer, especially the indications of the Copyright, without DICSА's previous assent. All the other rights on the software and the documentation including the copies, they belong to DICSА or to the supplier of the software. The concession of sublicenses is not admitted.

GOVERNING LAW AND JURISDICTION

These General Conditions and any agreement between DICSА and the Customer shall be exclusively governed by Spanish laws. The exclusive jurisdiction on any dispute between the DICSА and the Customer shall be the courts of DICSА's domicile. Nevertheless, DICSА has also the right to bring legal action against the Customer before the courts of the place of business and/or residence of the Customer.

SOLICITE NUESTRAS **TARIFAS GENERALES** DE PRECIOS



Conducciones Hidráulicas y Neumáticas
Hydraulic and Pneumatic Connectors

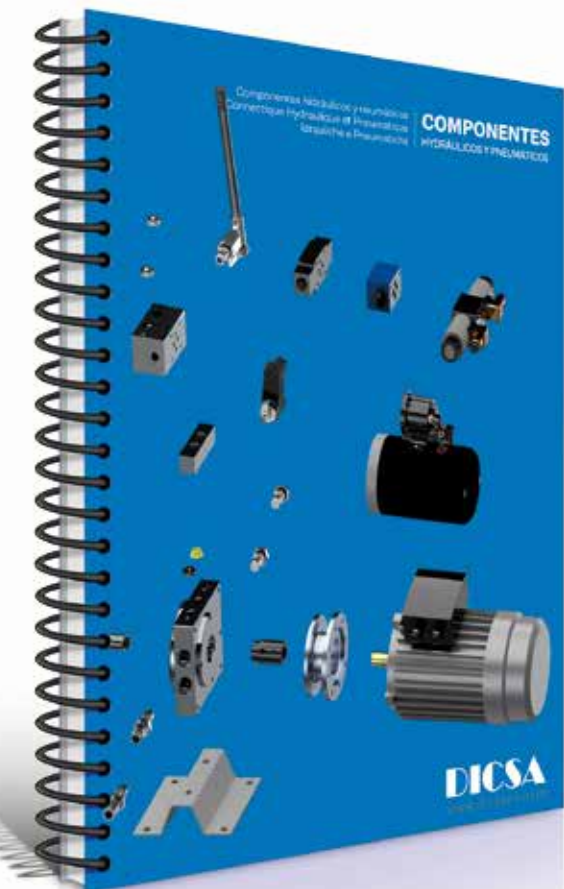

Componentes Hidráulicos y Neumáticos
Hydraulic and Pneumatic Components

PLEASE,
ASK FOR OUR
GENERAL PRICE LISTS

► Información general

General information

DICSA ESPAÑA
Sede | Head Office

Tel. +34 976 46 10 46
Fax +34 976 46 41 04
info@dicsaes.com

DICSA ITALIA SRL

Tel. +39 059 820 179
italia@dicsaes.com

DICSA AMERICA

Tel. 786 358 6662
america@dicsaes.com

DICSA DEUTSCHLAND

Tel. 0322 21098096
export@dicsaes.com

DICSA LATAM

Tel. +34 976 464 106
america@dicsaes.com

DICSA CHINA

Tel. +34 976 464 106
export@dicsaes.com

DICSA TÜRKIYE

Tel. +90 533 080 67 08
turkiye@dicsaes.com

Atención al cliente | Customer service

Departamento comercial | Commercial department

► Nacional | National

Tel. 976 464 108
Fax 976 464 113
comercial@dicsaes.com

► Internacional |
International

Tel. +34 976 464 106
Fax +34 976 464 104
export@dicsaes.com

Gestión de pedidos | Orders management

► Nacional | National

Conducciones | Connectors
Tel. 976 464 100
976 464 101

Hidráulica | Components
Tel. 976 464 102
Fax 976 464 105
pedidos@dicsaes.com

► Internacional |
International

Tel. +34 976 464 100
+34 976 464 101
Fax +34 976 464 104
orders@dicsaes.com

Otros servicios | Other services

► Dpto. Calidad |
Quality Dpt.

Tel. 976 479 545
Fax 876 762 030
calidad@dicsaes.com

► Dpto. Informática |
Computer Dpt.

Tel. 976 479 555
Fax 876 762 030
informatica@dicsaes.com

► Dpto. Producción |
Production Dpt.

Tel. 976 479 543
Fax 876 762 036
produccion@dicsaes.com

► Dpto. Finanzas |
Accounting Dpt.

Tel. 976 479 542
Fax 876 762 029
finanzas@dicsaes.com

► Dpto. Compras |
Purchasing Dpt.

Tel. 976 464 107
Fax 876 762 031
compras@dicsaes.com

► Oficina de almacén |
Warehouse Dpt.

Tel. 976 464 101
Fax 976 464 105
almacen@dicsaes.com



DICSA

info@dicsaes.com
www.dicsaes.com

DISTRIBUIDORA INTERNACIONAL CARMEN, S.A.

Polígono Industrial Alcalde Caballero
C/ Virgen del Buen Acuerdo, s/nº. 50014 Zaragoza (Spain)
Tel. +34 976 46 10 46
Fax +34 976 46 41 04

DICSA ITALIA SRL

Via Emilia Ovest 1179/c
41123 Modena (Italia)
Tel. +39 059 820 179
Fax +39 059 336 52 59
italia@dicsaes.com

DICSA AMERICA LLC

875 NE 191 STR.
STE 302 Aventura. FL 33180
Tel. 786-358-6662
Skype: america.dicsa
Whatsapp: +34 617548815
america@dicsaes.com

DICSA DEUTSCHLAND

Logististikzentrum GmSH
Thomas Dachser Str. 1 ·
76316 Malsch (Alemania)
Tel. 322 21098 096
export@dicsaes.com

DICSA LATAM

Tel. +34 976 464 106
america@dicsaes.com

DICSA CHINA

Tel. +34 976 464 106
export@dicsaes.com

DICSA TÜRKIYE

Tel. 90 533 080 67 08
turkiye@dicsaes.com